

ARNO[®]

WERKZEUGE

We have a passion for precision.

VHM-/PM-HSS WERKZEUGE

Solid carbide-/PM-HSS Tools

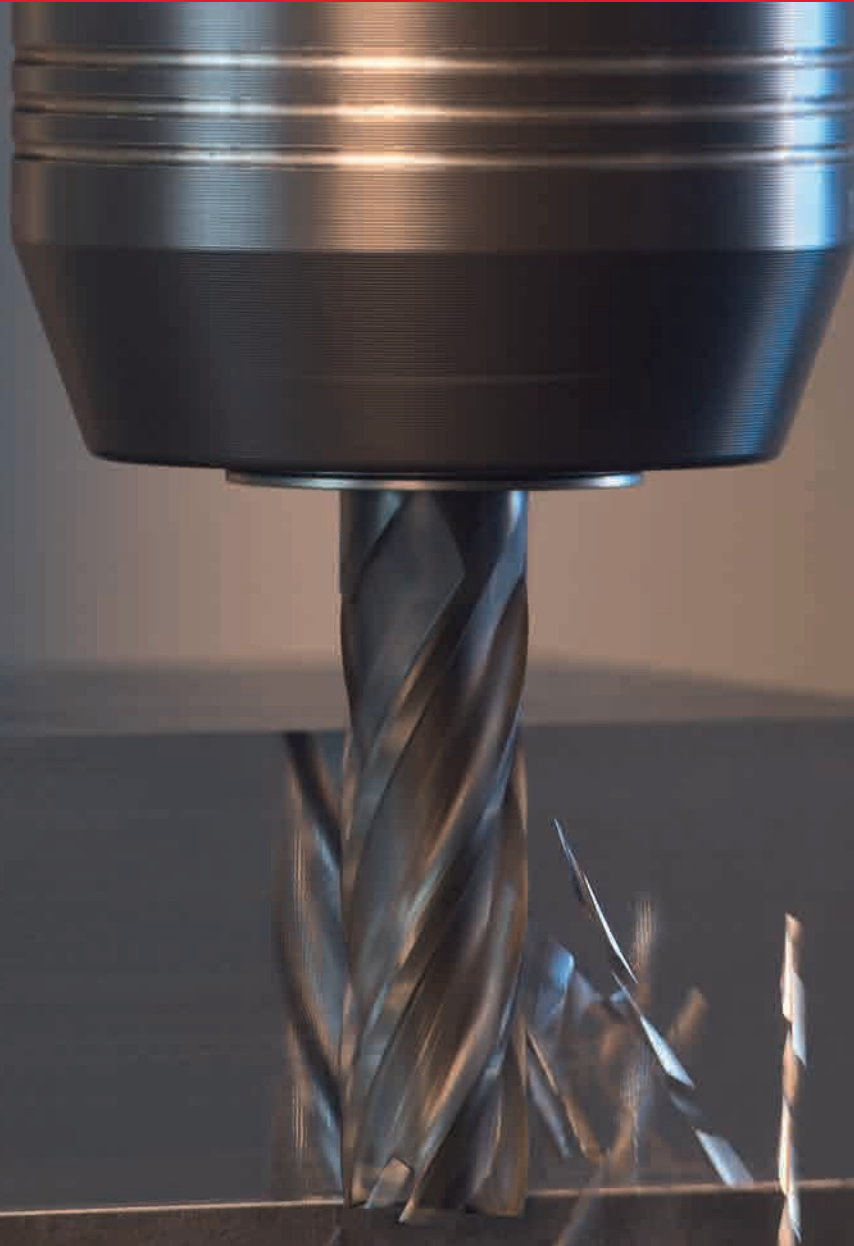

**Hochleistungswerkzeuge
zum Fräsen und Bohren**

*High performance tools
for milling and drilling*

www.arno.de



ARNO® – Vollhartmetall-Schaftfräser / Solid carbide end-mills



Seite / Page
13 – 305

ARNO® – PM-HSS-Fräser / PM-HSS milling cutters

(Pulvermetallurgische HSS-Fräser / Powder metallurgy and HSS milling cutters)



Seite / Page
307 – 338

ARNO® – VHM-Gewindefräser / Solid carbide thread milling cutter



Seite / Page
339 – 360

ARNO® – VHM und PM-HSS Gewindebohrer / Solid carbide and PM-HSS taps

(mit und ohne Innenkühlung / with and without internal coolant)



Seite / Page
361 – 391

ARNO® – VHM- und PM-HSS NC-Entgrater / Solid carbide and PM-HSS deburring cutters



Seite / Page
393 – 401

ARNO® – VHM- und PM-HSS-Spiralbohrer / Solid carbide and PM-HSS drills

(mit und ohne Innenkühlung / with and without internal coolant)



Seite / Page
403 – 462

Ausführung / Design **AF** » für **Stahl- und Gusswerkstoffe** / for **steel and cast materials**

Für die allgemeine Fräsbearbeitung von Stahl- und Gusswerkstoffen.
For general milling of steel and cast materials.

Seite / Page
27 - 61

Ausführung / Design **AFJ** » für **rostfreie Stähle und exotische Materialien** / for **stainless steel and exotic materials**

Spezielle Sorte zur Bearbeitung rostfreier Stähle und exotischer Materialien (z. B. Titan, Inconel oder Hastelloy). Geeignet für die HSC-Bearbeitung.
Especially developed for machining stainless steel and exotic materials. Suitable for high speed machining.

Seite / Page
63 - 74

Ausführung / Design **AFA** » für **Aluminium und NE-Metalle** / for **aluminium and non-ferrous materials**

Höchste Performance bei der Bearbeitung von Aluminium und Nichteisenmetallen. Speziell entwickelte Geometrie mit einer höchststabilen Schneidkante garantiert beste Oberflächengüte und ausgezeichnete Spanabfuhr.
Best performance for aluminium and non-ferrous machining. The dedicated geometry with a very strong cutting edge guarantees best surface finish and excellent chip flow.

Seite / Page
75 - 105

Ausführung / Design **AFD** » für **Aluminium, Graphit und NE-Metalle** / for **aluminium, graphite and non-ferrous materials**

Durch die hohe Härte der Beschichtung ergibt sich eine ausgezeichnete Verschleißfestigkeit und sehr hohe Standzeit. Die ultrafeine Diamantbeschichtung überzeugt durch eine optimale Oberflächengüte und hohe Leistungsfähigkeit. Bei der Zerspanung von Graphit und NE-Metallen (Aluminium, Kupfer und Messing/Bronze ect.) sowie bei allen Kunststoffen einsetzbar.
Due to the extreme hardness of the coating these tools offer an excellent wear resistance and very good tool life. The ultra-fine diamond coating impresses with its excellent surface finish and performance it produces. Suitable for machining graphite and non-ferrous metals (aluminium, copper brass and bronze) as well as all plastics.

Seite / Page
107 - 160

Ausführung / Design **AFG** » für **Stähle und gehärtete Stähle** / for **steel and hardened steel (< 50 HRC)**

Geeignet für die Bearbeitung legierter und unlegierter Stähle. Sehr gute Ergebnisse auch bei der Bearbeitung von gehärteten Stählen (bis 50 HRC) sowie zähen Materialien. Ausgezeichnete Ergebnisse bei der Trockenbearbeitung.
For machining of alloy and non-alloy steel. Excellent performance also when machining hard steel up to 50 HRC as well as tough materials. Suitable also for dry-machining.

Seite / Page
161 - 192

Ausführung / Design **AFR** » für **Stahl, Werkzeugstahl, Gusseisen und gehärtete Werkstoffe** / for **steel, tool steel, cast iron and pre-hardened steel (< 40 HRC)**

Schruppfräser mit ungleicher Drallsteigung (43°–46°) für die Bearbeitung von Stahl und legierten Stählen, Werkzeugstählen, Gusseisen und gehärteten Werkstoffen bis 40 HRC.
Roughing cutters with unequal pitch (43°–46°) for machining steel, alloy steel, tool steel, cast materials and hardened steel up to 40 HRC.

Seite / Page
193 - 202

Ausführung / Design **AFH** » für **gehärtete Stähle und HSC-Bearbeitung** / for **hardened steel and high speed milling (<70 HRC)**

Zum Fräsen gehärteter Stähle bis 70 HRC. Fräsen von Gussformen im Werkzeugbau. Auch geeignet für die HSC-Bearbeitung. Trockenbearbeitung möglich.
For milling of hardened steel up to 70 HRC. Also suitable for high speed milling. Can be used for dry milling.

Seite / Page
203 - 243

Ausführung / Design **AFV** » mit **ungleicher Drallsteigung** / with **unequal pitch (35°–38°)**

VHM-Schafffräser mit ungleicher Drallsteigung (35°–38°) für höchste Ansprüche. Geeignet zum Schruppen und Schlichten fast aller Werkstoffe. Vorteile: Bis zu 60% höherer Vorschub – vibrationsfreier Lauf – bessere Oberflächengüte – größere Schnitttiefen.
Solid carbide milling cutter with unequal pitch (35°–38°) for highest requirements. Suitable for roughing and finishing of nearly all materials. Advantages: up to 60% more feed rate, vibration free machining, better surface finish, increased cutting depths.

Seite / Page
245 - 261

Ausführung / Design **AFX** » für **gehärtete Stähle bis 55 HRC, Stahl und Gusseisen** / for **pre-hardened steels up to 55 HRC, steel and cast iron**

VHM-Schafffräser für die Bearbeitung vorgehärteter und naturharter Werkstoffe (bis 55 HRC), Stahl und Gusseisen. Zur Hochgeschwindigkeitsbearbeitung geeignet. Auch Trockenbearbeitung ist möglich.
Solid carbide milling cutters for machining pre-hardened materials up to 55 HRC, steel materials and cast iron. Suitable for high speed milling and also for dry-machining.

Seite / Page
263 - 305

Ausführung / Design **FP** » für **Stahl, rostfreien Stahl und Gusswerkstoffe** /
for **steel, stainless steel and cast materials**

Universalfräser aus pulvermetallurgischem HSS Stahl. TiAIN beschichtet, extrem zäh und verschleißfest, deutlich verbesserte Standzeiten und maximale Schnittleistung.

Universal milling cutters made from powder metal HSS steel. TiAIN coated, extremely tough and wear resistant, improved tool life and maximum cutting performance.

Seite / Page
311 - 327

Ausführung / Design **FS** » für **Stahl, rostfreien Stahl und Gusswerkstoffe** /
for **steel, stainless steel and cast materials**

Universalfräser aus HSS Stahl. Für die Bearbeitung von Stahl, rostfreiem Stahl und Gusswerkstoffen. TiAIN beschichtet, verbesserte Hitze- und Oxidationsbeständigkeit. Zum Trockenfräsen geeignet, sehr temperaturresistent.

Universal milling cutters made from HSS steel. TiAIN coated, improved heat- and oxidation resistance. Suitable for dry machining, very temperature resistant.

Seite / Page
329 - 338

Übersicht **ARNO**-VHM-Gewindefräser

Overview solid carbide thread milling cutter

Ausführung / Design **AFT**

Gewindefräser ISO-Innengewinde

Thread milling cutter ISO-internal thread

Seite / Page
344 - 351

Gewindefräser UNC-Innengewinde

Thread milling cutter UNC-internal thread

Seite / Page
352 - 354

Gewindefräser UNF-Innengewinde

Thread milling cutter UNF-internal thread

Seite / Page
355 - 356

Gewindefräser BSP(G)-Innengewinde

Thread milling cutter BSP(G)-internal thread

Seite / Page
357

Gewindefräser NPT-Innengewinde

Thread milling cutter NPT-internal threadw

Seite / Page
358

Übersicht ARNO® VHM-Maschinengewindebohrer

Overview Solid carbide threat tap

Ausführung / Design **AGT** » gerade genutet, für Durchgangsloch /
straight flute – for through holes

	Seite / Page
Metrisch ISO / ISO metric coarse threads	368
Metrisch ISO – mit Innenkühlung / ISO metric coarse threads – with internal coolant	370
Metrisch ISO – für rostfreie Stähle / ISO metric coarse threads – for stainless steels	372
Metrisch ISO Fein / ISO metric fine threads	374
Metrisch ISO Fein – für rostfreie Stähle / ISO metric fine threads – for stainless steels	376
Amerikanisches Zollgewinde / Unified coarse threads	378
Amerikanisches Zollgewinde Fein / Unified fine threads	380

Ausführung / Design **AGT** » spiralgenutet genutet, für Sackloch /
spiral flute – for through holes

	Seite / Page
Metrisch ISO / ISO metric coarse threads	369
Metrisch ISO – mit Innenkühlung / ISO metric coarse threads – with internal coolant	371
Metrisch ISO – für rostfreie Stähle / ISO metric coarse threads – for stainless steels	373
Metrisch ISO Fein / ISO metric fine threads	375
Metrisch ISO Fein – für rostfreie Stähle / ISO metric fine threads – for stainless steels	377
Amerikanisches Zollgewinde / Unified coarse threads	379
Amerikanisches Zollgewinde Fein / Unified fine threads	381

Übersicht ARNO®-NC-Entgrater

Overview deburring cutter

Ausführung / Design **AE**

TiAlN beschichtete ARNO® Vollhartmetall NC-Entgrater sind optimal geeignet zum Anfasen, Entgraten und für die Konturbearbeitung von Werkstücken nahezu aller gängigen Werkstoffe. Die Schnittgeschwindigkeit liegt bis zu 50% höher als bei unbeschichteten Werkzeugen. Auch mit MMS oder Trockenbearbeitung möglich.

The TiAlN coated ARNO® solid carbide NC-deburring cutter is ideal for chamfering, deburring and contour machining of nearly all conventional materials. The cutting speed is up to 50% higher compared to uncoated tools. The tools can be used with micro lubrication coolant or run dry.

Seite / Page
395 - 401

Übersicht ARNO®-VHM- und PM-HSS-Spiralbohrer

Overview solid carbide drills and powder metal drills

Ausführung / Design **SP**

ARNO® VHM-Bohrer sind durch ihre spezielle Konstruktion und höchste Genauigkeit zum Hochgeschwindigkeitsbohren und für genaue Bohrungen geeignet. Gute Leistung bei Stählen, Grauguss, Werkzeugstählen, Stahllegierungen sowie bei rost- und säurebeständigen Stählen. Schnelle Spanabfuhr und hervorragender Spanbruch durch speziell entwickelte Schneidengeometrien und Spankammern. Hohe Genauigkeit und Stabilität. Höhere Standzeiten durch TiAlN-Beschichtung. Selbstzentrierend.

ARNO® solid carbide drills are suitable for high speed and accurate drilling operations by special design and high quality. Good performance in steels, cast iron, tool steel, alloy steels and stainless steels. Rapid chip evacuation and excellent chip breaking can be achieved by special designed cutting edges on point and chipbreakers on leading edges. High accuracy and stability. Longer tool life by TiAlN coating. Self-centring.

Seite / Page
407 - 462

Übersicht Fräser

Ausführung	Ø	Zähne z	R	bohr- fähig	P	M	K	N	S	H [HRC]	Spiral- winkel	Beschich- tung	Seite
VHM-Schaftfräser													
AF													
AF50526 Mini	0,4 - 4,0	2		✓	●		●				30°	TiAIN	28
AF52021 Mini	0,4 - 4,0	2		✓	●		●				30°	TiAIN	30
AF60125 kurz	2,0 - 20,0	2		✓	●	●	●				30°	TiAIN	31
AF50120 -R kurz	2,0 - 12,0	2	✓	✓	●	●	●				30°	TiAIN	32
AF50121 lang	2,0	2		✓	●	●	●				30°	TiAIN	33
AF60121 lang	2,8 - 20,0	2		✓	●	●	●				30°	TiAIN	33
AF50121 -R lang	3,0 - 12,0	2	✓	✓	●	●	●				30°	TiAIN	34
AF50122 extra lang	3,0 - 20,0	2		✓	●	●	●				30°	TiAIN	35
AF60320 kurz	2,0 - 20,0	2		✓	●		●				30°	TiAIN	36
AF50321 lang	3,0 - 20,0	2		✓	●		●				30°	TiAIN	37
AF60321 lang	3,0 - 20,0	2		✓	●		●				30°	TiAIN	38
AF50322 extra lang	3,0 - 20,0	2		✓	●		●				30°	TiAIN	39
AF50135 extra kurz	0,5 - 1,8	3		✓	●	●	●				30°	TiAIN	40
AF60135 extra kurz	2,0 - 20,0	3		✓	●	●	●				30°	TiAIN	40
AF61330 kurz	2,0 - 20,0	3		✓	●	●	●				30°	TiAIN	41
AF60131 lang	3,0 - 20,0	3		✓	●	●	●				30°	TiAIN	42
AF60231 lang	3,0 - 20,0	3		✓	●	●	●				45°	TiAIN	43
AF50140 kurz	1,0 - 20,0	4		✓	●	●	●				30°	TiAIN	44
AF50140 -R kurz	2,0 - 12,0	4	✓	✓	●	●	●				30°	TiAIN	45
AF60140 kurz	2,0 - 20,0	4		✓	●	●	●				30°	TiAIN	46
AF50141 lang	2,0	4		✓	●	●	●				30°	TiAIN	47
AF60141 lang	3,0 - 20,0	4		✓	●	●	●				30°	TiAIN	47
AF50141 -R lang	3,0 - 12,0	4	✓	✓	●	●	●				30°	TiAIN	48
AF50142 extra lang	3,0 - 20,0	4		✓	●	●	●				30°	TiAIN	49
AF60142 extra lang	6,0 - 10,0	4		✓	●	●	●				30°	TiAIN	49
AF50340 kurz	2,0 - 20,0	4		✓	●		●		○		30°	TiAIN	50
AF502.0 kurz	3,0 - 20,0	4 - 6		✓	●	●	●				45°	TiAIN	51
AF50261 lang	12,0 - 20,0	6		✓	●	●	●				45°	TiAIN	52
AF614.1 lang	6,0 - 25,0	3 - 5		✓	●	●			○		30°	TiAIN	53
AFJ													
AFJ612.1 lang	3,0 - 25,0	3 - 4		✓	○	●			●		50°	TiAIN	64
AFJ602.0 lang	3,0 - 20,0	4 - 8			○	●			●		45°	TiAIN	65
AFJ619.1 lang	4,0 - 25,0	3 - 6			○	●			●		45°	TiAIN	66
AFA													
AFA50116 mittellang	2,0 - 12,0	1		✓				●			30°	TiCN	76
AFA50220 kurz	3,0 - 20,0	2		✓				●			45°	TiCN	77
AFA51820 kurz	6,0 - 20,0	2		✓				●			50°	TiCN	78
AFA51521 lang	3,0 - 20,0	2		✓				●			45°	uncoated	79
AFA50720 -R lang	4,0 - 20,0	2	✓	✓				●			30°	TiCN	80
AFA51522 extra lang	1,0 - 20,0	2		✓				●			45°	TiCN	81
AFA50222 extra lang	1,0 - 20,0	2		✓				●			45°	TiCN	82
AFA51836 mittellang	6,0 - 20,0	3		✓				●			45°	TiCN	83
AFA52336 mittellang	3,0 - 20,0	3		✓				●			45°	TiCN	84
AFA52330 lang	3,5 - 20,0	3		✓				●			30°	uncoated	85
AFA51531 lang	3,0 - 20,0	3		✓				●			45°	TiCN	86
AFA50231 -R lang	3,0 - 20,0	3	✓	✓				●			45°	TiCN	87
AFA51532 extra lang	3,0 - 20,0	3		✓				●			45°	TiCN	88
AFA50232 extra lang	1,0 - 20,0	3		✓				●			45°	TiCN	89
AFA51831 kurz	2,0 - 20,0	3		✓				●			40°	TiCN	92
AFA61431 lang	6,0 - 25,0	3		✓				●			30°	uncoated	93
AFA51431 lang	6,0 - 25,0	3		✓				●			30°	TiCN	94
AFA52131 lang	4,0 - 20,0	3		✓				●			42°	TiCN	95
AFA51931 lang	4,0 - 20,0	3		✓				●			45°	TiCN	96
AFA52331 lang	4,0 - 20,0	3		✓				●			45°	TiCN	97

● = Hauptanwendung
○ = Nebenanwendung

Übersicht Fräser

Ausführung	∅	Zähne z	R	bohr- fähig	P	M	K	N	S	H [HRC]	Spiral- winkel	Beschich- tung	Seite
AFD													
AFD50724 -R Mini	0,2 - 6,0	2	✓	✓	●						30°	Diamant	108
AFD50727 -R	1,0 - 2,0	2	✓	✓	●						30°	Diamant	109
AFD50121 lang	0,5 - 12,0	2		✓	●						30°	Diamant	110
AFD51520 short	1,0 - 20,0	2		✓	●						45°	Diamant	111
AFD51824 Mini	0,2 - 6,0	2		✓	●						30°	Diamant	112
AFD50325 Mini	0,4 - 4,0	2		✓	●						30°	Diamant	113
AFD51826	1,0 - 2,0	2		✓	●						30°	Diamant	114
AFD51821 lang	2,0 - 12,0	2		✓	●						30°	Diamant	115
AFD51823 überlang	2,0 - 12,0	2		✓	●						30°	Diamant	116
AFD51820 kurz	2,0 - 12,0	2		✓	●						30°	Diamant	117
AFD54030 -R kurz	2,0 - 12,0	3	✓	✓	●						40°	Diamant	118
AFD54031 -R lang	2,0 - 12,0	3	✓	✓	●						40°	Diamant	119
AFD51830 kurz	2,0 - 12,0	3		✓	●						30°	Diamant	120
AFD50740 -R	6,0 - 12,0	4	✓	✓	●						30°	Diamant	121
AFG													
AFG50120 kurz	2,0 - 25,0	2		✓	●	●				<50	30°	TiAlN	162
AFG50121 lang	2,0 - 25,0	2		✓	●	●				<50	30°	TiAlN	163
AFG50321 lang	2,0 - 25,0	2		✓	●					<50	30°	TiAlN	164
AFG50322	1,0 - 12,0	2			●					<50	30°	TiAlN	165
AFG52021 lang	0,4 - 6,0	2			●					<50	30°	TiAlN	166
AFG51621 lang	3,0 - 12,0	2			●					<50	30°	TiAlN	168
AFG50134 Mini	1,5 - 12,0	3			●	●				<50	30°	TiAlN	169
AFG60134 Mini	1,5 - 12,0	3			●	●				<50	30°	TiAlN	169
AFG50745 -R	2,0 - 16,0	4	✓		●	●				<50	30°	TiAlN	170
AFG50140 kurz	2,0 - 25,0	4			●	●				<50	30°	TiAlN	171
AFG60140 kurz	2,0 - 20,0	4			●	●				<50	30°	TiAlN	172
AFG50741 -R lang	3,0 - 20,0	4	✓		●	●				<50	30°	TiAlN	173
AFG50141 lang	2,0 - 25,0	4			●					<50	30°	TiAlN	174
AFG60141 lang	3,0 - 25,0	4			●					<50	30°	TiAlN	175
AFG502.0 lang	4,0 - 25,0	4 - 8			●					<50	45°	TiAlN	176
AFG602.0 lang	4,0 - 25,0	4 - 8			●					<50	45°	TiAlN	177
AFG50861 -R lang	6,0 - 20,0	6	✓	✓	●					<50	45°	TiAlN	178
AFG50262 extra lang	6,0 - 25,0	6			●					<50	45°	TiAlN	179
AFG60262 extra lang	6,0 - 25,0	6			●					<50	45°	TiAlN	180
AFG606.0 kurz	6,0 - 25,0	3 - 5			●					<50	20°	TiAlN	181
AFG606.1 lang	6,0 - 25,0	3 - 5			●					<50	20°	TiAlN	182
AFR													
AFR619.0 kurz	6,0 - 20,0	4 - 5	✓	✓	●	●	●			<40	43 - 46°	AlCrN	194
AFR619.1 extra lang	6,0 - 20,0	4 - 5	✓	✓	●	●	●			<40	43 - 46°	AlCrN	195
AFR619.2 lang	6,0 - 20,0	4 - 5	✓	✓	●	●	●			<40	43 - 46°	AlCrN	196
AFR619.3 lang	6,0 - 20,0	4 - 5			●	●	●			<40	43 - 46°	TiAlN	197
AFH													
AFH50120 -R Mini	0,3 - 2,0	2	✓	✓	●					●	30°	TiA70	204
AFH50526 Mini	0,1 - 4,0	2		✓	●					●	30°	TiA70	205
AFH50920 -R Mini	0,5 - 2,0	2	✓	✓	●					●	30°	TiA70	207
AFH50320 Mini	0,4 - 2,0	2		✓	●					●	30°	TiA70	208
AFH52020 Mini	0,5 - 2,0	2		✓	●					●	30°	TiA70	209
AFH52021 Mini	0,1 - 4,0	2		✓	●					●	30°	TiA70	210
AFH50125	0,1 - 20,0	2		✓	●					●	30°	TiA70	212
AFH50725 -R	0,5 - 20,0	2	✓	✓	●					●	30°	TiA70	213
AFH50926 -R	0,5 - 12,0	2	✓	✓	●					●	30°	TiA70	214
AFH51625	1,0 - 25,0	2		✓	●					●	30°	TiA70	216
AFH51626	0,1 - 12,0	2		✓	●					●	30°	TiA70	217
AFH51635	3,0 - 20,0	3		✓	●					●	30°	TiA70	218
AFH50140	1,0 - 20,0	4			●					●	30°	TiA70	219

● = Hauptanwendung
○ = Nebenanwendung

Alle Angaben in mm

Übersicht Fräser

Ausführung	∅	Zähne z	R	bohr- fähig	P	M	K	N	S	H [HRC]	Spiral- winkel	Beschich- tung	Seite
AFH50142 -R	6,0 - 12,0	4	✓		●					●	30°	TiA70	220
AFH50146 -R	3,0 - 12,0	4	✓		●					●	30°	TiA70	221
AFH50745 -R	1,0 - 20,0	4	✓		●					●	30°	TiA70	222
AFH50341	3,0 - 20,0	4		✓	●					●	30°	TiA70	223
AFH50865 -R	6,0 - 20,0	6	✓		●					●	45°	TiA70	224
AFH508.1 long	6,0 - 25,0	6 - 8		✓	●					●	45°	TiA70	225
AFH508.2 extra lang	6,0 - 25,0	6 - 8		✓	●					●	45°	TiA70	226
AFH50746 -R kurz	2,0 - 12,0	4	✓		●					●	90°	TiA70	227
AFH50741 -R lang	2,0 - 16,0	4	✓		●					●	90°	TiA70	228
AFV													
AFV61840 -R kurz	3,0 - 20,0	4	✓		○	●	○		○		35 - 38°	TiAIN	246
AFV61840 -R kurz	3,0 - 20,0	4	✓		●	●	●		●		35 - 38°	S100	247
AFV62342 kurz	3,0 - 20,0	4			●	●	●		●		35 - 38°	S100	248
AFV62342 -R kurz	3,0 - 20,0	4	✓		●	●	●		●		35 - 38°	S100	249
AFV61841 -R lang	3,0 - 25,0	4	✓		○	●	○		○		35 - 38°	TiAIN	250
AFV61841 -R lang	3,0 - 25,0	4	✓		●	●	●		●		35 - 38°	S100	251
AFV60341 lang	3,0 - 25,0	4			○	●	○		○		35 - 38°	TiAIN	252
AFV61851 lang	6,0 - 25,0	5			○	●	○		○		35 - 38°	TiAIN	253
AFX													
AFX50124 -R Mini	0,2 - 20,0	2	✓		●		●			●	30°	S100	264
AFX50120 kurz	0,1 - 20,0	2			●		●			●	30°	S100	268
AFX50121 lang	1,0 - 20,0	2			●		●			●	30°	S100	269
AFX50121 -R lang	1,0 - 20,0	2	✓		●		●			●	30°	S100	271
AFX50122 extra lang	0,2 - 12,0	2			●		●			●	30°	S100	273
AFX50321 lang	0,1 - 20,0	2			●		●			●	30°	S100	275
AFX52021 lang	0,2 - 12,0	2			●		●			●	30°	S100	277
AFX50140 kurz	1,0 - 25,0	4		✓	●		●			●	26 - 30°	S100	279
AFX50041 -R lang	1,0 - 20,0	4	✓	✓	●		●			●	30 - 38°	S100	280
AFX50741 -R lang	1,0 - 20,0	4	✓	✓	●		●			●	30°	S100	283
AFX50042 extra lang	1,0 - 20,0	4		✓	●		●			●	35 - 38°	S100	285
AFX50141 lang	1,0 - 25,0	4		✓	●		●			●	30°	S100	286
AFX50142 extra lang	1,0 - 12,0	4		✓	●		●			●	30°	S100	288
AFX50260 kurz	6,0 - 20,0	6		✓	●		●			●	45°	S100	289
PM-HSS-Schaftfräser													
FP													
FP60120 kurz	2,0 - 25,0	2		✓	●	●	●		○	<40	30°	TiAIN	312
FP60121 lang	2,0 - 25,0	2		✓	●	●	●		○	<40	30°	TiAIN	313
FP60320 kurz	2,0 - 25,0	2		✓	●	●	●		○	<40	30°	TiAIN	314
FP60321 lang	2,0 - 25,0	2		✓	●	●	●		○	<40	30°	TiAIN	315
FP60135 extra kurz	3,0 - 25,0	2		✓	●	●	●		○	<40	30°	TiAIN	316
FP60130 kurz	2,0 - 25,0	3		✓	●	●	●		○	<40	30°	TiAIN	317
FP601.0 kurz	2,0 - 25,0	3		✓	●	●	●		○	<40	30°	TiAIN	318
FP601.1 lang	2,0 - 32,0	4 - 6		✓	●	●	●		○	<40	30°	TiAIN	319
FP618.0 kurz	2,0 - 32,0	4 - 6		✓	●	●	●		○	<40	30°	TiAIN	320
FP618.6 mittellang	6,0 - 32,0	3 - 6		< ∅ 20	●	●	●		○	<40	30°	TiAIN	321
FP618.1 lang	6,0 - 32,0	3 - 6		< ∅ 20	●	●	●		○	<40	30°	TiAIN	322
FP619.5 extra kurz	6,0 - 25,0	3 - 6		< ∅ 20	●	●	●		○	<40	30°	TiAIN	323
FP619.0 kurz	4,0 - 25,0	4 - 6		< ∅ 20	●	●	●		○	<40	45°	TiAIN	324
FP620.0 kurz	6,0 - 32,0	3 - 6		< ∅ 20	●	●	●		○	<40	45°	TiAIN	325
FP620.1 lang	6,0 - 32,0	3 - 6		< ∅ 20	●	●	●		○	<40	30°	TiAIN	326
FP623.1 extra lang	6,0 - 32,0	3 - 6		< ∅ 20	●	●	●		○	<40	30°	TiAIN	327
FS													
FS60120 kurz	1,0 - 20,0	2		✓	●	●	●		○	<40	30°	TiAIN	330
FS60320 kurz	2,0 - 20,0	2		✓	●	●	●		○	<40	30°	TiAIN	331
FS60140 kurz	2,0 - 20,0	4		✓	●	●	●		○	<40	30°	TiAIN	332
FS618.0 kurz	6,0 - 20,0	3 - 4			●	●	●		○	<40	30°	TiAIN	333
FS620.0 kurz	6,0 - 20,0	3 - 4		✓	●	●	●		○	<40	30°	TiAIN	334

● = Hauptanwendung
○ = Nebenanwendung

Alle Angaben in mm

Schneidenzahl / Number of flutes

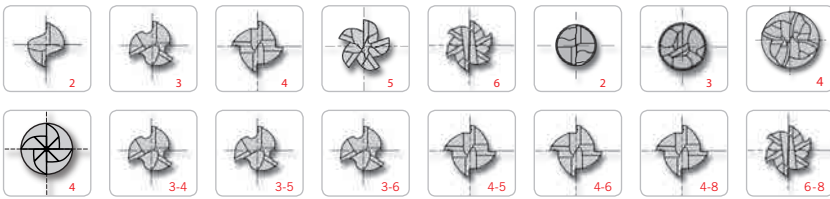

Innenkühlung / Through tool coolant



Spiralwinkel / Helix angle



Schaftform / Shank

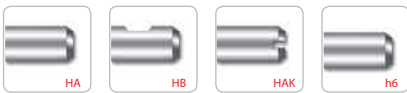

Winkel / Angle

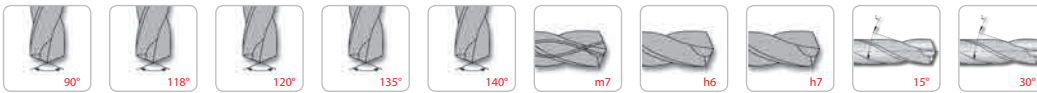

Verzahnung / Pitch



Mögliche Vorschubrichtung / Possible feed direction

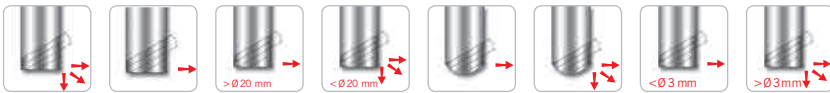

Werkstoff / Material



Beschichtung / Coating



Eckenradius / Corner radius

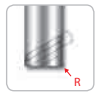

Gewinde / Thread

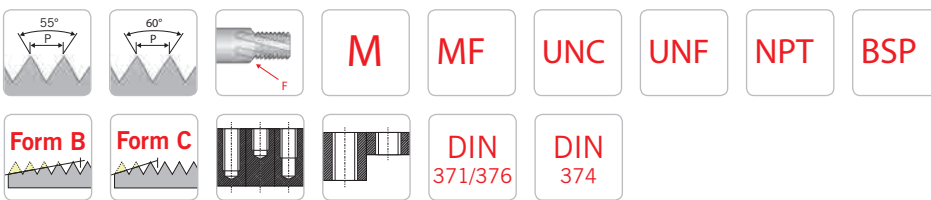

Toleranz / Tolerance

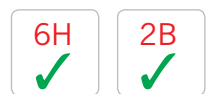

Ø-Bereich / Diameter range



Entgrater Winkel / deburring cutter angle



Schneidstoff / Cutting material



Anwendung / Application



Schneidstoff / Cutting material



Sonstige / Other



Overview Milling

Version	∅	Teeth z	R	Center cutting	P	M	K	N	S	H [HRC]	Helix- angle	Coating	Page
Solid carbide milling cutters													
AF													
AF50526 Mini	0,4 - 4,0	2		✓	●		●				30°	TiAlN	28
AF52021 Mini	0,4 - 4,0	2		✓	●		●				30°	TiAlN	30
AF60125 short	2,0 - 20,0	2		✓	●	●	●				30°	TiAlN	31
AF50120 -R short	2,0 - 12,0	2	✓	✓	●	●	●				30°	TiAlN	32
AF50121 long	2,0	2		✓	●	●	●				30°	TiAlN	33
AF60121 long	2,8 - 20,0	2		✓	●	●	●				30°	TiAlN	33
AF50121 -R long	3,0 - 12,0	2	✓	✓	●	●	●				30°	TiAlN	34
AF50122 extra long	3,0 - 20,0	2		✓	●	●	●				30°	TiAlN	35
AF60320 short	2,0 - 20,0	2		✓	●		●				30°	TiAlN	36
AF50321 long	3,0 - 20,0	2		✓	●		●				30°	TiAlN	37
AF60321 long	3,0 - 20,0	2		✓	●		●				30°	TiAlN	38
AF50322 extra long	3,0 - 20,0	2		✓	●		●				30°	TiAlN	39
AF50135 extra short	0,5 - 1,8	3		✓	●	●	●				30°	TiAlN	40
AF60135 extra short	2,0 - 20,0	3		✓	●	●	●				30°	TiAlN	40
AF61330 short	2,0 - 20,0	3		✓	●	●	●				30°	TiAlN	41
AF60131 long	3,0 - 20,0	3		✓	●	●	●				30°	TiAlN	42
AF60231 long	3,0 - 20,0	3		✓	●	●	●				45°	TiAlN	43
AF50140 short	1,0 - 20,0	4		✓	●	●	●				30°	TiAlN	44
AF50140 -R short	2,0 - 12,0	4	✓	✓	●	●	●				30°	TiAlN	45
AF60140 short	2,0 - 20,0	4		✓	●	●	●				30°	TiAlN	46
AF50141 long	2,0	4		✓	●	●	●				30°	TiAlN	47
AF60141 long	3,0 - 20,0	4		✓	●	●	●				30°	TiAlN	47
AF50141 -R long	3,0 - 12,0	4	✓	✓	●	●	●				30°	TiAlN	48
AF50142 extra long	3,0 - 20,0	4		✓	●	●	●				30°	TiAlN	49
AF60142 extra long	6,0 - 10,0	4		✓	●	●	●				30°	TiAlN	49
AF50340 short	2,0 - 20,0	4		✓	●		●		○		30°	TiAlN	50
AF502.0 short	3,0 - 20,0	4 - 6		✓	●	●	●				45°	TiAlN	51
AF50261 long	12,0 - 20,0	6		✓	●	●	●				45°	TiAlN	52
AF614.1 long	6,0 - 25,0	3 - 5		✓	●	●			○		30°	TiAlN	53
AFJ													
AFJ612.1 long	3,0 - 25,0	3 - 4		✓	○	●			●		50°	TiAlN	64
AFJ602.0 long	3,0 - 20,0	4 - 8			○	●			●		45°	TiAlN	65
AFJ619.1 long	4,0 - 25,0	3 - 6			○	●			●		45°	TiAlN	66
AFA													
AFA50116 mid-length	2,0 - 12,0	1		✓				●			30°	TiCN	76
AFA50220 short	3,0 - 20,0	2		✓				●			45°	TiCN	77
AFA51820 short	6,0 - 20,0	2		✓				●			50°	TiCN	78
AFA51521 long	3,0 - 20,0	2		✓				●			45°	uncoated	79
AFA50720 -R long	4,0 - 20,0	2	✓	✓				●			30°	TiCN	80
AFA51522 extra long	1,0 - 20,0	2		✓				●			45°	TiCN	81
AFA50222 extra long	1,0 - 20,0	2		✓				●			45°	TiCN	82
AFA51836 mid-length	6,0 - 20,0	3		✓				●			45°	TiCN	83
AFA52336 mid-length	3,0 - 20,0	3		✓				●			45°	TiCN	84
AFA52330 long	3,5 - 20,0	3		✓				●			30°	uncoated	85
AFA51531 long	3,0 - 20,0	3		✓				●			45°	TiCN	86
AFA50231 -R long	3,0 - 20,0	3	✓	✓				●			45°	TiCN	87
AFA51532 extra long	3,0 - 20,0	3		✓				●			45°	TiCN	88
AFA50232 extra long	1,0 - 20,0	3		✓				●			45°	TiCN	89
AFA51831 short	2,0 - 20,0	3		✓				●			40°	TiCN	92
AFA61431 long	6,0 - 25,0	3		✓				●			30°	uncoated	93
AFA51431 long	6,0 - 25,0	3		✓				●			30°	TiCN	94
AFA52131 long	4,0 - 20,0	3		✓				●			42°	TiCN	95
AFA51931 long	4,0 - 20,0	3		✓				●			45°	TiCN	96
AFA52331 long	4,0 - 20,0	3		✓				●			45°	TiCN	97

● = Main application
○ = Suitable

Overview Milling

Version	∅	Teeth z	R	Center cutting	P	M	K	N	S	H [HRC]	Helix- angle	Coating	Page
AFD													
AFD50724 -R Mini	0,2 - 6,0	2	✓	✓	●	●	●	●	●	●	30°	Diamant	108
AFD50727 -R	1,0 - 2,0	2	✓	✓	●	●	●	●	●	●	30°	Diamant	109
AFD50121 long	0,5 - 12,0	2		✓	●	●	●	●	●	●	30°	Diamant	110
AFD51520 short	1,0 - 20,0	2		✓	●	●	●	●	●	●	45°	Diamant	111
AFD51824 Mini	0,2 - 6,0	2		✓	●	●	●	●	●	●	30°	Diamant	112
AFD50325 Mini	0,4 - 4,0	2		✓	●	●	●	●	●	●	30°	Diamant	113
AFD51826	1,0 - 2,0	2		✓	●	●	●	●	●	●	30°	Diamant	114
AFD51821 long	2,0 - 12,0	2		✓	●	●	●	●	●	●	30°	Diamant	115
AFD51823 extra long	2,0 - 12,0	2		✓	●	●	●	●	●	●	30°	Diamant	116
AFD51820 short	2,0 - 12,0	2		✓	●	●	●	●	●	●	30°	Diamant	117
AFD54030 -R short	2,0 - 12,0	3	✓	✓	●	●	●	●	●	●	40°	Diamant	118
AFD54031 -R long	2,0 - 12,0	3	✓	✓	●	●	●	●	●	●	40°	Diamant	119
AFD51830 short	2,0 - 12,0	3		✓	●	●	●	●	●	●	30°	Diamant	120
AFD50740 -R	6,0 - 12,0	4	✓	✓	●	●	●	●	●	●	30°	Diamant	121
AFG													
AFG50120 short	2,0 - 25,0	2		✓	●	●	●	●	●	<50	30°	TiAlN	162
AFG50121 long	2,0 - 25,0	2		✓	●	●	●	●	●	<50	30°	TiAlN	163
AFG50321 long	2,0 - 25,0	2		✓	●	●	●	●	●	<50	30°	TiAlN	164
AFG50322	1,0 - 12,0	2			●	●	●	●	●	<50	30°	TiAlN	165
AFG52021 long	0,4 - 6,0	2			●	●	●	●	●	<50	30°	TiAlN	166
AFG51621 long	3,0 - 12,0	2			●	●	●	●	●	<50	30°	TiAlN	168
AFG50134 Mini	1,5 - 12,0	3			●	●	●	●	●	<50	30°	TiAlN	169
AFG60134 Mini	1,5 - 12,0	3			●	●	●	●	●	<50	30°	TiAlN	169
AFG50745 -R	2,0 - 16,0	4	✓		●	●	●	●	●	<50	30°	TiAlN	170
AFG50140 short	2,0 - 25,0	4			●	●	●	●	●	<50	30°	TiAlN	171
AFG60140 short	2,0 - 20,0	4			●	●	●	●	●	<50	30°	TiAlN	172
AFG50741 -R long	3,0 - 20,0	4	✓		●	●	●	●	●	<50	30°	TiAlN	173
AFG50141 long	2,0 - 25,0	4			●	●	●	●	●	<50	30°	TiAlN	174
AFG60141 long	3,0 - 25,0	4			●	●	●	●	●	<50	30°	TiAlN	175
AFG502.0 long	4,0 - 25,0	4 - 8			●	●	●	●	●	<50	45°	TiAlN	176
AFG602.0 long	4,0 - 25,0	4 - 8			●	●	●	●	●	<50	45°	TiAlN	177
AFG50861 -R long	6,0 - 20,0	6	✓	✓	●	●	●	●	●	<50	45°	TiAlN	178
AFG50262 extra long	6,0 - 25,0	6			●	●	●	●	●	<50	45°	TiAlN	179
AFG60262 extra lang	6,0 - 25,0	6			●	●	●	●	●	<50	45°	TiAlN	180
AFG606.0 short	6,0 - 25,0	3 - 5			●	●	●	●	●	<50	20°	TiAlN	181
AFG606.1 long	6,0 - 25,0	3 - 5			●	●	●	●	●	<50	20°	TiAlN	182
AFR													
AFR619.0 short	6,0 - 20,0	4 - 5	✓	✓	●	●	●	●	●	<40	43 - 46°	AlCrN	194
AFR619.1 extra long	6,0 - 20,0	4 - 5	✓	✓	●	●	●	●	●	<40	43 - 46°	AlCrN	195
AFR619.2 long	6,0 - 20,0	4 - 5	✓	✓	●	●	●	●	●	<40	43 - 46°	AlCrN	196
AFR619.3 long	6,0 - 20,0	4 - 5			●	●	●	●	●	<40	43 - 46°	TiAlN	197
AFH													
AFH50120 -R Mini	0,3 - 2,0	2	✓	✓	●	●	●	●	●	●	30°	TiA70	204
AFH50526 Mini	0,1 - 4,0	2		✓	●	●	●	●	●	●	30°	TiA70	205
AFH50920 -R Mini	0,5 - 2,0	2	✓	✓	●	●	●	●	●	●	30°	TiA70	207
AFH50320 Mini	0,4 - 2,0	2		✓	●	●	●	●	●	●	30°	TiA70	208
AFH52020 Mini	0,5 - 2,0	2		✓	●	●	●	●	●	●	30°	TiA70	209
AFH52021 Mini	0,1 - 4,0	2		✓	●	●	●	●	●	●	30°	TiA70	210
AFH50125	0,1 - 20,0	2		✓	●	●	●	●	●	●	30°	TiA70	212
AFH50725 -R	0,5 - 20,0	2	✓	✓	●	●	●	●	●	●	30°	TiA70	213
AFH50926 -R	0,5 - 12,0	2	✓	✓	●	●	●	●	●	●	30°	TiA70	214
AFH51625	1,0 - 25,0	2		✓	●	●	●	●	●	●	30°	TiA70	216
AFH51626	0,1 - 12,0	2		✓	●	●	●	●	●	●	30°	TiA70	217
AFH51635	3,0 - 20,0	3		✓	●	●	●	●	●	●	30°	TiA70	218
AFH50140	1,0 - 20,0	4			●	●	●	●	●	●	30°	TiA70	219

● = Main application
○ = Suitable

Dimensions in mm

Overview Milling

Version	∅	Teeth z	R	Center cutting	P	M	K	N	S	H [HRC]	Helix- angle	Coating	Page
AFH50142 -R	6,0 - 12,0	4	✓		●					●	30°	TiA70	220
AFH50146 -R	3,0 - 12,0	4	✓		●					●	30°	TiA70	221
AFH50745 -R	1,0 - 20,0	4	✓		●					●	30°	TiA70	222
AFH50341	3,0 - 20,0	4		✓	●					●	30°	TiA70	223
AFH50865 -R	6,0 - 20,0	6	✓		●					●	45°	TiA70	224
AFH508.1 long	6,0 -25,0	6 - 8		✓	●					●	45°	TiA70	225
AFH508.2 extra long	6,0 - 25,0	6 - 8		✓	●					●	45°	TiA70	226
AFH50746 -R short	2,0 - 12,0	4	✓		●					●	90°	TiA70	227
AFH50741 -R long	2,0 - 16,0	4	✓		●					●	90°	TiA70	228
AFV													
AFV61840 -R short	3,0 - 20,0	4	✓		○	●	○		○		35 - 38°	TiAlN	246
AFV61840 -R short	3,0 - 20,0	4	✓		●	●	●		●		35 - 38°	S100	247
AFV62342 short	3,0 - 20,0	4			●	●	●		●		35 - 38°	S100	248
AFV62342 -R short	3,0 - 20,0	4	✓		●	●	●		●		35 - 38°	S100	249
AFV61841 -R long	3,0 - 25,0	4	✓		○	●	○		○		35 - 38°	TiAlN	250
AFV61841 -R long	3,0 - 25,0	4	✓		●	●	●		●		35 - 38°	S100	251
AFV60341 long	3,0 - 25,0	4			○	●	○		○		35 - 38°	TiAlN	252
AFV61851 long	6,0 - 25,0	5			○	●	○		○		35 - 38°	TiAlN	253
AFX													
AFX50124 -R Mini	0,2 - 20,0	2	✓		●		●			●	30°	S100	264
AFX50120 short	0,1 - 20,0	2			●		●			●	30°	S100	268
AFX50121 long	1,0 - 20,0	2			●		●			●	30°	S100	269
AFX50121 -R long	1,0 - 20,0	2	✓		●		●			●	30°	S100	271
AFX50122 extra long	0,2 - 12,0	2			●		●			●	30°	S100	273
AFX50321 long	0,1 - 20,0	2			●		●			●	30°	S100	275
AFX52021 long	0,2 - 12,0	2			●		●			●	30°	S100	277
AFX50140 short	1,0 - 25,0	4		✓	●		●			●	26 - 30°	S100	279
AFX50041 -R long	1,0 - 20,0	4	✓	✓	●		●			●	30 - 38°	S100	280
AFX50741 -R long	1,0 - 20,0	4	✓	✓	●		●			●	30°	S100	283
AFX50042 extra long	1,0 - 20,0	4		✓	●		●			●	35 - 38°	S100	285
AFX50141 long	1,0 - 25,0	4		✓	●		●			●	30°	S100	286
AFX50142 extra long	1,0 - 12,0	4		✓	●		●			●	30°	S100	288
AFX50260 short	6,0 - 20,0	6		✓	●		●			●	45°	S100	289
Powder metal milling cutters													
FP													
FP60120 short	2,0 - 25,0	2		✓	●	●	●		○	<40	30°	TiAlN	312
FP60120 short	2,0 - 25,0	2		✓	●	●	●		○	<40	30°	TiAlN	313
FP60121 long	2,0 - 25,0	2		✓	●	●	●		○	<40	30°	TiAlN	314
FP60320 short	2,0 - 25,0	2		✓	●	●	●		○	<40	30°	TiAlN	315
FP60321 long	3,0 - 25,0	2		✓	●	●	●		○	<40	30°	TiAlN	316
FP60135 extra short	2,0 - 25,0	3		✓	●	●	●		○	<40	30°	TiAlN	317
FP60130 short	2,0 - 25,0	3		✓	●	●	●		○	<40	30°	TiAlN	318
FP601.0 short	2,0 - 32,0	4 - 6		✓	●	●	●		○	<40	30°	TiAlN	319
FP601.1 long	2,0 - 32,0	4 - 6		✓	●	●	●		○	<40	30°	TiAlN	320
FP618.0 short	6,0 - 32,0	3 - 6		< ∅ 20	●	●	●		○	<40	30°	TiAlN	321
FP618.6 mid-length	6,0 - 32,0	3 - 6		< ∅ 20	●	●	●		○	<40	30°	TiAlN	322
FP618.1 long	6,0 - 25,0	3 - 6		< ∅ 20	●	●	●		○	<40	30°	TiAlN	323
FP619.5 extra short	4,0 - 25,0	4 - 6		< ∅ 20	●	●	●		○	<40	45°	TiAlN	324
FP619.0 short	6,0 - 32,0	3 - 6		< ∅ 20	●	●	●		○	<40	45°	TiAlN	325
FP620.0 short	6,0 - 32,0	3 - 6		< ∅ 20	●	●	●		○	<40	30°	TiAlN	326
FP620.1 long	6,0 - 32,0	3 - 6		< ∅ 20	●	●	●		○	<40	30°	TiAlN	327
FS													
FS60120 short	1,0 - 20,0	2		✓	●	●	●		○	<40	30°	TiAlN	330
FS60320 short	2,0 - 20,0	2		✓	●	●	●		○	<40	30°	TiAlN	331
FS60140 short	2,0 - 20,0	4		✓	●	●	●		○	<40	30°	TiAlN	332
FS618.0 short	6,0 - 20,0	3 - 4			●	●	●		○	<40	30°	TiAlN	333
FS620.0 short	6,0 - 20,0	3 - 4		✓	●	●	●		○	<40	30°	TiAlN	334

● = Main application
○ = Suitable

ARNO®

WERKZEUGE

We have a passion for precision.

VOLLHARTMETALL-SCHAFTFRÄSER

Solid carbide end-mills











Ausführung











- AF** - für Stahl und Gusswerkstoffe
- AFJ** - für rostfreie Stähle und exotische Werkstoffe
- AFA** - für Aluminium und NE-Metalle
- AFD** - für Aluminium, Graphit und NE-Metalle
- AFG** - für Stahl und gehärtete Stähle bis 50 HRC
- AFR** - für Stahl, Werkzeugstahl, Gusseisen und gehärtete Werkstoffe
- AFH** - für gehärtete Stähle bis 70 HRC und HSC-Bearbeitung
- AFV** - mit ungleicher Drallsteigung (35°–38°)
- AFX** - für gehärtete Stähle bis 55 HRC, Stahl und Gusseisen

Design











- AF** - for steel and cast materials
- AFJ** - for stainless steel and exotic materials
- AFA** - for aluminium and non-ferrous machining
- AFD** - for aluminium, graphite and non-ferrous materials
- AFG** - for steel and hardened steel up to 50 HRC
- AFR** - for steel, tool steel, cast iron and pre-hardened steel to 40 HRC
- AFH** - for hardened steel up to 70 HRC and high speed milling
- AFV** - with unequal pitch (26°–30°/35°–38°)
- AFX** - for pre-hardened steels up to 55 HRC, steel and cast iron



Bezeichnung Description	Schneiden Flutes	Fräser typ Type	Ausführung Design	Spiralwinkel Helix angle	Abb. Picture	Seite Page
AF - für Stahl und Gusswerkstoffe / for steel and cast materials						
AF50526-...	2	Schaftfräser end-mill	mini	30°		28
AF52021-...	2	Radiusfräser Ball-nose end-mill	mini	30°		30
AF60125-...	2	Schaftfräser end-mill	kurz short	30°		31
AF50120-...R...	2	Schaftfräser end-mill	kurz, mit Eckenradius short, with corner radius	30°		32
AF50121-... / AF60121-...	2	Schaftfräser end-mill	lang long	30°		33
AF50121-...R...	2	Schaftfräser end-mill	lang, mit Eckenradius long, with corner radius	30°		34
AF50122-...	2	Schaftfräser end-mill	extra lang extra long	30°		35
AF60320-...	2	Radiusfräser Ball-nose end-mill	kurz short	30°		36
AF50321-...	2	Radiusfräser Ball-nose end-mill	lang long	30°		37
AF60321-...	2	Radiusfräser Ball-nose end-mill	lang long	30°		38
AF50322-...	2	Radiusfräser Ball-nose end-mill	extra lang extra long	30°		39

Bezeichnung Description	Schneiden Flutes	Fräser Type	Ausführung Design	Spiralwinkel Helix angle	Abb. Picture	Seite Page
AF - für Stahl und Gusswerkstoffe / for steel and cast materials						
AF50135-... / AF60135-...	3	Schaftfräser end-mill	extra kurz extra short	30°		40
AF61330-...	3	Schaftfräser end-mill	kurz short	30°		41
AF60131-...	3	Schaftfräser end-mill	lang long	30°		42
AF60231-...	3	Schaftfräser end-mill	lang long	45°		43
AF50140-...	4	Schaftfräser end-mill	kurz short	30°		44
AF50140-...R...	4	Schaftfräser end-mill	kurz, mit Eckenradius short, with corner radius	30°		45
AF60140-...X	4	Schaftfräser end-mill	kurz short	30°		46
AF50141-... / AF60141-...	4	Schaftfräser end-mill	lang long	30°		47
AF50141-...R...	4	Schaftfräser end-mill	lang, mit Eckenradius long, with corner radius	30°		48
AF50142-...X / AF60142-...X	4	Schaftfräser end-mill	extra lang extra long	30°		49
AF50340-...	4	Radiusfräser Ball-nose end-mill	kurz short	30°		50

Bezeichnung Description	Schneiden Flutes	Fräsertyp Type	Ausführung Design	Spiralwinkel Helix angle	Abb. Picture	Seite Page
AF - für Stahl und Gusswerkstoffe / for steel and cast materials						
AF502.0-... NEU NEW	4 - 6	Schaftfräser end-mill	kurz short	45°		51
AF50261-... NEU NEW	6	Schaftfräser end-mill	lang long	45°		52
AF614.1-...	3 - 5	Schrupfräser Roughing end-mill	lang long	30°		53
AFJ - für rostfreie Stähle und exotische Werkstoffe / for stainless steel and exotic materials						
AFJ612.1-...	3 - 4	Schaftfräser end-mill	lang long	50°		64
AFJ602.0-...	4 - 8	Schaftfräser end-mill	kurz short	45°		65
AFJ619.1-...	3 - 6	Schrupfräser Roughing end-mill	lang long	45°		66
AFA - für Aluminium und NE-Metalle / for aluminium and non-ferrous machining						
AFA50116-... NEU NEW	1	Schaftfräser end-mill	mittellang mid-length	30°		76
AFA50220-... NEU NEW	2	Schaftfräser end-mill	kurz short	45°		77
AFA51820-...	2	Radiusfräser Ball-nose end-mill	kurz short	50°		78
AFA51521-...	2	Schaftfräser end-mill	lang long	45°		79
AFA50720-...R...	2	Schaftfräser end-mill	lang, mit Eckenradius long, with corner radius	30°		80











Bezeichnung Description	Schneiden Flutes	Fräser Type	Ausführung Design	Spiralwinkel Helix angle	Abb. Picture	Seite Page
AFA - für Aluminium und NE-Metalle / for aluminium and non-ferrous machining						
AFA51522-...	2	Schaftfräser end-mill	extra lang extra long	45°		81
AFA50222-... NEU NEW	2	Schaftfräser end-mill	extra lang extra long	45°		82
AFA51836-... NEU NEW	3	Schaftfräser end-mill	mittellang mid-length	45°		83
AFA52336-... NEU NEW	3	Schaftfräser end-mill	mittellang, abgesetzter Schaft mid-length, with neck	45°		84
AFA52330-...	3	Schaftfräser end-mill	lang long	30°		85
AFA51531-...	3	Schaftfräser end-mill	lang long	45°		86
AFA50231-...R... NEU NEW	3	Schaftfräser end-mill	lang, mit Eckenradius long, with corner radius	45°		87
AFA51532-...	3	Schaftfräser end-mill	extra lang extra long	45°		88
AFA50232-... NEU NEW	3	Schaftfräser end-mill	extra lang extra long	45°		89
AFA51831-...	3	Radiusfräser Ball-nose end-mill	kurz short	40°		92
AFA61431-...	3	Schruppfräser Roughing end-mill	lang long	30°		93

Bezeichnung Description	Schneiden Flutes	Fräsertyp Type	Ausführung Design	Spiralwinkel Helix angle	Abb. Picture	Seite Page
AFA - für Aluminium und NE-Metalle / for aluminium and non-ferrous machining						
AFA51431-...	3	Schruppfräser Roughing end-mill	lang long	30°		94
AFA52131-...	3	Schruppfräser Roughing end-mill	lang long	42°		95
AFA51931-...	NEU NEW 3	Schruppfräser Roughing end-mill	lang long	45°		96
AFA52331-...	NEU NEW 3	Schruppfräser Roughing end-mill	lang, abgesetzter Schaft long, with neck	45°		97
AFD - für Aluminium, Graphit und NE-Metalle / for aluminium, graphite and non-ferrous materials						
AFD50724-...R...	2	Schaftfräser end-mill	mini, mit Eckenradius mini, with corner radius	30°		108
AFD50727-...R...	2	Schaftfräser end-mill	konischer Schaft taper neck	30°		109
AFD50121-...	2	Schaftfräser end-mill	lang long	30°		110
AFD51520-...	2	Schaftfräser end-mill	kurz short	45°		111
AFD51824-...	2	Radiusfräser Ball-nose end-mill	mini	30°		112
AFD50325-...	2	Radiusfräser Ball-nose end-mill	mini	30°		113
AFD51826-...	2	Radiusfräser Ball-nose end-mill	konischer Schaftteil taper neck	30°		114

Bezeichnung Description	Schneiden Flutes	Fräsertyp Type	Ausführung Design	Spiralwinkel Helix angle	Abb. Picture	Seite Page
AFD - für Aluminium, Graphit und NE-Metalle / for aluminium, graphite and non-ferrous materials						
AFD51821-...	2	Radiusfräser Ball-nose end-mill	lang long	30°		115
AFD51823-...	2	Radiusfräser Ball-nose end-mill	überlang extra long	30°		116
AFD51820-...	2	Radiusfräser Ball-nose end-mill	kurz short	30°		117
AFD54030-...R...	3	Schaftfräser end-mill	kurz, mit Eckenradius short, with corner radius	40°		118
AFD54031-...R...	3	Schaftfräser end-mill	lang, mit Eckenradius long, with corner radius	40°		119
AFD51830-...	3	Radiusfräser Ball-nose end-mill	kurz short	30°		120
AFD50740-...R...	4	Schaftfräser end-mill	mit Eckenradius with corner radius	30°		121
AFG - für Stahl und gehärtete Stähle bis 50 HRC / for steel and hardened steel up to 50 HRC						
AFG50120-...	2	Schaftfräser end-mill	kurz short	30°		162
AFG50121-...	2	Schaftfräser end-mill	lang long	30°		163
AFG50321-...	2	Radiusfräser Ball-nose end-mill	lang long	30°		164
AFG50322-...	2	Radiusfräser Ball-nose end-mill	konischer Schaftteil taper neck	30°		165









Bezeichnung Description	Schneiden Flutes	Fräser typ Type	Ausführung Design	Spiralwinkel Helix angle	Abb. Picture	Seite Page
AFG - für Stahl und gehärtete Stähle bis 50 HRC / for steel and hardened steel up to 50 HRC						
AFG52021-...	2	Radiusfräser Ball-nose end-mill	lang (Schlitzfräsen) long (slotting)	30°		166
AFG51621-...	2	Radiusfräser Ball-nose end-mill	lang long	30°		168
AFG50134-.../ AFG60134-...	NEU NEW 3	Schaftfräser end-mill	mini	30°		169
AFG50745-...R...	4	Schaftfräser end-mill	mit Eckenradius with corner radius	30°		170
AFG50140-...	4	Schaftfräser end-mill	kurz short	30°		171
AFG60140-...	NEU NEW 4	Schaftfräser end-mill	kurz short	30°		172
AFG50741-...R...	4	Schaftfräser end-mill	lang, mit Eckenradius long, with corner radius	30°		173
AFG50141-...	4	Schaftfräser end-mill	lang long	30°		174
AFG60141-...	NEU NEW 4	Schaftfräser end-mill	lang long	30°		175
AFG502.0-...	4 - 8	Schaftfräser end-mill	lang long	45°		176
AFG602.0-...	NEU NEW 4 - 8	Schaftfräser end-mill	extra lang extra long	45°		177

Bezeichnung Description	Schneiden Flutes	Fräsertyp Type	Ausführung Design	Spiralwinkel Helix angle	Abb. Picture	Seite Page
AFG - für Stahl und gehärtete Stähle bis 50 HRC / for steel and hardened steel up to 50 HRC						
AFG50861-...R...	6	Schaftfräser end-mill	lang, mit Eckenradius long, with corner radius	45°		178
AFG50262-...	6	Schaftfräser end-mill	extra lang extra long	45°		179
AFG60262-... NEU NEW	6	Schaftfräser end-mill	extra lang extra long	45°		180
AFG606.0-...	3 - 5	Schrupfräser Roughing end-mill	kurz short	20°		181
AFG606.1-...	3 - 5	Schrupfräser Roughing end-mill	lang long	20°		182
AFR - für Stahl, Werkzeugstahl, Gusseisen und gehärtete Werkstoffe / for steel, tool steel, cast iron and pre-hardened steel						
AFR619.0-...	4 - 5	Schrupfräser Roughing end-mill	kurz short	43 - 46°		194
AFR619.1-...	4 - 5	Schrupfräser Roughing end-mill	extra lang extra long	43 - 46°		195
AFR619.2-...	4 - 5	Schrupfräser Roughing end-mill	lang long	43 - 46°		196
AFR619.3-...-PM NEU NEW	4 - 5	Schrupfräser Roughing end-mill	lang long	43 - 46°		197
AFH - für gehärtete Stähle bis 70 HRC und HSC-Bearbeitung / for hardened steel up to 70 HRC and high speed milling						
AFH50120-...	2	Schaftfräser end-mill	mini	30°		204
AFH50526-...	2	Schaftfräser end-mill	mini (Schlitzfräsen) mini (slotting)	30°		205

Bezeichnung Description	Schneiden Flutes	Fräser Type	Ausführung Design	Spiralwinkel Helix angle	Abb. Picture	Seite Page
AFH - für gehärtete Stähle bis 70 HRC und HSC-Bearbeitung / for hardened steel up to 70 HRC and high speed milling						
AFH50920-...R...	2	Schaftfräser end-mill	mini (Schlitzfräsen) mini (slotting)	30°		207
AFH50320-...	2	Radiusfräser Ball-nose end-mill	mini	30°		208
AFH52020-...	2	Radiusfräser Ball-nose end-mill	mini (Schlitzfräsen) mini (slotting)	30°		209
AFH52021-...	2	Radiusfräser Ball-nose end-mill	mini (Schlitzfräsen) mini (slotting)	30°		210
AFH50125-...	2	Schaftfräser end-mill		30°		212
AFH50725-...R...	2	Schaftfräser end-mill	mit Eckenradius with corner radius	30°		213
AFH50926-...R...	2	Schaftfräser end-mill	mit Eckenradius with corner radius	30°		214
AFH51625-...	2	Radiusfräser Ball-nose end-mill		30°		216
AFH51626-...	2	Radiusfräser Ball-nose end-mill		30°		217
AFH51635-...	3	Radiusfräser Ball-nose end-mill		30°		218
AFH50140-...	4	Schaftfräser end-mill		30°		219

Bezeichnung Description	Schneiden Flutes	Fräsertyp Type	Ausführung Design	Spiralwinkel Helix angle	Abb. Picture	Seite Page
AFH - für gehärtete Stähle bis 70 HRC und HSC-Bearbeitung / for hardened steel up to 70 HRC and high speed milling						
AFH50142-...R...	4	Schaftfräser end-mill	mit Eckenradius with corner radius	30°		220
AFH50146-...R...	4	Schaftfräser end-mill	mit Eckenradius with corner radius	30°		221
AFH50745-...R...	4	Schaftfräser end-mill	mit Eckenradius with corner radius	30°		222
AFH50341-...	4	Radiusfräser Ball-nose end-mill		30°		223
AFH50865-...R...	6	Schaftfräser end-mill	mit Eckenradius with corner radius	45°		224
AFH508.1-...	6 - 8	Schaftfräser end-mill	lang long	45°		225
AFH508.2-...	6 - 8	Schaftfräser end-mill	extra lang extra long	45°		226
AFH50746-...R...	4	Hochvorschubfräser High feed end-mill	kurz, mit Eckenradius short, with corner radius	90°		227
AFH50741-...R...	4	Hochvorschubfräser High feed end-mill	lang, mit Eckenradius long, with corner radius	90°		228
AFV - mit ungleicher Drallsteigung (26°-30° / 35°-38°) / with unequal pitch (26° - 30° / 35° - 38°)						
AFV61840-...(R)... (TiAlN)	4	Schaftfräser end-mill	kurz, mit Eckenradius short, with corner radius	35° - 38°		246
AFV61840-...R... (S100)	NEU NEW 4	Schaftfräser end-mill	kurz, mit Eckenradius short, with corner radius	35° - 38°		247

Bezeichnung Description	Schneiden Flutes	Fräser typ Type	Ausführung Design	Spiralwinkel Helix angle	Abb. Picture	Seite Page
AFV - mit ungleicher Drallsteigung (26°-30° / 35°-38°) / with unequal pitch (26° - 30° / 35° - 38°)						
AFV62342-... (S100) NEU NEW	4	Schaftfräser end-mill	kurz short	35 - 38°		248
AFV62342-...R... (S100) NEU NEW	4	Schaftfräser end-mill	kurz short	35 - 38°		249
AFV61841-...R... (TiAIN)	4	Schaftfräser end-mill	lang, mit Eckenradius long, with corner radius	35° - 38°		250
AFV61841-...R... (S100) NEU NEW	4	Schaftfräser end-mill	lang, mit Eckenradius long, with corner radius	35 - 38°		251
AFV60341-... (TiAIN)	4	Radiusfräser Ball-nose end-mill	lang long	35° - 38°		252
AFV61851-... (TiAIN)	5	Schaftfräser end-mill	lang long	35° - 38°		253
AFX - für gehärtete Stähle bis 55 HRC, Stahl und Gusseisen / for pre-hardened steels up to 55 HRC, steel and cast iron						
AFX50124-...R... NEU NEW	2	Schaftfräser end-mill	mini, mit Eckenradius mini, with corner radius	30°		264
AFX50120-... NEU NEW	2	Schaftfräser end-mill	kurz short	30°		268
AFX50121-... NEU NEW	2	Schaftfräser end-mill	lang long	30°		269
AFX50121-...R... NEU NEW	2	Schaftfräser end-mill	lang, mit Eckenradius long, with corner radius	30°		271
AFX50122-... NEU NEW	2	Schaftfräser end-mill	extra lang extra long	30°		273

Bezeichnung Description	Schneiden Flutes	Fräsertyp Type	Ausführung Design	Spiralwinkel Helix angle	Abb. Picture	Seite Page
AFX - für gehärtete Stähle bis 55 HRC, Stahl und Gusseisen / for pre-hardened steels up to 55 HRC, steel and cast iron						
AFX50321-...	NEU NEW 2	Radiusfräser Ball-nose end-mill	lang long	30°		275
AFX52021-...	NEU NEW 2	Radiusfräser Ball-nose end-mill	lang, Schlitzfräsen long, slotting	30°		277
AFX50140-...	NEU NEW 4	Schaftfräser end-mill	kurz short	26 - 30°		279
AFX50041-...R...	NEU NEW 4	Schaftfräser end-mill	lang, mit Eckenradius long, with corner radius	30 - 38°		280
AFX50741-...R...	NEU NEW 4	Schaftfräser end-mill	lang, mit Eckenradius long, with corner radius	30°		283
AFX50042-...	NEU NEW 4	Schaftfräser end-mill	extra lang extra long	35 - 38°		285
AFX50141-...	NEU NEW 4	Schaftfräser end-mill	lang long	30°		286
AFX50142-...	NEU NEW 4	Schaftfräser end-mill	extra lang extra long	30°		288
AFX50260-...	NEU NEW 6	Schaftfräser end-mill	kurz short	45°		289

Weitere Highlights unserer Frässysteme.

Other highlights from our milling range.

ARNO®-Frässystem DUO-MILL

Eckfräsen und HFC-Fräsen
mit nur einem Werkzeug.



ARNO® milling-system DUO-MILL

Square shoulder and high feed
(HFC) milling with just one tool.

ARNO®-Frässystem FTA

Der universelle Planfräser
zur Kostenreduzierung.



ARNO® milling-system FTA

Face milling tool for cost reduction.

ARNO®-Frässystem FOA

Der positiv weichschneidende
Planfräser, der eine Rundplatte
und eine oktagonale Wend-
schneidplatte in einem
Plattensitz vereint.



ARNO® milling-system FOA

The positive face-milling-cutter,
in which both a round and an
octogonal insert can be used.

Informationen zu diesen Produkten finden Sie unter www.arno.de oder direkt bei ARNO®.

For more information on these products please see our website www.arno.de or contact ARNO®.

ARNO®
WERKZEUGE

Weitere Informationen finden Sie unter:
For more information see:

www.arno.de

ARNO[®]

WERKZEUGE

We have a passion for precision.

AUSFÜHRUNG AF

Design AF

Perfekte Leistung.

Great performance.

Vollhartmetallfräser für die allgemeine
Bearbeitung von Stahl, rostfreiem Stahl
und Gusswerkstoffen.

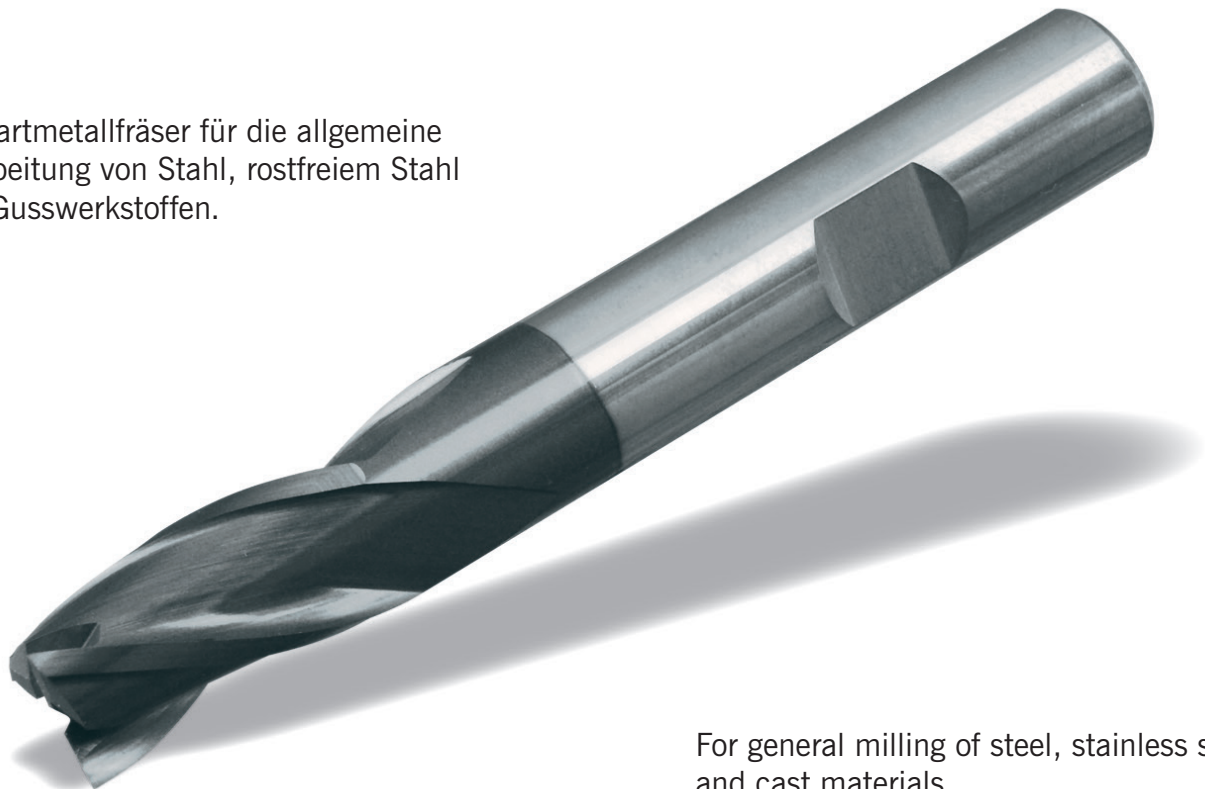

For general milling of steel, stainless steel
and cast materials.

VHM-Schaftfräser

2 Schneiden, Mini-Ausführung

Solid carbide end-mill

2 flutes, mini design

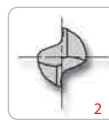

2



30°

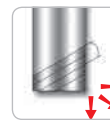

HA

Seite
Page
54-61

TiAlN

Feinstkorn
Ultra micro
granulation

AF50526-...

Schaft / Shank DIN 6535HA	d	d _A	d ₃	l ₁	l ₂	l
AF50526-004A	0,4	4,0	0,37	0,7	2	50
AF50526-004B	0,4	4,0	0,37	0,7	4	50
AF50526-005A	0,5	4,0	0,45	0,75	2	50
AF50526-005B	0,5	4,0	0,45	0,75	4	50
AF50526-005C	0,5	4,0	0,45	0,75	6	50
AF50526-006A	0,6	4,0	0,55	0,9	2	50
AF50526-006B	0,6	4,0	0,55	0,9	4	50
AF50526-006C	0,6	4,0	0,55	0,9	6	50
AF50526-007A	0,7	4,0	0,65	1,1	4	50
AF50526-007B	0,7	4,0	0,65	1,1	6	50
AF50526-008A	0,8	4,0	0,75	1,2	4	50
AF50526-008B	0,8	4,0	0,75	1,2	6	50
AF50526-008C	0,8	4,0	0,75	1,2	8	50
AF50526-009A	0,9	4,0	0,85	1,4	6	50
AF50526-009B	0,9	4,0	0,85	1,4	8	50
AF50526-009C	0,9	4,0	0,85	1,4	10	50
AF50526-010A	1,0	4,0	0,95	1,5	6	50
AF50526-010B	1,0	4,0	0,95	1,5	8	50
AF50526-010C	1,0	4,0	0,95	1,5	10	50
AF50526-010D	1,0	4,0	0,95	1,5	12	50
AF50526-012A	1,2	4,0	1,15	1,8	6	50
AF50526-012B	1,2	4,0	1,15	1,8	8	50
AF50526-012C	1,2	4,0	1,15	1,8	10	50
AF50526-012D	1,2	4,0	1,15	1,8	12	50
AF50526-015A	1,5	4,0	1,45	2,3	6	50
AF50526-015B	1,5	4,0	1,45	2,3	8	50
AF50526-015C	1,5	4,0	1,45	2,3	10	50
AF50526-015D	1,5	4,0	1,45	2,3	12	50
AF50526-015E	1,5	4,0	1,45	2,3	14	50
AF50526-015F	1,5	4,0	1,45	2,3	16	50
AF50526-015G	1,5	4,0	1,45	2,3	18	50
AF50526-015H	1,5	4,0	1,45	2,3	20	50
AF50526-020A	2,0	4,0	1,95	3,0	6	50
AF50526-020B	2,0	4,0	1,95	3,0	8	50
AF50526-020C	2,0	4,0	1,95	3,0	10	50
AF50526-020D	2,0	4,0	1,95	3,0	12	50
AF50526-020E	2,0	4,0	1,95	3,0	14	50
AF50526-020F	2,0	4,0	1,95	3,0	16	50
AF50526-020G	2,0	4,0	1,95	3,0	18	50
AF50526-020H	2,0	4,0	1,95	3,0	20	50
AF50526-025A	2,5	4,0	2,40	3,7	8	50
AF50526-025B	2,5	4,0	2,40	3,7	12	50
AF50526-025C	2,5	4,0	2,40	3,7	16	50

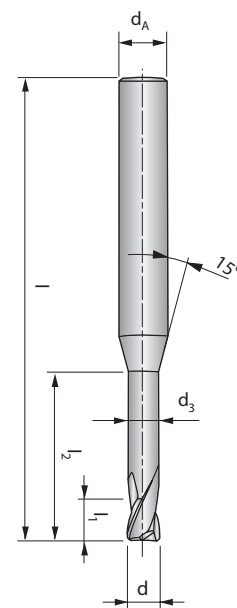

● = Hauptanwendung / Main application
○ = Nebenanwendung / Suitable

Alle Angaben in mm / Dimensions in mm

AF50526-...

Schaft / Shank DIN 6535HA	d	d _A	d ₃	l ₁	l ₂	l
AF50526-025D	2,5	4,0	2,40	3,7	20	50
AF50526-030A	3,0	6,0	2,85	4,5	8	50
AF50526-030B	3,0	6,0	2,85	4,5	12	50
AF50526-030C	3,0	6,0	2,85	4,5	16	60
AF50526-030D	3,0	6,0	2,85	4,5	20	60
AF50526-030E	3,0	6,0	2,85	4,5	25	75
AF50526-040A	4,0	6,0	3,85	6,0	12	50
AF50526-040B	4,0	6,0	3,85	6,0	16	60
AF50526-040C	4,0	6,0	3,85	6,0	20	75
AF50526-040D	4,0	6,0	3,85	6,0	25	75
AF50526-040E	4,0	6,0	3,85	6,0	30	75
AF50526-040F	4,0	6,0	3,85	6,0	35	75

Toleranz / Tolerance	
Fräser / Mill	0 -0,03
Schaft / Shank	h6

VHM-Radiusfräser

2 Schneiden, Mini-Ausführung

Solid carbide ball-nose end-mill

2 flutes, mini design



AF52021-....

Schaft / Shank DIN 6535HA	d	d _A	d ₃	l ₁	l ₂	l	R
AF52021-004A	0,4	4,0	0,37	0,7	2	50	0,20
AF52021-005A	0,5	4,0	0,45	0,75	2	50	0,25
AF52021-005B	0,5	4,0	0,45	0,75	4	50	0,25
AF52021-005C	0,5	4,0	0,45	0,75	6	50	0,25
AF52021-006A	0,6	4,0	0,55	0,9	2	50	0,30
AF52021-006B	0,6	4,0	0,55	0,9	4	50	0,30
AF52021-006C	0,6	4,0	0,55	0,9	6	50	0,30
AF52021-008A	0,8	4,0	0,75	1,2	4	50	0,40
AF52021-008B	0,8	4,0	0,75	1,2	6	50	0,40
AF52021-008C	0,8	4,0	0,75	1,2	8	50	0,40
AF52021-010A	1,0	4,0	0,95	1,5	6	50	0,50
AF52021-010B	1,0	4,0	0,95	1,5	8	50	0,50
AF52021-010C	1,0	4,0	0,95	1,5	10	50	0,50
AF52021-010D	1,0	4,0	0,95	1,5	12	50	0,50
AF52021-012A	1,2	4,0	1,15	1,8	8	50	0,60
AF52021-012B	1,2	4,0	1,15	1,8	12	50	0,60
AF52021-014A	1,4	4,0	1,35	2,1	16	50	0,70
AF52021-015A	1,5	4,0	1,45	2,3	6	50	0,75
AF52021-015B	1,5	4,0	1,45	2,3	8	50	0,75
AF52021-015C	1,5	4,0	1,45	2,3	10	50	0,75
AF52021-015D	1,5	4,0	1,45	2,3	12	50	0,75
AF52021-015E	1,5	4,0	1,45	2,3	16	50	0,75
AF52021-015F	1,5	4,0	1,45	2,3	20	50	0,75
AF52021-016A	1,6	4,0	1,55	2,4	8	50	0,80
AF52021-016B	1,6	4,0	1,55	2,4	12	50	0,80
AF52021-016C	1,6	4,0	1,55	2,4	16	50	0,80
AF52021-016D	1,6	4,0	1,55	2,4	20	50	0,80
AF52021-020A	2,0	4,0	1,95	3,0	8	50	1,00
AF52021-020B	2,0	4,0	1,95	3,0	10	50	1,00
AF52021-020C	2,0	4,0	1,95	3,0	12	50	1,00
AF52021-020D	2,0	4,0	1,95	3,0	14	50	1,00
AF52021-020E	2,0	4,0	1,95	3,0	16	50	1,00
AF52021-020F	2,0	4,0	1,95	3,0	20	50	1,00
AF52021-030A	3,0	6,0	2,85	4,5	10	50	1,50
AF52021-030B	3,0	6,0	2,85	4,5	12	50	1,50
AF52021-030C	3,0	6,0	2,85	4,5	16	60	1,50
AF52021-030D	3,0	6,0	2,85	4,5	20	60	1,50
AF52021-030E	3,0	6,0	2,85	4,5	25	75	1,50
AF52021-040A	4,0	6,0	3,85	6,0	12	50	2,00
AF52021-040B	4,0	6,0	3,85	6,0	16	60	2,00
AF52021-040C	4,0	6,0	3,85	6,0	20	75	2,00
AF52021-040D	4,0	6,0	3,85	6,0	25	75	2,00
AF52021-040E	4,0	6,0	3,85	6,0	30	75	2,00

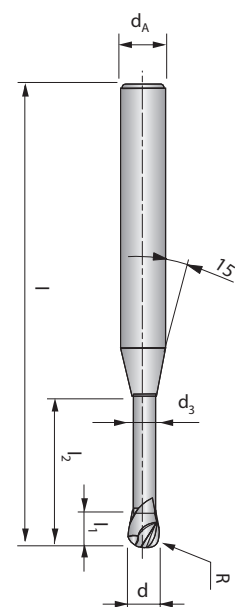

Toleranz / Tolerance	
Fräser / Mill	0 -0,03
Radius / Radius	± 0,02
Schaft / Shank	h6

● = Hauptanwendung / Main application
○ = Nebenanwendung / Suitable

Alle Angaben in mm / Dimensions in mm

VHM-Schaftfräser

2 Schneiden, kurze Ausführung



Solid carbide end-mill

2 flutes, short design

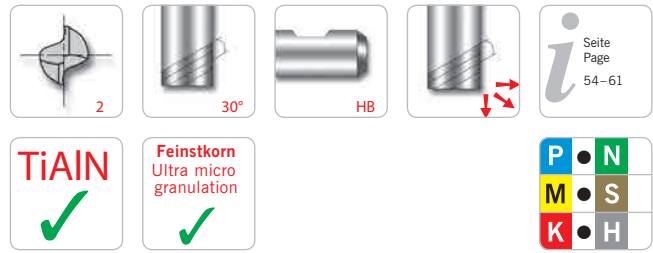

AF60125-...

Schaft / Shank DIN 6535HB	d	d _A	l ₁	l
AF60125-020	2,0	6,0	3,0	50
AF60125-030	3,0	6,0	4,0	50
AF60125-035	3,5	6,0	4,0	50
AF60125-040	4,0	6,0	5,0	54
AF60125-045	4,5	6,0	5,0	54
AF60125-050	5,0	6,0	6,0	54
AF60125-060	6,0	6,0	7,0	54
AF60125-070	7,0	8,0	8,0	58
AF60125-080	8,0	8,0	9,0	58
AF60125-090	9,0	10,0	10,0	66
AF60125-100	10,0	10,0	11,0	66
AF60125-120	12,0	12,0	12,0	73
AF60125-140	14,0	14,0	14,0	75
AF60125-160	16,0	16,0	16,0	82
AF60125-180	18,0	18,0	18,0	84
AF60125-200	20,0	20,0	20,0	92

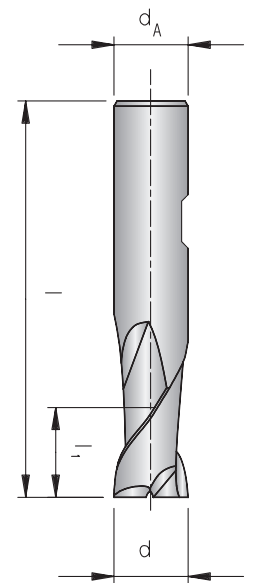

Toleranz / Tolerance	
Fräser / Mill	0 -0,03
Schaft / Shank	h6

● = Hauptanwendung / Main application
○ = Nebenanwendung / Suitable

Alle Angaben in mm / Dimensions in mm

VHM-Schaftfräser

2 Schneiden, kurze Ausführung mit Eckenradius



Solid carbide end-mill

2 flutes, short design with corner radius

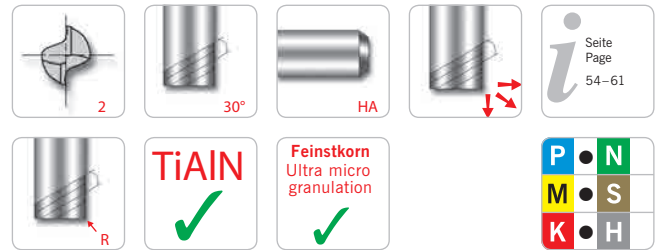

Seite
Page
54-61



AF50120-...R...

Schaft / Shank DIN 6535HA	d	d _A	l ₁	l	R
AF50120-020R0,2	2,0	4,0	4,0	50	0,20
AF50120-020R0,3	2,0	4,0	4,0	50	0,30
AF50120-020R0,5	2,0	4,0	4,0	50	0,50
AF50120-025R0,2	2,5	4,0	5,0	50	0,20
AF50120-025R0,3	2,5	4,0	5,0	50	0,30
AF50120-025R0,5	2,5	4,0	5,0	50	0,50
AF50120-030R0,2	3,0	4,0	6,0	50	0,20
AF50120-030R0,3	3,0	4,0	6,0	50	0,30
AF50120-030R0,5	3,0	4,0	6,0	50	0,50
AF50120-030R1,0	3,0	4,0	6,0	50	1,00
AF50120-040R0,2	4,0	4,0	8,0	50	0,20
AF50120-040R0,3	4,0	4,0	8,0	50	0,30
AF50120-040R0,5	4,0	4,0	8,0	50	0,50
AF50120-040R1,0	4,0	4,0	8,0	50	1,00
AF50120-050R0,2	5,0	6,0	10,0	50	0,20
AF50120-050R0,3	5,0	6,0	10,0	50	0,30
AF50120-050R0,5	5,0	6,0	10,0	50	0,50
AF50120-050R1,0	5,0	6,0	10,0	50	1,00
AF50120-060R0,2	6,0	6,0	12,0	50	0,20
AF50120-060R0,3	6,0	6,0	12,0	50	0,30
AF50120-060R0,5	6,0	6,0	12,0	50	0,50
AF50120-060R1,0	6,0	6,0	12,0	50	1,00
AF50120-080R0,5	8,0	8,0	16,0	60	0,50
AF50120-080R1,0	8,0	8,0	16,0	60	1,00
AF50120-080R1,5	8,0	8,0	16,0	60	1,50
AF50120-080R2,0	8,0	8,0	16,0	60	2,00
AF50120-080R2,5	8,0	8,0	16,0	60	2,50
AF50120-100R0,5	10,0	10,0	20,0	75	0,50
AF50120-100R1,0	10,0	10,0	20,0	75	1,00
AF50120-100R1,5	10,0	10,0	20,0	75	1,50
AF50120-100R2,0	10,0	10,0	20,0	75	2,00
AF50120-100R2,5	10,0	10,0	20,0	75	2,50
AF50120-120R0,5	12,0	12,0	24,0	75	0,50
AF50120-120R1,0	12,0	12,0	24,0	75	1,00
AF50120-120R1,5	12,0	12,0	24,0	75	1,50
AF50120-120R2,0	12,0	12,0	24,0	75	2,00
AF50120-120R2,5	12,0	12,0	24,0	75	2,50

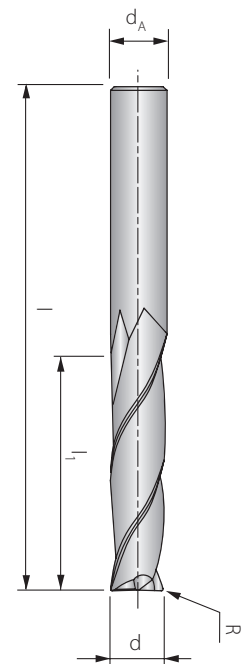

Toleranz / Tolerance	
Fräser / Mill	0 -0,03
Radius / Radius	± 0,03
Schaft / Shank	h6

● = Hauptanwendung / Main application
○ = Nebenanwendung / Suitable

Alle Angaben in mm / Dimensions in mm

VHM-Schaftfräser

2 Schneiden, lange Ausführung



Solid carbide end-mill

2 flutes, long design

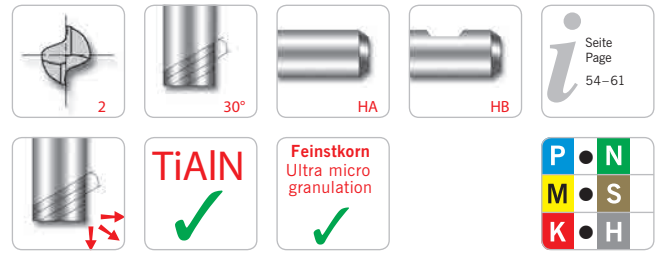

i Seite Page 54-61



AF50121-... / AF60121-...

Schaft / Shank DIN 6535HA / HB	d	d _A	l ₁	l
AF50121-020*	2,0	3,0	6,0	38
AF60121-028	2,8	6,0	7,0	57
AF60121-030	3,0	6,0	7,0	57
AF60121-035	3,5	6,0	7,0	57
AF60121-038	3,8	6,0	8,0	57
AF60121-040	4,0	6,0	8,0	57
AF60121-045	4,5	6,0	8,0	57
AF60121-048	4,8	6,0	10,0	57
AF60121-050	5,0	6,0	10,0	57
AF60121-055 N	5,5	6,0	10,0	57
AF60121-057	5,75	6,0	10,0	57
AF60121-060	6,0	6,0	10,0	57
AF60121-065	6,5	8,0	13,0	63
AF60121-067	6,75	8,0	13,0	63
AF60121-070	7,0	8,0	13,0	63
AF60121-075	7,5	8,0	16,0	63
AF60121-077	7,75	8,0	16,0	63
AF60121-080	8,0	8,0	16,0	63
AF60121-087	8,7	10,0	16,0	72
AF60121-090	9,0	10,0	16,0	72
AF60121-095	9,5	10,0	19,0	72
AF60121-097	9,7	10,0	19,0	72
AF60121-100	10,0	10,0	19,0	72
AF60121-105	10,5	12,0	22,0	83
AF60121-110	11,0	12,0	22,0	83
AF60121-117	11,7	12,0	22,0	83
AF60121-120	12,0	12,0	22,0	83
AF60121-137	13,7	14,0	22,0	83
AF60121-140	14,0	14,0	22,0	83
AF60121-150	15,0	16,0	26,0	92
AF60121-157	15,7	16,0	26,0	92
AF60121-160	16,0	16,0	26,0	92
AF60121-177	17,7	18,0	26,0	92
AF60121-180	18,0	18,0	26,0	92
AF60121-197	19,7	20,0	32,0	104
AF60121-200	20,0	20,0	32,0	104

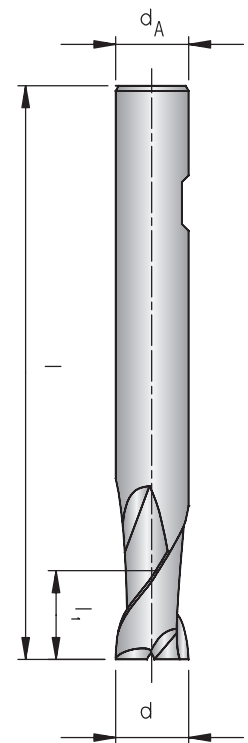

Toleranz / Tolerance	
Fräser / Mill	0 -0,03
Schaft / Shank	h6

* Zylinderschaft nach DIN 6535HA ohne Mitnahmefläche
* Cylindrical shank to DIN 6535HA, no flat

● = Hauptanwendung / Main application
○ = Nebenanwendung / Suitable

Alle Angaben in mm / Dimensions in mm

VHM-Schaftfräser

2 Schneiden, lange Ausführung mit Eckenradius



Solid carbide end-mill

2 flutes, long design with corner radius

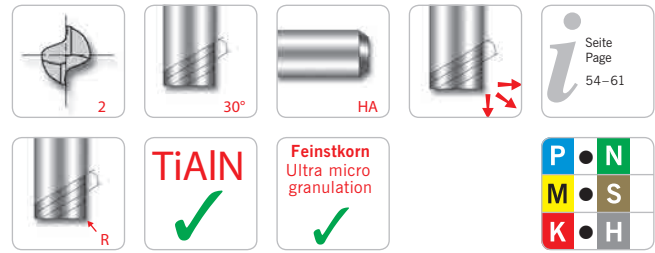

AF50121-...R...

Schaft / Shank DIN 6535HA	d	d _A	l ₁	l	R
AF50121-030R0,5	3,0	4,0	6,0	75	0,50
AF50121-030R1,0	3,0	4,0	6,0	75	1,00
AF50121-040R0,5	4,0	4,0	8,0	75	0,50
AF50121-040R1,0	4,0	4,0	8,0	75	1,00
AF50121-050R0,5	5,0	6,0	10,0	75	0,50
AF50121-050R1,0	5,0	6,0	10,0	75	1,00
AF50121-060R0,5	6,0	6,0	12,0	75	0,50
AF50121-060R1,0	6,0	6,0	12,0	75	1,00
AF50121-080R0,5	8,0	8,0	16,0	100	0,50
AF50121-080R1,0	8,0	8,0	16,0	100	1,00
AF50121-080R1,5	8,0	8,0	16,0	100	1,50
AF50121-080R2,0	8,0	8,0	16,0	100	2,00
AF50121-080R2,5	8,0	8,0	16,0	100	2,50
AF50121-100R0,5	10,0	10,0	20,0	100	0,50
AF50121-100R1,0	10,0	10,0	20,0	100	1,00
AF50121-100R1,5	10,0	10,0	20,0	100	1,50
AF50121-100R2,0	10,0	10,0	20,0	100	2,00
AF50121-100R2,5	10,0	10,0	20,0	100	2,50
AF50121-120R0,5	12,0	12,0	24,0	100	0,50
AF50121-120R1,0	12,0	12,0	24,0	100	1,00
AF50121-120R1,5	12,0	12,0	24,0	100	1,50
AF50121-120R2,0	12,0	12,0	24,0	100	2,00
AF50121-120R2,5	12,0	12,0	24,0	100	2,50

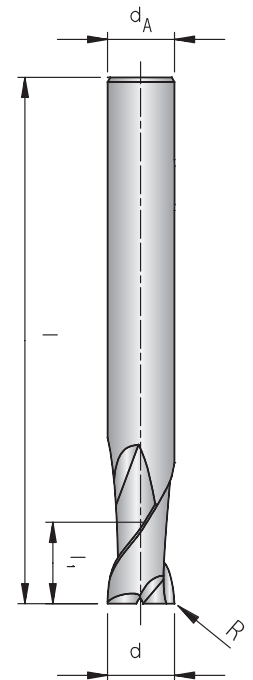

Toleranz / Tolerance

Fräser / Mill	0 -0,03
Radius / Radius	± 0,03
Schaft / Shank	h6

● = Hauptanwendung / Main application
○ = Nebenanwendung / Suitable

Alle Angaben in mm / Dimensions in mm

VHM-Schaftfräser

2 Schneiden, extra lange Ausführung

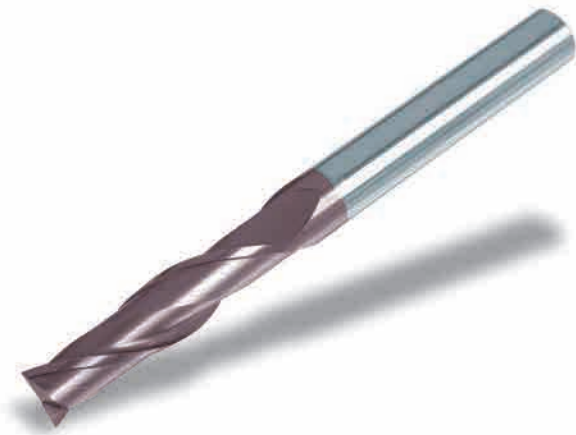

Solid carbide end-mill

2 flutes, extra long design

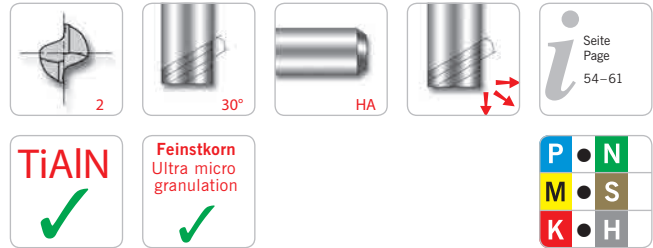

i Seite
Page
54-61

P	●	N
M	●	S
K	●	H

AF50122-...

Schaft / Shank DIN 6535HA	d	d _A	l ₁	l
AF50122-030	3,0	3,0	20,0	60
AF50122-040	4,0	4,0	20,0	60
AF50122-050	5,0	5,0	25,0	75
AF50122-060	6,0	6,0	30,0	75
AF50122-080	8,0	8,0	30,0	75
AF50122-100	10,0	10,0	40,0	100
AF50122-120	12,0	12,0	45,0	100
AF50122-140	14,0	14,0	45,0	100
AF50122-160	16,0	16,0	45,0	100
AF50122-180	18,0	18,0	45,0	100
AF50122-200	20,0	20,0	45,0	100

Toleranz / Tolerance	
Fräser / Mill	0 -0,03
Schaft / Shank	h6

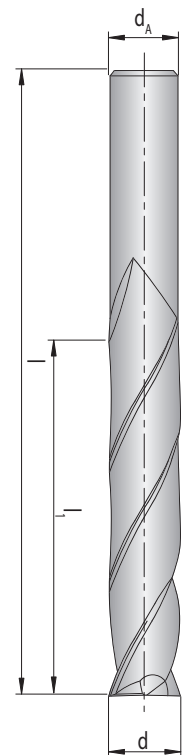

● = Hauptanwendung / Main application
○ = Nebenanwendung / Suitable

Alle Angaben in mm / Dimensions in mm

VHM-Radiusfräser

2 Schneiden, kurze Ausführung

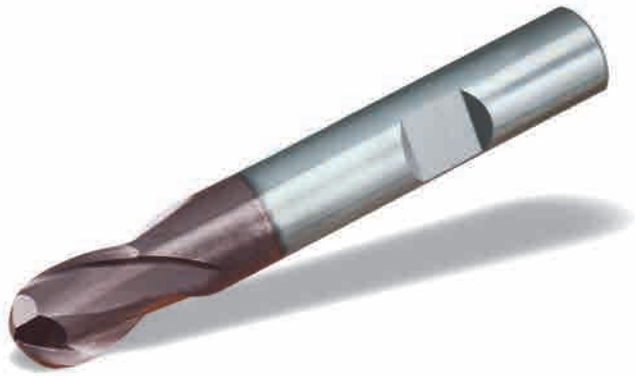

Solid carbide ball-nose end-mill

2 flutes, short design

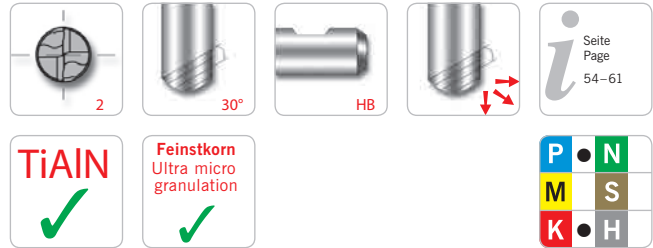

AF60320-...

Schaft / Shank DIN 6535HB	d	d _A	l ₁	l
AF60320-020	2,0	6,0	3,0	50
AF60320-030	3,0	6,0	4,0	50
AF60320-040	4,0	6,0	5,0	54
AF60320-050	5,0	6,0	6,0	54
AF60320-060	6,0	6,0	7,0	54
AF60320-080	8,0	8,0	9,0	58
AF60320-100	10,0	10,0	11,0	66
AF60320-120	12,0	12,0	12,0	73
AF60320-140	14,0	14,0	14,0	75
AF60320-160	16,0	16,0	16,0	82
AF60320-180	18,0	18,0	18,0	84
AF60320-200	20,0	20,0	20,0	92

Toleranz / Tolerance	
Fräser / Mill	0 -0,03
Radius / Radius	± 0,02
Schaft / Shank	h6

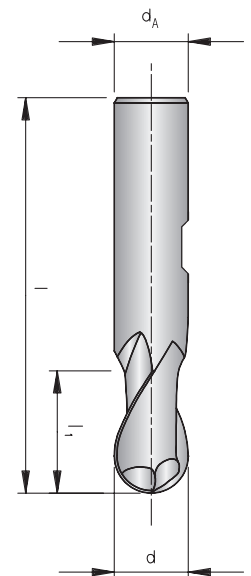

VHM-Radiusfräser

2 Schneiden, lange Ausführung

Solid carbide ball-nose end-mill

2 flutes, long design

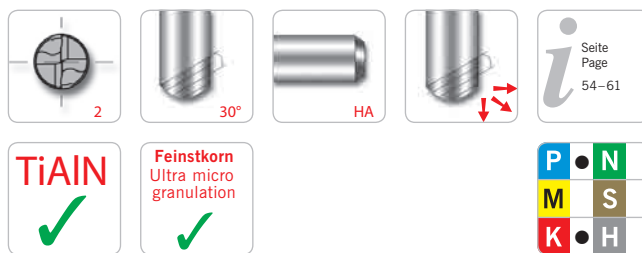

AF50321-...

Schaft / Shank DIN 6535HA	d	d _A	l ₁	l
AF50321-030	3,0	3,0	5,0	75
AF50321-040	4,0	4,0	8,0	75
AF50321-050	5,0	5,0	9,0	75
AF50321-060	6,0	6,0	10,0	100
AF50321-080	8,0	8,0	12,0	100
AF50321-100	10,0	10,0	14,0	100
AF50321-120	12,0	12,0	16,0	100
AF50321-140	14,0	14,0	18,0	100
AF50321-160	16,0	16,0	22,0	150
AF50321-200	20,0	20,0	26,0	150

Toleranz / Tolerance	
Fräser / Mill	0 -0,03
Radius / Radius	± 0,02
Schaft / Shank	h6

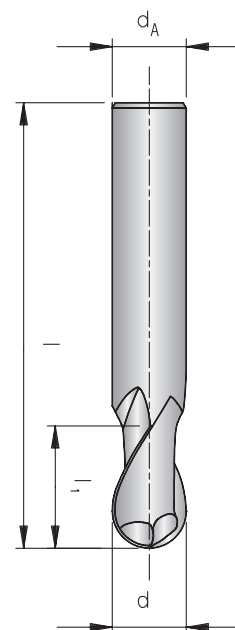

● = Hauptanwendung / Main application
○ = Nebenanwendung / Suitable

Alle Angaben in mm / Dimensions in mm

VHM-Radiusfräser

2 Schneiden, lange Ausführung

Solid carbide ball-nose end-mill

2 flutes, long design

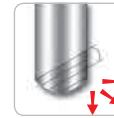
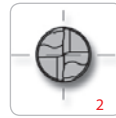
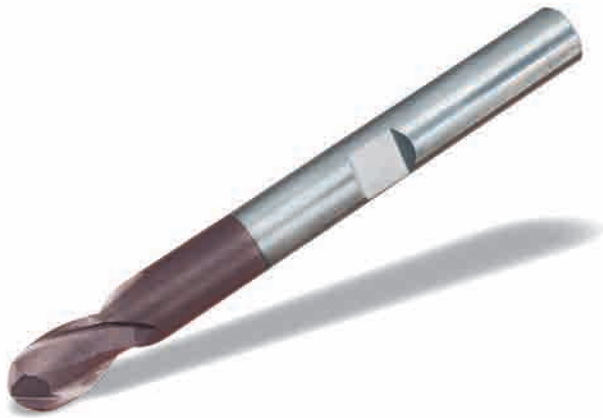

AF60321-....

Schaft / Shank DIN 6535HB	d	d _A	l ₁	l
AF60321-030	3,0	6,0	7,0	57
AF60321-040	4,0	6,0	8,0	57
AF60321-050	5,0	6,0	10,0	57
AF60321-060	6,0	6,0	10,0	57
AF60321-080	8,0	8,0	16,0	63
AF60321-100	10,0	10,0	19,0	72
AF60321-120	12,0	12,0	22,0	83
AF60321-140	14,0	14,0	22,0	83
AF60321-160	16,0	16,0	26,0	92
AF60321-180	18,0	18,0	26,0	92
AF60321-200	20,0	20,0	32,0	104

Toleranz / Tolerance	
Fräser / Mill	0 -0,03
Radius / Radius	± 0,02
Schaft / Shank	h6

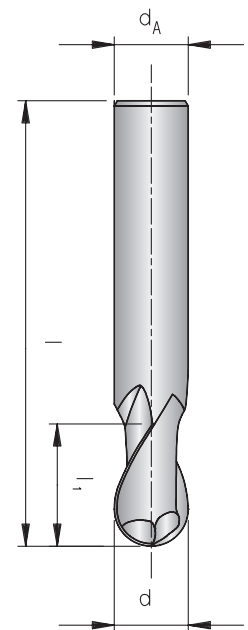

● = Hauptanwendung / Main application
○ = Nebenanwendung / Suitable

Alle Angaben in mm / Dimensions in mm

VHM-Radiusfräser

2 Schneiden, extra lange Ausführung



Solid carbide ball-nose end-mill

2 flutes, extra long design

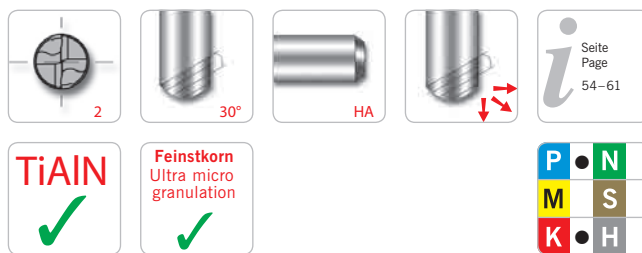

AF50322-...

Schaft / Shank DIN 6535HA	d	d _A	l ₁	l
AF50322-030	3,0	3,0	20,0	60
AF50322-040	4,0	4,0	20,0	60
AF50322-050	5,0	5,0	25,0	75
AF50322-060	6,0	6,0	30,0	75
AF50322-080	8,0	8,0	30,0	75
AF50322-100	10,0	10,0	40,0	100
AF50322-120	12,0	12,0	45,0	100
AF50322-140	14,0	14,0	45,0	100
AF50322-160	16,0	16,0	45,0	100
AF50322-180	18,0	18,0	45,0	100
AF50322-200	20,0	20,0	45,0	100

Toleranz / Tolerance	
Fräser / Mill	0 -0,03
Radius / Radius	± 0,02
Schaft / Shank	h6

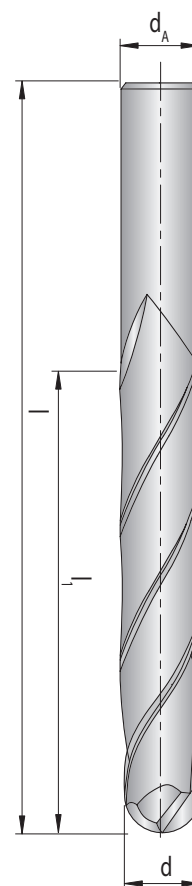

● = Hauptanwendung / Main application
○ = Nebenanwendung / Suitable

Alle Angaben in mm / Dimensions in mm

VHM-Schaftfräser

3 Schneiden, extra kurze Ausführung



Solid carbide end-mill

3 flutes, extra short design

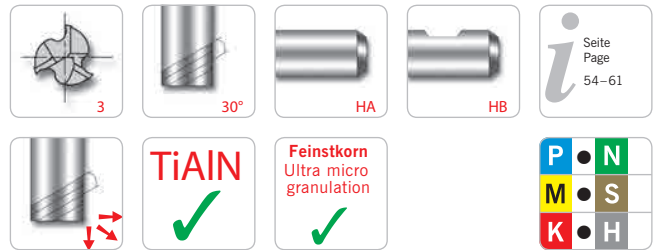

AF50135-... / AF60135-...

Schaft / Shank DIN 6535HA / HB	d	d _A	l ₁	l
AF50135-005*	0,5	3,0	1,5	38
AF50135-006*	0,6	3,0	1,5	38
AF50135-008*	0,8	3,0	2,0	38
AF50135-010*	1,0	3,0	2,0	38
AF50135-012*	1,2	3,0	2,0	38
AF50135-015*	1,5	3,0	2,0	38
AF50135-018*	1,8	3,0	2,0	38
AF60135-020	2,0	6,0	4,0	35
AF60135-025	2,5	6,0	5,0	36
AF60135-030	3,0	6,0	5,0	36
AF60135-035	3,5	6,0	6,0	37
AF60135-040	4,0	6,0	7,0	38
AF60135-045	4,5	6,0	8,0	38
AF60135-050	5,0	6,0	8,0	39
AF60135-055	5,5	6,0	8,0	39
AF60135-0575	5,75	6,0	8,0	39
AF60135-060	6,0	6,0	8,0	39
AF60135-065	6,5	8,0	10,0	42
AF60135-0675	6,75	8,0	10,0	42
AF60135-070	7,0	8,0	10,0	42
AF60135-075	7,5	8,0	11,0	43
AF60135-0775	7,75	8,0	10,0	42
AF60135-080	8,0	8,0	11,0	43
AF60135-085	8,5	10,0	13,0	50
AF60135-087	8,7	10,0	11,0	48
AF60135-090	9,0	10,0	11,0	48
AF60135-095	9,5	10,0	13,0	50
AF60135-097	9,7	10,0	11,0	48
AF60135-100	10,0	10,0	13,0	50
AF60135-105	10,5	12,0	15,0	55
AF60135-110	11,0	12,0	15,0	55
AF60135-115	11,5	12,0	15,0	55
AF60135-120	12,0	12,0	15,0	55
AF60135-130	13,0	14,0	15,0	58
AF60135-140	14,0	14,0	15,0	58
AF60135-150	15,0	16,0	18,0	62
AF60135-160	16,0	16,0	18,0	62
AF60135-180	18,0	18,0	20,0	70
AF60135-200	20,0	20,0	22,0	75

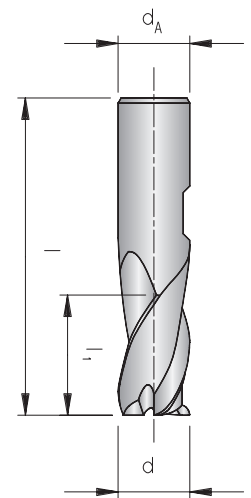

Toleranz / Tolerance	
Fräser / Mill	0 -0,03
Schaft / Shank	h6

* Zylinderschaft nach DIN 6535HA ohne Mitnahmefläche
* Cylindrical shank to DIN 6535HA, no flat

● = Hauptanwendung / Main application
○ = Nebenanwendung / Suitable

Alle Angaben in mm / Dimensions in mm

VHM-Schaftfräser

3 Schneiden, kurze Ausführung



Solid carbide end-mill

3 flutes, short design



AF61330-...

Schaft / Shank DIN 6535HB	d	d _A	l ₁	l
AF61330-020	2,0	6,0	3,0	50
AF61330-030	3,0	6,0	4,0	50
AF61330-035	3,5	6,0	4,0	50
AF61330-040	4,0	6,0	5,0	54
AF61330-045	4,5	6,0	5,0	54
AF61330-050	5,0	6,0	6,0	54
AF61330-060	6,0	6,0	7,0	54
AF61330-070	7,0	8,0	8,0	58
AF61330-080	8,0	8,0	9,0	58
AF61330-090	9,0	10,0	10,0	66
AF61330-100	10,0	10,0	11,0	66
AF61330-120	12,0	12,0	12,0	73
AF61330-140	14,0	14,0	14,0	75
AF61330-160	16,0	16,0	16,0	82
AF61330-180	18,0	18,0	18,0	84
AF61330-200	20,0	20,0	20,0	92

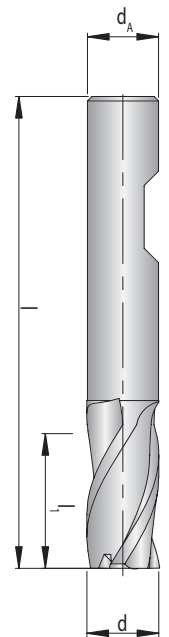

Toleranz / Tolerance	
Fräser / Mill	0 -0,03
Schaft / Shank	h6

● = Hauptanwendung / Main application
○ = Nebenanwendung / Suitable

Alle Angaben in mm / Dimensions in mm

VHM-Schaftfräser

3 Schneiden, lange Ausführung



Solid carbide end-mill

3 flutes, long design



AF60131-...

Schaft / Shank DIN 6535HB	d	d _A	l ₁	l
AF60131-030	3,0	6,0	7,0	57
AF60131-040	4,0	6,0	8,0	57
AF60131-050	5,0	6,0	10,0	57
AF60131-060	6,0	6,0	10,0	57
AF60131-080	8,0	8,0	16,0	63
AF60131-090	9,0	10,0	16,0	72
AF60131-100	10,0	10,0	19,0	72
AF60131-120	12,0	12,0	22,0	83
AF60131-140	14,0	14,0	22,0	83
AF60131-160	16,0	16,0	26,0	92
AF60131-180	18,0	18,0	26,0	92
AF60131-200	20,0	20,0	32,0	104

Toleranz / Tolerance

Fräser / Mill	0 -0,03
Schaft / Shank	h6

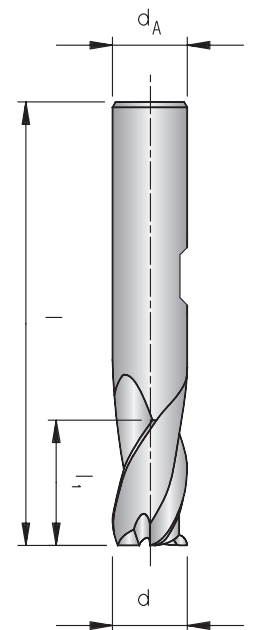

VHM-Schaftfräser

3 Schneiden, lange Ausführung

Solid carbide end-mill

3 flutes, long design

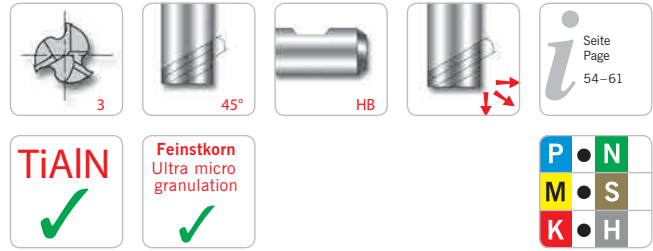
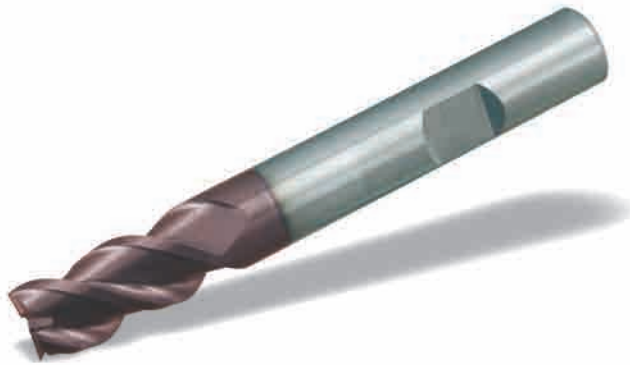

AF60231-...

Schaft / Shank DIN 6535HB	d	d _A	l ₁	l
AF60231-030	3,0	6,0	7,0	57
AF60231-035	3,5	6,0	7,0	57
AF60231-040	4,0	6,0	8,0	57
AF60231-045	4,5	6,0	8,0	57
AF60231-050	5,0	6,0	10,0	57
AF60231-060	6,0	6,0	10,0	57
AF60231-070	7,0	8,0	13,0	63
AF60231-080	8,0	8,0	16,0	63
AF60231-090	9,0	10,0	16,0	72
AF60231-100	10,0	10,0	19,0	72
AF60231-120	12,0	12,0	22,0	83
AF60231-140	14,0	14,0	22,0	83
AF60231-160	16,0	16,0	26,0	92
AF60231-180	18,0	18,0	26,0	92
AF60231-200	20,0	20,0	32,0	104

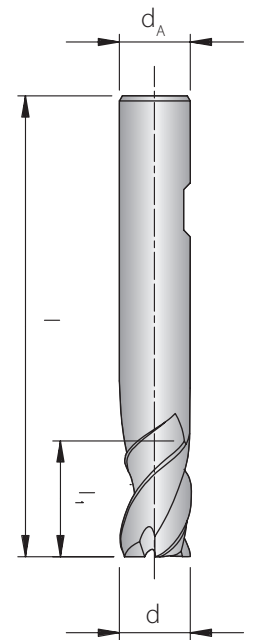

Toleranz / Tolerance	
Fräser / Mill	⁰ -0,03
Schaft / Shank	h6

SET-AF60231 TiAlN

SET-Inhalt SET, contains [Stück / Pcs.]	Schaft Shank	d	d _A	l ₁	l
2x -->	AF60231-060	6,0	6	10	57
2x -->	AF60231-080	8,0	8	16	63
2x -->	AF60231-100	10,0	10	19	72
2x -->	AF60231-120	12,0	12	22	83



Bestellbezeichnung / Ordering description: SET-AF60231 TiAlN

● = Hauptanwendung / Main application
○ = Nebenanwendung / Suitable

Alle Angaben in mm / Dimensions in mm

VHM-Schaftfräser

4 Schneiden, kurze Ausführung

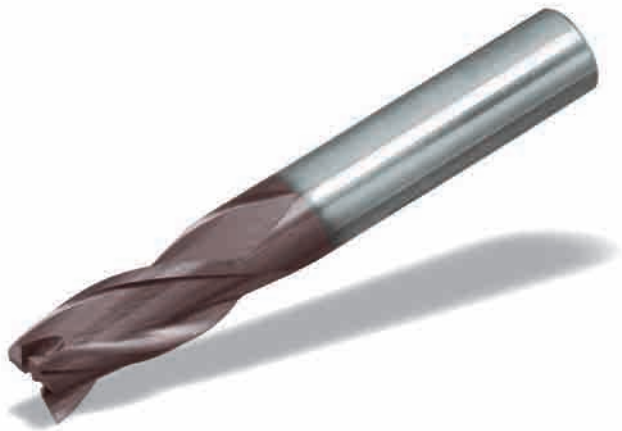

Solid carbide end-mill

4 flutes, short design

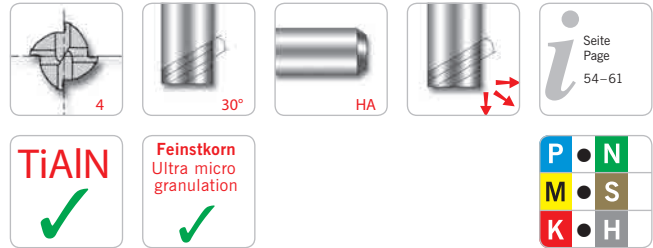

AF50140-...

Schaft / Shank DIN 6535HA	d	d _A	l ₁	l
AF50140-010	1,0	4,0	3,0	40
AF50140-015	1,5	4,0	4,5	40
AF50140-020	2,0	2,0	8,0	32
AF50140-025	2,5	2,5	8,0	32
AF50140-030	3,0	3,0	12,0	32
AF50140-035	3,5	3,5	12,0	32
AF50140-040	4,0	4,0	12,0	40
AF50140-045	4,5	4,5	14,0	50
AF50140-050	5,0	5,0	14,0	50
AF50140-055	5,5	5,5	16,0	50
AF50140-060	6,0	6,0	16,0	50
AF50140-070	7,0	7,0	20,0	60
AF50140-080	8,0	8,0	20,0	60
AF50140-090	9,0	9,0	20,0	60
AF50140-100	10,0	10,0	22,0	70
AF50140-120	12,0	12,0	22,0	70
AF50140-140	14,0	14,0	25,0	75
AF50140-160	16,0	16,0	25,0	75
AF50140-200	20,0	20,0	32,0	100

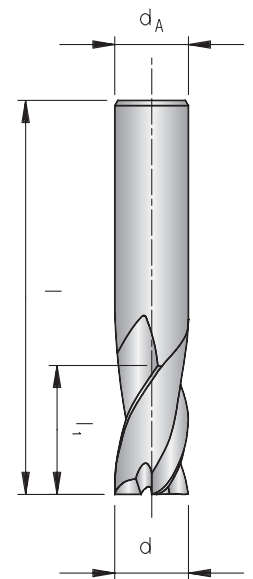

Toleranz / Tolerance	
Fräser / Mill	0 -0,03
Schaft / Shank	h6

● = Hauptanwendung / Main application
○ = Nebenanwendung / Suitable

Alle Angaben in mm / Dimensions in mm

VHM-Schaftfräser

4 Schneiden, kurze Ausführung mit Eckenradius



Solid carbide end-mill

4 flutes, short design with corner radius

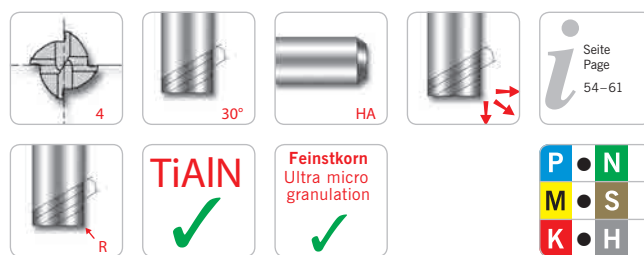

AF50140-...R...

Schaft / Shank DIN 6535HA	d	d _A	l ₁	l	R
AF50140-020R0,2	2,0	4,0	4,0	50	0,20
AF50140-020R0,3	2,0	4,0	4,0	50	0,30
AF50140-020R0,5	2,0	4,0	4,0	50	0,50
AF50140-025R0,2	2,5	4,0	5,0	50	0,20
AF50140-025R0,3	2,5	4,0	5,0	50	0,30
AF50140-025R0,5	2,5	4,0	5,0	50	0,50
AF50140-030R0,2	3,0	4,0	6,0	50	0,20
AF50140-030R0,3	3,0	4,0	6,0	50	0,30
AF50140-030R0,5	3,0	4,0	6,0	50	0,50
AF50140-030R1,0	3,0	4,0	6,0	50	1,00
AF50140-040R0,2	4,0	4,0	8,0	50	0,20
AF50140-040R0,3	4,0	4,0	8,0	50	0,30
AF50140-040R0,5	4,0	4,0	8,0	50	0,50
AF50140-040R1,0	4,0	4,0	8,0	50	1,00
AF50140-050R0,2	5,0	6,0	10,0	50	0,20
AF50140-050R0,3	5,0	6,0	10,0	50	0,30
AF50140-050R0,5	5,0	6,0	10,0	50	0,50
AF50140-050R1,0	5,0	6,0	10,0	50	1,00
AF50140-060R0,2	6,0	6,0	12,0	50	0,20
AF50140-060R0,3	6,0	6,0	12,0	50	0,30
AF50140-060R0,5	6,0	6,0	12,0	50	0,50
AF50140-060R1,0	6,0	6,0	12,0	50	1,00
AF50140-080R0,5	8,0	8,0	16,0	60	0,50
AF50140-080R1,0	8,0	8,0	16,0	60	1,00
AF50140-080R1,5	8,0	8,0	16,0	60	1,50
AF50140-080R2,0	8,0	8,0	16,0	60	2,00
AF50140-080R2,5	8,0	8,0	16,0	60	2,50
AF50140-100R0,5	10,0	10,0	20,0	75	0,50
AF50140-100R1,0	10,0	10,0	20,0	75	1,00
AF50140-100R1,5	10,0	10,0	20,0	75	1,50
AF50140-100R2,0	10,0	10,0	20,0	75	2,00
AF50140-100R2,5	10,0	10,0	20,0	75	2,50
AF50140-120R0,5	12,0	12,0	24,0	75	0,50
AF50140-120R1,0	12,0	12,0	24,0	75	1,00
AF50140-120R1,5	12,0	12,0	24,0	75	1,50
AF50140-120R2,0	12,0	12,0	24,0	75	2,00
AF50140-120R2,5	12,0	12,0	24,0	75	2,50

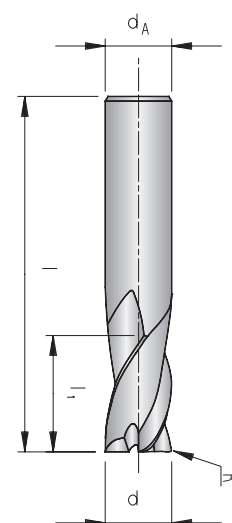

Toleranz / Tolerance	
Fräser / Mill	0 -0,03
Radius / Radius	± 0,03
Schaft / Shank	h6

● = Hauptanwendung / Main application
○ = Nebenanwendung / Suitable

Alle Angaben in mm / Dimensions in mm

VHM-Schaftfräser

4 Schneiden, kurze Ausführung

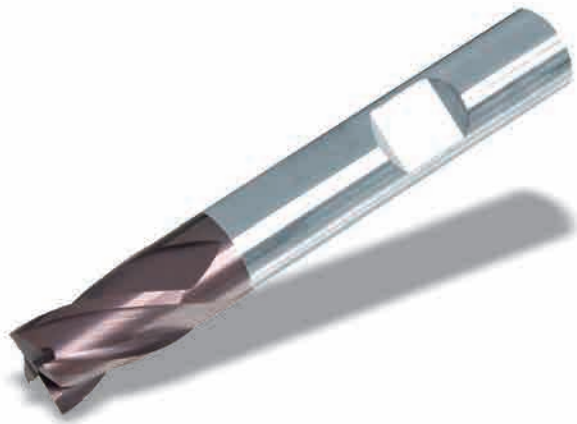

Solid carbide end-mill

4 flutes, short design



AF60140-... X

Schaft / Shank DIN 6535HB	d	d _A	l ₁	l
AF60140-020X	2,0	6,0	4,0	50
AF60140-025X	2,5	6,0	4,0	50
AF60140-030X	3,0	6,0	5,0	50
AF60140-035X	3,5	6,0	6,0	50
AF60140-040X	4,0	6,0	8,0	54
AF60140-045X	4,5	6,0	8,0	54
AF60140-050X	5,0	6,0	9,0	54
AF60140-060X	6,0	6,0	10,0	54
AF60140-070X	7,0	8,0	11,0	58
AF60140-080X	8,0	8,0	12,0	58
AF60140-090X	9,0	10,0	13,0	66
AF60140-100X	10,0	10,0	14,0	66
AF60140-120X	12,0	12,0	16,0	73
AF60140-140X	14,0	14,0	18,0	75
AF60140-160X	16,0	16,0	22,0	82
AF60140-180X	18,0	18,0	24,0	84
AF60140-200X	20,0	20,0	26,0	92

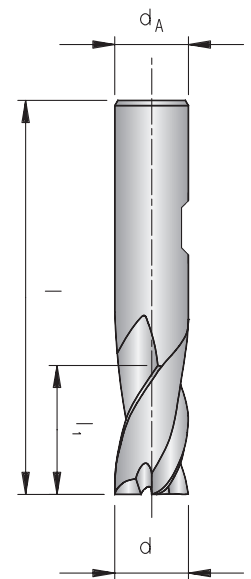

Toleranz / Tolerance	
Fräser / Mill	0 -0,03
Schaft / Shank	h6

● = Hauptanwendung / Main application
○ = Nebenanwendung / Suitable

Alle Angaben in mm / Dimensions in mm

VHM-Schaftfräser

4 Schneiden, lange Ausführung

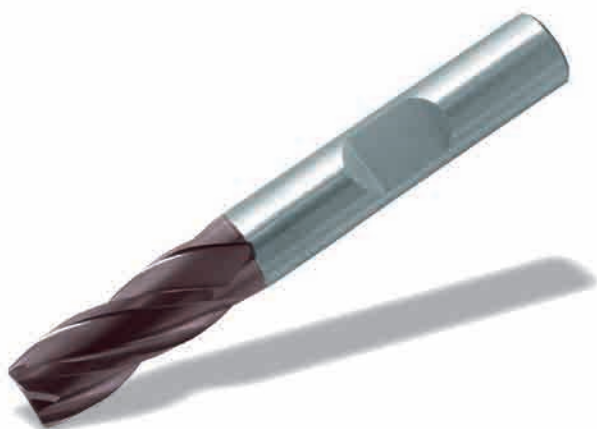

Solid carbide end-mill

4 flutes, long design

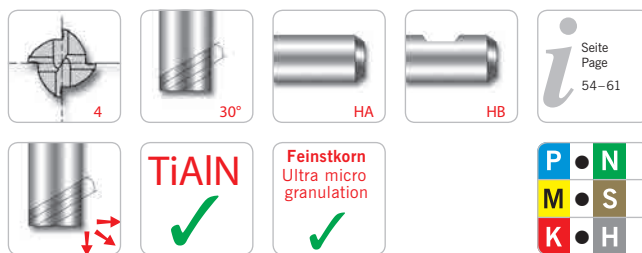

AF50141-... / AF60141-...

Schaft / Shank DIN 6535HA / HB	d	d _A	l ₁	l
AF50141-020*	2,0	3,0	7,0	38
AF60141-030	3,0	6,0	8,0	57
AF60141-035	3,5	6,0	10,0	57
AF60141-040	4,0	6,0	11,0	57
AF60141-045	4,5	6,0	11,0	57
AF60141-050	5,0	6,0	13,0	57
AF60141-060	6,0	6,0	13,0	57
AF60141-070	7,0	8,0	16,0	63
AF60141-080	8,0	8,0	19,0	63
AF60141-090	9,0	10,0	19,0	72
AF60141-100	10,0	10,0	22,0	72
AF60141-120	12,0	12,0	26,0	83
AF60141-140	14,0	14,0	26,0	83
AF60141-160	16,0	16,0	32,0	92
AF60141-180	18,0	18,0	32,0	92
AF60141-200	20,0	20,0	38,0	104

Toleranz / Tolerance	
Fräser / Mill	0 -0,03
Schaft / Shank	h6

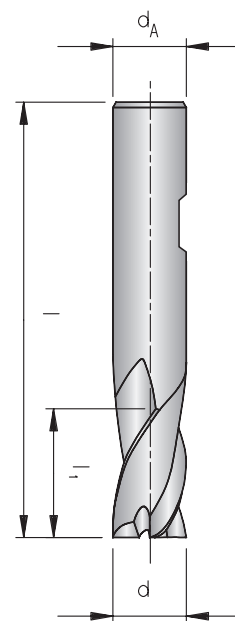

* Zylinderschaft nach DIN 6535HA ohne Mitnahmefläche

* Cylindrical shank to DIN 6535HA, no flat

● = Hauptanwendung / Main application
○ = Nebenanwendung / Suitable

Alle Angaben in mm / Dimensions in mm

VHM-Schaftfräser

4 Schneiden, lange Ausführung mit Eckenradius



Solid carbide end-mill

4 flutes, long design with corner radius

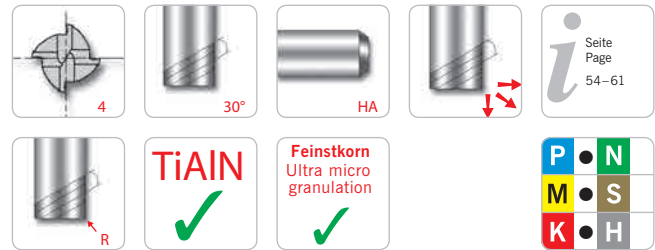

Seite
Page
54-61

AF50141-...R...

Schaft / Shank DIN 6535HA	d	d _A	l ₁	l	R
AF50141-030R0,5	3,0	4,0	6,0	75	0,50
AF50141-030R1,0	3,0	4,0	6,0	75	1,00
AF50141-040R0,5	4,0	4,0	8,0	75	0,50
AF50141-040R1,0	4,0	4,0	8,0	75	1,00
AF50141-050R0,5	5,0	6,0	10,0	75	0,50
AF50141-050R1,0	5,0	6,0	10,0	75	1,00
AF50141-060R0,5	6,0	6,0	12,0	75	0,50
AF50141-060R1,0	6,0	6,0	12,0	75	1,00
AF50141-080R0,5	8,0	8,0	16,0	100	0,50
AF50141-080R1,0	8,0	8,0	16,0	100	1,00
AF50141-080R1,5	8,0	8,0	16,0	100	1,50
AF50141-080R2,0	8,0	8,0	16,0	100	2,00
AF50141-080R2,5	8,0	8,0	16,0	100	2,50
AF50141-100R0,5	10,0	10,0	20,0	100	0,50
AF50141-100R1,0	10,0	10,0	20,0	100	1,00
AF50141-100R1,5	10,0	10,0	20,0	100	1,50
AF50141-100R2,0	10,0	10,0	20,0	100	2,00
AF50141-100R2,5	10,0	10,0	20,0	100	2,50
AF50141-120R0,5	12,0	12,0	24,0	100	0,50
AF50141-120R1,0	12,0	12,0	24,0	100	1,00
AF50141-120R1,5	12,0	12,0	24,0	100	1,50
AF50141-120R2,0	12,0	12,0	24,0	100	2,00
AF50141-120R2,5	12,0	12,0	24,0	100	2,50

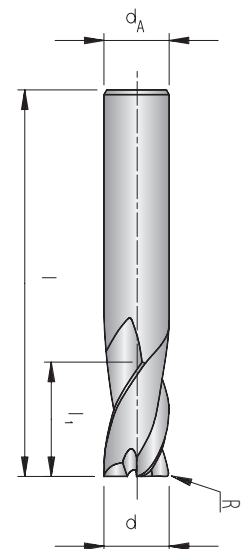

Toleranz / Tolerance	
Fräser / Mill	0 -0,03
Radius / Radius	± 0,03
Schaft / Shank	h6

● = Hauptanwendung / Main application
○ = Nebenanwendung / Suitable

Alle Angaben in mm / Dimensions in mm

VHM-Schaftfräser

4 Schneiden, extra lange Ausführung



Solid carbide end-mill

4 flutes, extra long design

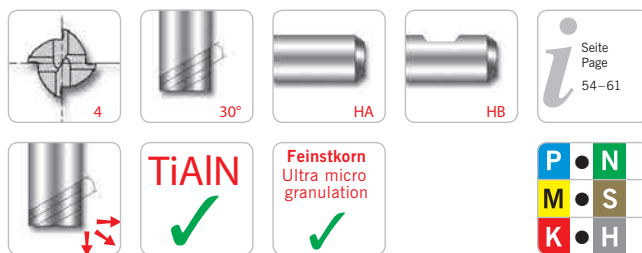

AF50142-...X / AF60142-...X

Schaft / Shank DIN 6535HA / HB	d	d _A	l ₁	l
AF50142-030X*	3,0	3,0	20,0	60
AF50142-040X*	4,0	4,0	20,0	60
AF50142-050X*	5,0	5,0	25,0	75
AF50142-060X*	6,0	6,0	30,0	75
AF50142-080X*	8,0	8,0	30,0	75
AF50142-100X*	10,0	10,0	40,0	100
AF50142-120X*	12,0	12,0	45,0	100
AF50142-140X*	14,0	14,0	45,0	100
AF50142-160X*	16,0	16,0	45,0	100
AF50142-180X*	18,0	18,0	45,0	100
AF50142-200X*	20,0	20,0	45,0	100
AF60142-060X ⓐ	6,0	6,0	30,0	75
AF60142-080X ⓐ	8,0	8,0	30,0	75
AF60142-100X ⓐ	10,0	10,0	40,0	100

Toleranz / Tolerance	
Fräser / Mill	0 -0,03
Schaft / Shank	h6

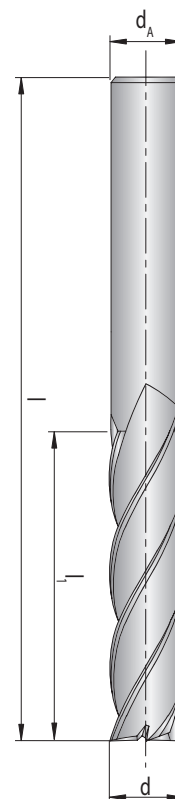

* Zylinderschaft nach DIN 6535HA ohne Mitnahmefläche

* Cylindrical shank to DIN 6535HA, no flat

● = Hauptanwendung / Main application
○ = Nebenanwendung / Suitable

Alle Angaben in mm / Dimensions in mm

VHM-Radiusfräser

4 Schneiden, kurze Ausführung

Solid carbide ball-nose end-mill

4 flutes, short design

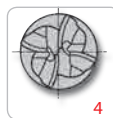
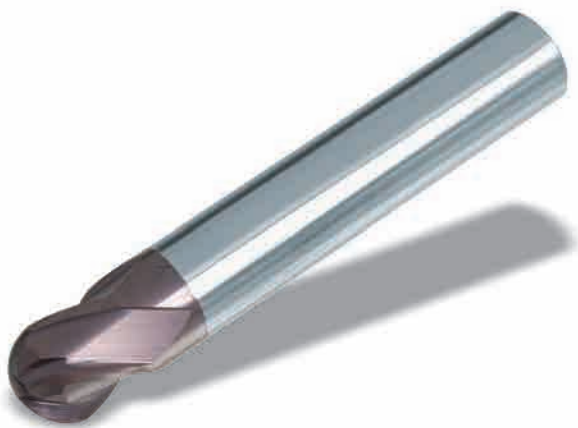

4



30°



HA

Seite
Page
54-61

TiAlN

Feinstkorn
Ultra micro
granulation

P	●	N
M		S ○
K	●	H

AF50340-...

Schaft / Shank DIN 6535HA	d	d _A	l ₁	l
AF50340-020	2,0	6,0	4,0	48
AF50340-030	3,0	6,0	4,0	48
AF50340-040	4,0	6,0	6,0	50
AF50340-050	5,0	6,0	7,0	51
AF50340-060	6,0	6,0	7,0	51
AF50340-080	8,0	8,0	9,0	59
AF50340-100	10,0	10,0	10,0	60
AF50340-120	12,0	12,0	14,0	71
AF50340-140	14,0	14,0	14,0	71
AF50340-160	16,0	16,0	16,0	76
AF50340-180	18,0	18,0	18,0	76
AF50340-200	20,0	20,0	20,0	82

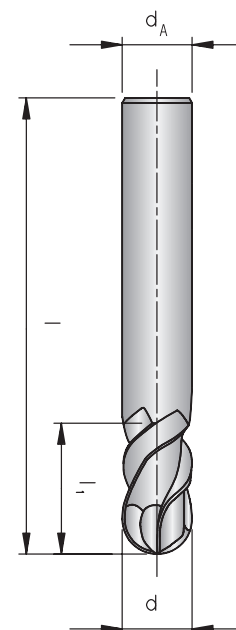

Toleranz / Tolerance

Fräser / Mill	0 -0,03
Radius / Radius	± 0,02
Schaft / Shank	h6

● = Hauptanwendung / Main application
○ = Nebenanwendung / Suitable

Alle Angaben in mm / Dimensions in mm

VHM-Schaftfräser

4 - 6 Schneiden, kurze Ausführung



Solid carbide end-mill

4 - 6 flutes, short design

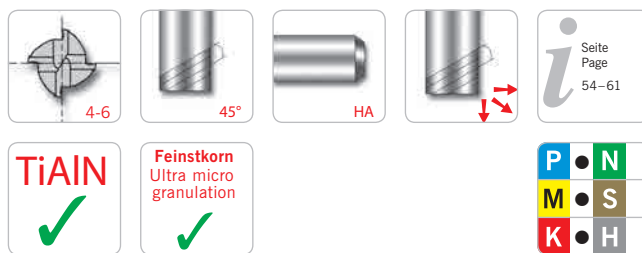

AF502.0-...

Schaft / Shank DIN 6535HA	d	d _A	l ₁	l	z
AF50240-030 N	3,0	4,0	8,0	50	4
AF50240-040 N	4,0	4,0	11,0	50	4
AF50260-050 N	5,0	6,0	13,0	50	6
AF50260-060 N	6,0	6,0	16,0	50	6
AF50260-080 N	8,0	8,0	19,0	60	6
AF50260-100 N	10,0	10,0	22,0	75	6
AF50260-120 N	12,0	12,0	26,0	75	6
AF50260-140 N	14,0	14,0	30,0	90	6
AF50260-160 N	16,0	16,0	32,0	100	6
AF50260-180 N	18,0	18,0	38,0	100	6
AF50260-200 N	20,0	20,0	38,0	100	6

Toleranz / Tolerance	
Fräser / Mill	0 -0,03
Schaft / Shank	h6

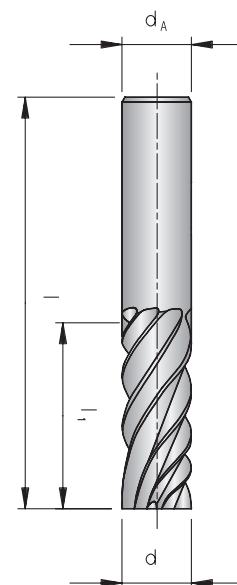

● = Hauptanwendung / Main application
○ = Nebenanwendung / Suitable

Alle Angaben in mm / Dimensions in mm

VHM-Schaftfräser

6 Schneiden, lange Ausführung

Solid carbide end-mill

6 flutes, long design



N NEU/NEW



6



45°



HA

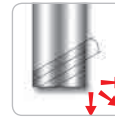

Seite
Page
54-61



TiAlN



Feinstkorn
Ultra micro
granulation



AF50261-...

Schaft / Shank DIN 6535HA	d	d _A	l ₁	l	z
AF50261-120 N	12,0	12,0	50,0	100	6
AF50261-160 N	16,0	16,0	65,0	150	6
AF50261-200 N	20,0	20,0	70,0	150	6

Toleranz / Tolerance	
Fräser / Mill	0 -0,03
Schaft / Shank	h6

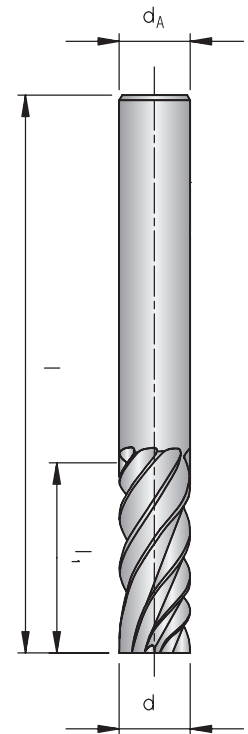

VHM-Schrupfräser

3 - 5 Schneiden, lange Ausführung

Solid carbide roughing end-mill

3 - 5 flutes, long design



3-5

30°

HB

Seite
Page
54-61

Grob / coarse

TiAlN

Feinstkorn
Ultra micro
granulation

P	●	N
M	●	S ○
K	●	H

AF614.1-....

Schaft / Shank DIN 6535HB	d h10	d _A h6	l ₁	l	z
AF61431-060	6,0	6,0	16,0	57	3
AF61431-080	8,0	8,0	16,0	63	3
AF61441-100	10,0	10,0	22,0	72	4
AF61441-120	12,0	12,0	26,0	83	4
AF61441-140	14,0	14,0	26,0	83	4
AF61441-160	16,0	16,0	32,0	92	4
AF61441-180	18,0	18,0	32,0	92	4
AF61441-200	20,0	20,0	38,0	104	4
AF61451-250	25,0	25,0	45,0	121	5

Toleranz / Tolerance (μm)	Nennwertbereich / Diameter range (mm)				
	≥ 1 - 3	> 3 - 6	> 6 - 10	> 10 - 18	> 18 - 30
h10	0 -40	0 -48	0 -58	0 -70	0 -84
h6	0 -6	0 -8	0 -9	0 -11	0 -13

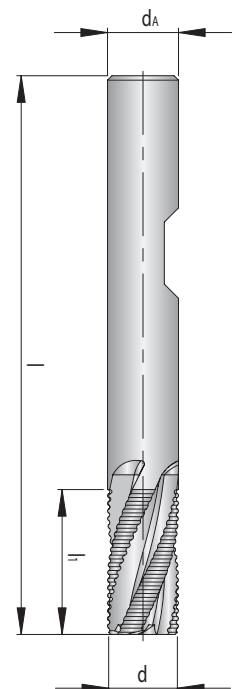

● = Hauptanwendung / Main application
○ = Nebenanwendung / Suitable

Alle Angaben in mm / Dimensions in mm

Empfohlene Schnittwerte VHM-Schafffräser

Ausführung AF

ISO	Werkstoff	Festigkeit [N/mm ²]	Vorschub- Korrektur- faktor [x f _z]	Schrupp- und Nutfräsen				Schlicht- und Konturfräsen			
				AlTiN V _c [m/min]	TiAlN V _c [m/min]	TiCN V _c [m/min]	Tia70 V _c [m/min]	AlTiN V _c [m/min]	TiAlN V _c [m/min]	TiCN V _c [m/min]	Tia70 V _c [m/min]
P	Allgemeiner Baustahl	< 800	1,2		100 - 150				200 - 240		
	Automatenstahl	< 800	1,2		100 - 150				200 - 240		
	Einsatzstahl, unlegiert	< 800	1,2		100 - 150				200 - 240		
	Einsatzstahl, legiert	< 1000	1		90 - 120				170 - 200		
	Vergütungsstahl, unlegiert	< 850	1,2		90 - 130				180 - 220		
	Vergütungsstahl, unlegiert	< 1000	1		60 - 90				100 - 140		
	Vergütungsstahl, legiert	< 800	1,2		90 - 120				170 - 200		
	Vergütungsstahl, legiert	< 1300	0,8		60 - 80				90 - 120		
	Stahlguss	< 850	1,2		70 - 100				150 - 180		
	Nitrierstahl	< 1000	1		90 - 90				100 - 140		
	Nitrierstahl	< 1200	0,8		60 - 80				90 - 120		
	Wälzlagerstahl	< 1200	0,8		60 - 90				100 - 140		
	Federstahl	< 1200	0,8		40 - 60				90 - 120		
	Schnellarbeitsstahl	< 1300	0,8		40 - 50				40 - 50		
Werkzeugstahl für Kaltarbeit	< 1300	0,8		60 - 70				90 - 110			
Werkzeugstahl für Warmarbeit	< 1300	0,8		60 - 70				90 - 110			
M	Stahl und Stahlguss, rostfrei geschwefelt	< 850	1		60 - 80				85 - 120		
	Nichtrostender Stahl, ferritisch	< 750	1		50 - 70				85 - 120		
	Nichtrostender Stahl, martensitisch	< 900	1		40 - 60				70 - 100		
	Nichtrostender Stahl, ferritisch/martensitisch	< 1100	0,9		30 - 40				60 - 80		
	Nichtrostender Stahl, austenitisch/ferritisch	< 850	1		50 - 70				80 - 120		
	Nichtrostender Stahl, austenitisch	< 750	1		60 - 80				80 - 120		
Hitzebeständig	< 1100	0,9		30 - 40				60 - 80			
K	Grauguss mit Lammellengraphit	100 - 350	1		80 - 100				140 - 160		
	Grauguss mit Lammellengraphit	300 - 1000	1		70 - 90				120 - 150		
	Kugelgraphitguss	300 - 500	1		80 - 100				140 - 160		
	Kugelgraphitguss	550 - 800	1		70 - 90				120 - 150		
	Temperguss, weiß	350 - 450	1		80 - 100				140 - 160		
	Temperguss, weiß	500 - 650	1		70 - 90				120 - 150		
	Temperguss, schwarz	350 - 450	1		80 - 100				140 - 160		
	Temperguss, schwarz	500 - 700	0,8		70 - 90				120 - 150		
N	Aluminium (unlegiert, niedrig legiert)	< 350									
	Aluminiumlegierungen < 0,5% Si	< 500									
	Aluminiumlegierungen 0,5 - 10% Si	< 400									
	Aluminiumlegierungen 10 - 15% Si	< 400									
	Aluminiumlegierungen > 15% Si	< 400									
	Kupfer (unlegiert, niedrig legiert)	< 350									
	Kupfer-Knetlegierungen	< 700									
	Kupfer-Sonderlegierungen	< 200 HB									
	Kupfer-Sonderlegierungen	< 300 HB									
	Kupfer-Sonderlegierungen	> 300 HB									
	Messing kurzspanend, Bronze, Rotguss	< 600									
	Messing langspanend	< 600									
	Thermoplaste										
	Duroplaste										
	Faserverstärkte Kunststoffe										
	Magnesium und Magnesiumlegierungen	< 850									
Graphit											
Wolfram und Wolframlegierungen											
Molybdän und Molybdänlegierungen											
S	Reinnickel										
	Nickellegierungen										
	Nickellegierungen	< 850									
	Nickel-Chromlegierungen										
	Nickel- und Kobaltlegierungen	< 1300									
	Hochwärmefeste Legierungen	< 1300									
	Nickel-Kobalt-(Chrom-)legierungen	< 1400									
	Nickel- und Kobaltlegierungen	< 1300									
	Reintitan	< 900									
Titanlegierungen	< 700										
Titanlegierungen	< 1200										
H	Stahl gehärtet	< 45 HRC									
		46 - 55 HRC									
		56 - 60 HRC									
		61 - 65 HRC									
		65 - 70 HRC									

Die Tabellenwerte sind Richtwerte. Es kann notwendig sein, die Werte den jeweiligen Bearbeitungsumständen anzupassen.

Recommended cutting data Solid carbide end-mill

Design AF

ISO	Material	Strength [N/mm ²]	Correction factor [x f _c]	Roughing and full slot milling				Peripheral- and contour milling					
				AlTiN	TiAlN	TiCN	Tia70	AlTiN	TiAlN	TiCN	Tia70		
				V _c [m/min]	V _c [m/min]	V _c [m/min]	V _c [m/min]	V _c [m/min]	V _c [m/min]	V _c [m/min]	V _c [m/min]		
P	General construction steel	< 800	1,2		100-150				200-240				
	Free cutting steel	< 800	1,2		100-150				200-240				
	Case hardened steel, non alloyed	< 800	1,2		100-150				200-240				
	Alloyed case hardened steel	< 1000	1		90-120				170-200				
	Tempering steel, non alloyed	< 850	1,2		90-130				180-220				
	Tempering steel, non alloyed	< 1000	1		60-90				100-140				
	Tempering steel, alloyed	< 800	1,2		90-120				170-200				
	Tempering steel, alloyed	< 1300	0,8		60-80				90-120				
	Steel castings	< 850	1,2		70-100				150-180				
	Nitriding steel	< 1000	1		90-90				100-140				
	Nitriding steel	< 1200	0,8		60-80				90-120				
	Roller bearing steel	< 1200	0,8		60-90				100-140				
	Spring steel	< 1200	0,8		40-60				90-120				
	High-speed steel	< 1300	0,8		40-50				40-50				
Cold working tool steel	< 1300	0,8		60-70				90-110					
Hot working tool steel	< 1300	0,8		60-70				90-110					
M	Steel and sulphured cast stainless steel	< 850	1		60-80				85-120				
	Stainless steel, ferritic	< 750	1		50-70				85-120				
	Stainless steel, martensitic	< 900	1		40-60				70-100				
	Stainless steel, ferritic/martensitic	< 1100	0,9		30-40				60-80				
	Stainless steel, austenitic/ferritic	< 850	1		50-70				80-120				
	Stainless steel, austenitic	< 750	1		60-80				80-120				
	Heat resistant steel	< 1100	0,9		30-40				60-80				
K	Grey cast iron with lamellar graphite	100-350	1		80-100				140-160				
	Grey cast iron with lamellar graphite	300-1000	1		70-90				120-150				
	Spheroidal cast iron	300-500	1		80-100				140-160				
	Spheroidal cast iron	550-800	1		70-90				120-150				
	White cast iron, tempered	350-450	1		80-100				140-160				
	White cast iron, tempered	500-650	1		70-90				120-150				
	Black cast iron, tempered	350-450	1		80-100				140-160				
	Black cast iron, tempered	500-700	0,8		70-90				120-150				
N	Aluminium (non alloyed, low alloyed)	< 350											
	Aluminium alloys < 0,5% Si	< 500											
	Aluminium alloys 0,5% - 10% Si	< 400											
	Aluminium alloys 10% - 15% Si	< 400											
	Aluminium alloys > 15% Si	< 400											
	Copper (non alloyed, low alloyed)	< 350											
	Copper wrought alloys	< 700											
	Special copper alloys	< 200 HB											
	Special copper alloys	< 300 HB											
	Special copper alloys	> 300 HB											
	Short-chipping brass, bronze, red bronze	< 600											
	Long-chipping brass	< 600											
	Thermoplastics												
	Duroplastics												
	Fibre-reinforced plastics												
	Magnesium and magnesium alloys	< 850											
Graphite													
Tungsten and tungsten alloys													
Molybdenum and molybdenum alloys													
S	Pure nickel												
	Nickel alloys												
	Nickel alloys	< 850											
	Nickel-chromium alloys												
	Nickel and cobalt alloys	< 1300											
	Nickel and cobalt alloys	< 1300											
	Heat resistant alloys	< 1400											
	Nickel-cobalt-chromium alloys	< 1300											
	Pure titanium	< 900											
Titanium alloys	< 700												
Titanium alloys	< 1200												
H	Tempered steel	< 45 HRC											
		46-55 HRC											
		56-60 HRC											
		61-65 HRC											
		65-70 HRC											

The recommended cutting data are only approximate values. It may be necessary to adjust them to each individual machining application.

Für die nachfolgenden Vorschub-Richtwerte müssen die Werte je nach zu bearbeitendem Material gemäß dem in den Schnittgeschwindigkeitstabellen angegebenen Korrekturfaktor $K_f [f_z]$ korrigiert werden.

For the following feed tables the values must be corrected depending on the material being machined in line with the correction factor $K_f [f_z]$.

Beispiel für Fräser mit Schneidendurchmesser 6 mm:

An example using a cutter with \varnothing 6 mm is detailed:

Schnittgeschwindigkeits-Tabelle / V_c -table

ISO	Werkstoff / Material	Festigkeit Strength [N/mm ² - HB]	K_f [x f_z]	TiAlN V_c [m/min]
P	Allgemeiner Baustahl General construction steel	< 800 N/mm ²	1,2	100 - 150
	Automatenstahl Free cutting steel	< 800 N/mm ²	1,2	100 - 150
	Einsatzstahl, unlegiert Case hardened steel, non alloyed	< 800 N/mm ²	1,2	100 - 150
	Einsatzstahl, legiert Alloyed case hardened steel	< 1000 N/mm ²	1	90 - 120
	Vergütungsstahl, unlegiert Tempering steel, non alloyed	< 850 N/mm ²	1,2	90 - 130
	Vergütungsstahl, unlegiert Tempering steel, non alloyed	< 1000 N/mm ²	1	60 - 90
	Vergütungsstahl, legiert Tempering steel, alloyed	< 800 N/mm ²	1,2	90 - 120
	Vergütungsstahl, legiert Tempering steel, alloyed	< 1300 N/mm ²	0,8	60 - 80
	Stahlguss Steel castings	< 850 N/mm ²	1,2	70 - 100

Korrekturfaktor-Tabelle / f_z -table

$\varnothing d_1$ [mm]	Korrekturfaktor/ Correction factor $K_f [f_z]$		
	1	0,7	0,8
1	0,004	0,003	0,003
2	0,008	0,006	0,006
3	0,012	0,008	0,010
4	0,016	0,011	0,013
5	0,020	0,014	0,016
6	0,024	0,017	0,019
8	0,032	0,022	0,026

Für legierten Einsatzstahl gilt der Vorschubwert aus der Korrekturfaktor-Tabelle.

$K_f (f_z) = 1$ (entsprechend 100%) $f_z = 0,024$

Für legierten Vergütungsstahl < 1300 N/mm² wird der Vorschubwert aus der Korrekturfaktor-Tabelle um 20% reduziert.

$K_f (f_z) = 0,8$ (entsprechend 80%) $f_z = 0,019$

For case-hardening alloy steel the feed value from the table is valid:

$K_f (f_z) = 1$ (according to 100%) $f_z = 0,024$

For heat treatable steel alloys < 1300 N/mm² the feed value from the table is reduced by 20%.

$K_f (f_z) = 0,8$ (according to 80%) $f_z = 0,019$

Generelle Berechnungsformeln / General rule:

Vorschub pro Zahn / Feed per tooth: $= f_z \cdot K_f (f_z)$

Bohrvorschub (Fräsen in axialer Richtung): = Tabellenwert / Zähnezahl

For axial plunge milling: = Table value / Number of teeth

Vorschub pro Zahn bei einer radialen Zustellung von 0,2 – 0,3 mm

Feed per tooth with radial depth of cut from 0,2 – 0,3 mm

Ø d ₁ [mm]	Korrekturfaktor / Correction factor Kf [f _z]									
	1	0,7	0,8	0,9	1,1	1,2	1,5	1,6	1,8	1,9
1	0,004	0,003	0,003	0,004	0,004	0,005	0,006	0,006	0,007	0,008
2	0,008	0,006	0,006	0,007	0,009	0,010	0,012	0,013	0,014	0,015
3	0,012	0,008	0,010	0,011	0,013	0,014	0,018	0,019	0,022	0,023
4	0,016	0,011	0,013	0,014	0,018	0,019	0,024	0,026	0,029	0,030
5	0,020	0,014	0,016	0,018	0,022	0,024	0,030	0,032	0,036	0,038
6	0,024	0,017	0,019	0,022	0,026	0,029	0,036	0,038	0,043	0,046
8	0,032	0,022	0,026	0,029	0,035	0,038	0,048	0,051	0,058	0,061
10	0,040	0,028	0,032	0,036	0,044	0,048	0,060	0,064	0,072	0,076
12	0,048	0,034	0,038	0,043	0,053	0,058	0,072	0,077	0,086	0,091
14	0,056	0,039	0,045	0,050	0,062	0,067	0,084	0,090	0,101	0,106
16	0,064	0,045	0,051	0,058	0,070	0,077	0,096	0,102	0,115	0,122
18	0,072	0,050	0,058	0,065	0,079	0,086	0,108	0,115	0,130	0,137
20	0,080	0,056	0,064	0,072	0,088	0,096	0,120	0,128	0,144	0,152
25	0,100	0,070	0,080	0,090	0,110	0,120	0,150	0,160	0,180	0,190

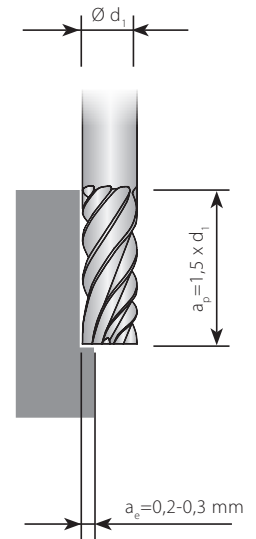

Vorschub pro Zahn bei einer radialen Zustellung 10% vom Schneidendurchmesser (Ø d₁)

Feed per tooth with radial depth of cut of 10% of the cutter (Ø d₁)

Ø d ₁ [mm]	Korrekturfaktor / Correction factor Kf [f _z]									
	1	0,7	0,8	0,9	1,1	1,2	1,5	1,6	1,8	1,9
1	0,003	0,002	0,002	0,003	0,003	0,004	0,005	0,005	0,005	0,006
2	0,008	0,006	0,006	0,007	0,009	0,010	0,012	0,013	0,014	0,015
3	0,012	0,008	0,010	0,011	0,013	0,014	0,018	0,019	0,022	0,023
4	0,014	0,010	0,011	0,013	0,015	0,017	0,021	0,022	0,025	0,027
5	0,017	0,012	0,014	0,015	0,019	0,020	0,026	0,027	0,031	0,032
6	0,020	0,014	0,016	0,018	0,022	0,024	0,030	0,032	0,036	0,038
8	0,027	0,019	0,022	0,024	0,030	0,032	0,041	0,043	0,049	0,051
10	0,033	0,023	0,026	0,030	0,036	0,040	0,050	0,053	0,059	0,063
12	0,040	0,028	0,032	0,036	0,044	0,048	0,060	0,064	0,072	0,076
14	0,047	0,033	0,038	0,042	0,052	0,056	0,071	0,075	0,085	0,089
16	0,053	0,037	0,042	0,048	0,058	0,064	0,080	0,085	0,095	0,101
18	0,060	0,042	0,048	0,054	0,066	0,072	0,090	0,096	0,108	0,114
20	0,067	0,047	0,054	0,060	0,074	0,080	0,101	0,107	0,121	0,127
25	0,083	0,058	0,066	0,075	0,091	0,100	0,125	0,133	0,149	0,158

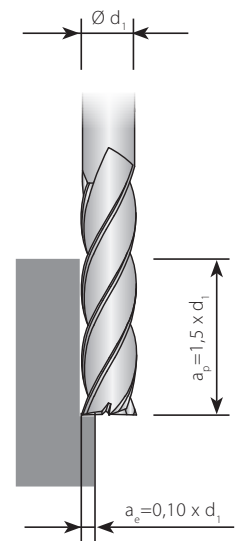

Achtung:

Vorschub-Korrekturfaktor → Kf f_z = 1,10 bei a_p = 1 x d₁ und → Kf f_z = 1,25 bei a_p = 0,5 x d₁
Für unbeschichtete Werkzeuge ist der Vorschub um 10-20% zu reduzieren.

Attention:

Feed rate correction factor → Kf f_z = 1,10 with a_p = 1 x d₁ and → Kf f_z = 1,25 with a_p = 0,5 x d₁
Feed rates are reduced by 10-20% for uncoated tools.

Vorschub pro Zahn bei einer radialen Zustellung 20% vom Schneidendurchmesser ($\varnothing d_1$)

Feed per tooth with radial depth of cut of 20% of the cutter ($\varnothing d_1$)

$\varnothing d_1$ [mm]	Korrekturfaktor / Correction factor $K_f [f_z]$									
	1	0,7	0,8	0,9	1,1	1,2	1,5	1,6	1,8	1,9
1	0,002	0,001	0,001	0,001	0,002	0,002	0,003	0,003	0,003	0,003
2	0,005	0,003	0,004	0,004	0,005	0,006	0,007	0,008	0,009	0,009
3	0,008	0,005	0,006	0,007	0,008	0,009	0,012	0,012	0,014	0,015
4	0,010	0,007	0,008	0,009	0,011	0,012	0,015	0,016	0,018	0,019
5	0,013	0,009	0,010	0,011	0,014	0,015	0,019	0,020	0,023	0,024
6	0,015	0,010	0,012	0,013	0,016	0,018	0,022	0,024	0,027	0,028
8	0,020	0,014	0,016	0,018	0,022	0,024	0,030	0,032	0,036	0,038
10	0,025	0,017	0,020	0,022	0,027	0,030	0,037	0,040	0,045	0,047
12	0,030	0,021	0,024	0,027	0,033	0,036	0,045	0,048	0,054	0,057
14	0,035	0,024	0,028	0,031	0,038	0,042	0,052	0,056	0,063	0,066
16	0,040	0,028	0,032	0,036	0,044	0,048	0,060	0,064	0,072	0,076
18	0,045	0,031	0,036	0,040	0,049	0,054	0,067	0,072	0,081	0,085
20	0,050	0,035	0,040	0,045	0,055	0,060	0,075	0,080	0,090	0,095
25	0,063	0,044	0,050	0,056	0,069	0,075	0,094	0,100	0,113	0,119

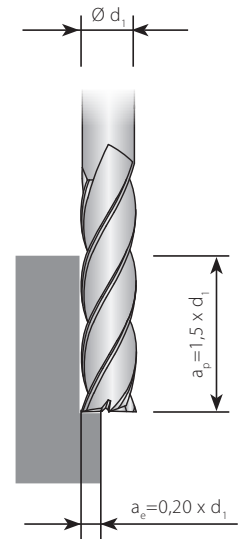

Vorschub pro Zahn bei einer radialen Zustellung 40% vom Schneidendurchmesser ($\varnothing d_1$)

Feed per tooth with radial depth of cut of 40% of the cutter ($\varnothing d_1$)

$\varnothing d_1$ [mm]	Korrekturfaktor / Correction factor $K_f [f_z]$									
	1	0,7	0,8	0,9	1,1	1,2	1,5	1,6	1,8	1,9
1	0,001	0,001	0,001	0,001	0,001	0,001	0,002	0,002	0,002	0,003
2	0,004	0,002	0,003	0,003	0,004	0,004	0,006	0,006	0,007	0,007
3	0,006	0,004	0,005	0,005	0,007	0,007	0,009	0,010	0,011	0,012
4	0,008	0,005	0,006	0,007	0,008	0,009	0,012	0,012	0,014	0,015
5	0,010	0,007	0,008	0,009	0,011	0,012	0,015	0,016	0,018	0,019
6	0,012	0,008	0,009	0,010	0,013	0,014	0,018	0,019	0,021	0,022
8	0,016	0,011	0,012	0,014	0,017	0,019	0,024	0,025	0,028	0,030
10	0,020	0,014	0,016	0,018	0,022	0,024	0,030	0,032	0,036	0,038
12	0,024	0,016	0,019	0,021	0,026	0,028	0,036	0,038	0,043	0,045
14	0,028	0,019	0,022	0,025	0,030	0,033	0,042	0,044	0,050	0,053
16	0,032	0,022	0,025	0,028	0,035	0,038	0,048	0,051	0,057	0,060
18	0,036	0,025	0,028	0,032	0,039	0,043	0,054	0,057	0,064	0,068
20	0,040	0,028	0,032	0,036	0,044	0,048	0,060	0,064	0,072	0,076
25	0,050	0,035	0,040	0,045	0,055	0,060	0,075	0,080	0,090	0,095

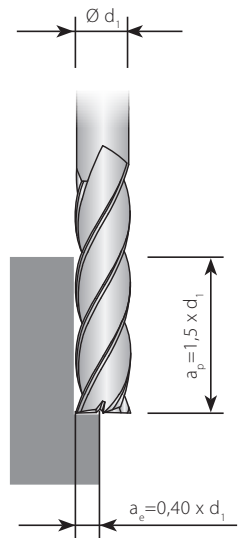

Achtung:
Vorschub-Korrekturfaktor $\rightarrow K_f f_z = 1,10$ bei $a_p = 1 \times d_1$ und $\rightarrow K_f f_z = 1,25$ bei $a_p = 0,5 \times d_1$
Für unbeschichtete Werkzeuge ist der Vorschub um 10-20% zu reduzieren.

Attention:
Feed rate correction factor $\rightarrow K_f f_z = 1,10$ with $a_p = 1 \times d_1$ and $\rightarrow K_f f_z = 1,25$ with $a_p = 0,5 \times d_1$
Feed rates are reduced by 10-20% for uncoated tools.

Vorschub pro Zahn bei einer radialen Zustellung 60% vom Schneidendurchmesser ($\varnothing d_1$)
 Feed per tooth with radial depth of cut of 60% of the cutter ($\varnothing d_1$)

$\varnothing d_1$ [mm]	Korrekturfaktor / Correction factor $K_f [f_z]$									
	1	0,7	0,8	0,9	1,1	1,2	1,5	1,6	1,8	1,9
1	0,001	0,001	0,001	0,001	0,001	0,001	0,001	0,002	0,002	0,002
2	0,003	0,002	0,002	0,002	0,003	0,003	0,004	0,005	0,005	0,006
3	0,005	0,003	0,004	0,004	0,005	0,006	0,007	0,008	0,009	0,009
4	0,006	0,004	0,005	0,005	0,007	0,007	0,009	0,010	0,011	0,012
5	0,008	0,005	0,006	0,007	0,009	0,010	0,012	0,013	0,015	0,016
6	0,009	0,006	0,007	0,008	0,010	0,011	0,014	0,015	0,017	0,018
8	0,013	0,009	0,010	0,011	0,014	0,015	0,019	0,020	0,023	0,024
10	0,016	0,011	0,013	0,014	0,017	0,019	0,024	0,026	0,029	0,030
12	0,019	0,013	0,015	0,017	0,021	0,023	0,029	0,031	0,035	0,037
14	0,022	0,015	0,018	0,020	0,025	0,027	0,034	0,036	0,040	0,043
16	0,026	0,018	0,020	0,023	0,028	0,031	0,039	0,041	0,046	0,049
18	0,029	0,020	0,023	0,026	0,032	0,035	0,043	0,046	0,052	0,055
20	0,032	0,022	0,026	0,029	0,035	0,039	0,048	0,052	0,058	0,061
25	0,040	0,028	0,032	0,036	0,045	0,049	0,061	0,065	0,073	0,077

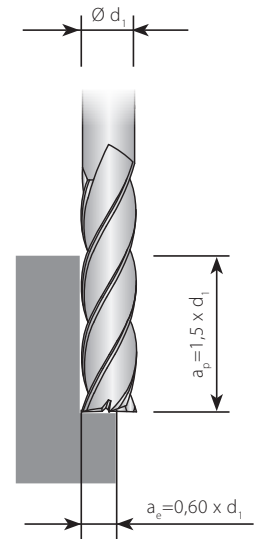

Vorschub pro Zahn bei einer radialen Zustellung 80% vom Schneidendurchmesser ($\varnothing d_1$)
 Feed per tooth with radial depth of cut of 80% of the cutter ($\varnothing d_1$)

$\varnothing d_1$ [mm]	Korrekturfaktor / Correction factor $K_f [f_z]$									
	1	0,7	0,8	0,9	1,1	1,2	1,5	1,6	1,8	1,9
1	0,001	0,001	0,001	0,001	0,001	0,001	0,001	0,001	0,001	0,001
2	0,002	0,001	0,002	0,002	0,002	0,003	0,003	0,004	0,004	0,004
3	0,004	0,002	0,003	0,003	0,004	0,004	0,006	0,006	0,007	0,007
4	0,005	0,003	0,004	0,004	0,005	0,006	0,007	0,008	0,009	0,009
5	0,006	0,004	0,005	0,005	0,007	0,007	0,009	0,010	0,011	0,012
6	0,007	0,005	0,006	0,006	0,008	0,009	0,011	0,012	0,013	0,014
8	0,010	0,007	0,008	0,009	0,011	0,012	0,015	0,016	0,018	0,019
10	0,012	0,008	0,010	0,011	0,013	0,015	0,018	0,020	0,022	0,023
12	0,015	0,010	0,012	0,013	0,016	0,018	0,022	0,024	0,027	0,028
14	0,017	0,012	0,014	0,015	0,019	0,021	0,026	0,028	0,031	0,033
16	0,020	0,014	0,016	0,018	0,022	0,024	0,030	0,032	0,036	0,038
18	0,022	0,015	0,018	0,020	0,024	0,027	0,033	0,036	0,040	0,042
20	0,025	0,017	0,020	0,022	0,027	0,030	0,037	0,040	0,045	0,047
25	0,031	0,022	0,025	0,028	0,034	0,037	0,047	0,050	0,056	0,059

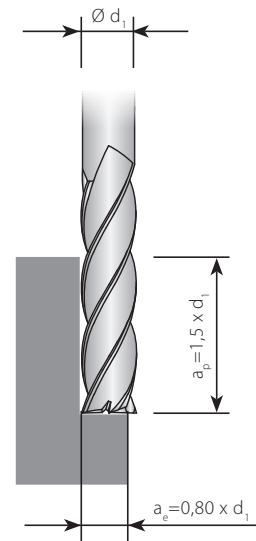

Achtung:
 Vorschub-Korrekturfaktor $\rightarrow K_f f_z = 1,10$ bei $a_p = 1 \times d_1$ und $\rightarrow K_f f_z = 1,25$ bei $a_p = 0,5 \times d_1$
 Für unbeschichtete Werkzeuge ist der Vorschub um 10-20% zu reduzieren.

Attention:
 Feed rate correction factor $\rightarrow K_f f_z = 1,10$ with $a_p = 1 \times d_1$ and $\rightarrow K_f f_z = 1,25$ with $a_p = 0,5 \times d_1$
 Feed rates are reduced by 10-20% for uncoated tools.

Vorschub pro Zahn beim Vollnutfräsen → $a_p = 0,5 \times d_1$

Feed per tooth when full slot milling → $a_p = 0,5 \times d_1$

Ø d ₁ [mm]	Korrekturfaktor / Correction factor Kf [f ₁]									
	1	0,7	0,8	0,9	1,1	1,2	1,5	1,6	1,8	1,9
1	0,002	0,001	0,001	0,001	0,002	0,002	0,003	0,003	0,003	0,003
2	0,004	0,002	0,003	0,003	0,004	0,004	0,006	0,006	0,007	0,007
3	0,007	0,004	0,005	0,006	0,007	0,008	0,010	0,011	0,012	0,013
4	0,009	0,006	0,007	0,008	0,009	0,010	0,013	0,014	0,016	0,017
5	0,011	0,007	0,008	0,009	0,012	0,013	0,016	0,017	0,019	0,020
6	0,013	0,009	0,010	0,011	0,014	0,015	0,019	0,020	0,023	0,024
8	0,018	0,012	0,014	0,016	0,019	0,021	0,027	0,028	0,032	0,034
10	0,022	0,015	0,017	0,019	0,024	0,026	0,033	0,035	0,039	0,041
12	0,030	0,021	0,024	0,027	0,033	0,036	0,045	0,048	0,054	0,057
14	0,032	0,022	0,025	0,028	0,035	0,038	0,048	0,051	0,057	0,060
16	0,036	0,025	0,028	0,032	0,039	0,043	0,054	0,057	0,064	0,068
18	0,042	0,029	0,033	0,037	0,046	0,050	0,063	0,067	0,075	0,079
20	0,045	0,031	0,036	0,040	0,049	0,054	0,067	0,072	0,081	0,085
25	0,056	0,039	0,044	0,050	0,061	0,067	0,084	0,089	0,100	0,106

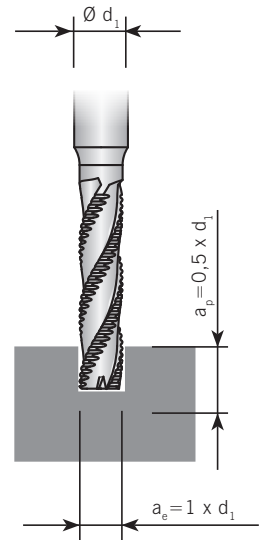

Vorschub pro Zahn beim Vollnutfräsen → $a_p = 1 \times d_1$

Feed per tooth when full slot milling → $a_p = 1 \times d_1$

Ø d ₁ [mm]	Korrekturfaktor / Correction factor Kf [f ₁]									
	1	0,7	0,8	0,9	1,1	1,2	1,5	1,6	1,8	1,9
1	0,001	0,001	0,001	0,001	0,001	0,002	0,002	0,002	0,002	0,002
2	0,003	0,002	0,002	0,002	0,003	0,003	0,004	0,004	0,005	0,005
3	0,005	0,003	0,004	0,004	0,005	0,005	0,007	0,007	0,008	0,009
4	0,006	0,004	0,005	0,005	0,006	0,007	0,009	0,009	0,011	0,011
5	0,007	0,005	0,006	0,006	0,008	0,009	0,011	0,011	0,013	0,014
6	0,008	0,006	0,007	0,008	0,009	0,010	0,013	0,014	0,015	0,016
8	0,012	0,008	0,009	0,011	0,013	0,014	0,018	0,019	0,021	0,022
10	0,014	0,010	0,011	0,013	0,016	0,017	0,021	0,023	0,026	0,027
12	0,020	0,014	0,016	0,018	0,021	0,023	0,029	0,031	0,035	0,037
14	0,021	0,015	0,017	0,019	0,023	0,025	0,031	0,033	0,037	0,040
16	0,023	0,016	0,019	0,021	0,026	0,028	0,035	0,037	0,042	0,044
18	0,027	0,019	0,022	0,025	0,030	0,033	0,041	0,044	0,049	0,052
20	0,029	0,020	0,023	0,026	0,032	0,035	0,044	0,047	0,053	0,056
25	0,036	0,025	0,029	0,033	0,040	0,044	0,055	0,058	0,066	0,069

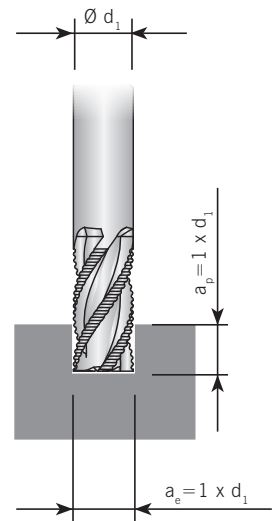

Achtung:
Für unbeschichtete Werkzeuge ist der Vorschub um 10-20% zu reduzieren.

Attention:
Feed rates are reduced by 10-20% for uncoated tools.

Alle Angaben in mm / Dimensions in mm

Vorschübe für Vollradius- und Torusfräser

Feed rates for ball nosed- and High feed cutters

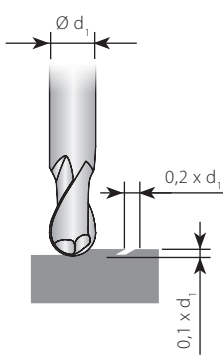
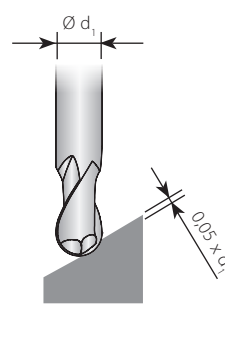
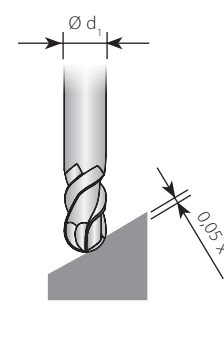
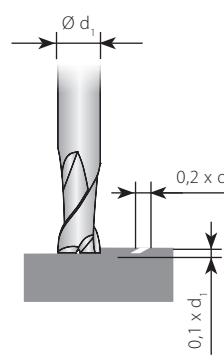
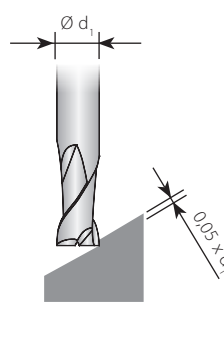
	Radiusfräser Ball nose end milling cutters	Radiusfräser Ball nose end milling cutters	Formenbau- Radiusfräser Ball nose cutter for mold and die production	Torusfräser Torus end milling cutters	Torusfräser Torus end milling cutters
					
d₁ [mm]	fz [mm]	fz [mm]	fz [mm]	fz [mm]	fz [mm]
2	0,015	0,010	0,005	0,010	0,015
3	0,030	0,020	0,015	0,015	0,020
4	0,040	0,030	0,030	0,020	0,030
5	0,060	0,050	0,050	0,030	0,040
6	0,070	0,060	0,060	0,050	0,060
8	0,100	0,080	0,070	0,070	0,080
10	0,120	0,100	0,080	0,080	0,100
12	0,150	0,120	0,090	0,100	0,120
16	0,180	0,150	0,100	0,120	0,150
18	0,200	0,180	0,110	0,140	0,160
20	0,220	0,200	0,120	0,150	0,180
25	0,240	0,220	0,140	0,160	0,200

Achtung:
Für unbeschichtete Werkzeuge ist der Vorschub um 10-20% zu reduzieren.

Attention:
Feed rates are reduced by 10-20% for uncoated tools.

Alle Angaben in mm / Dimensions in mm

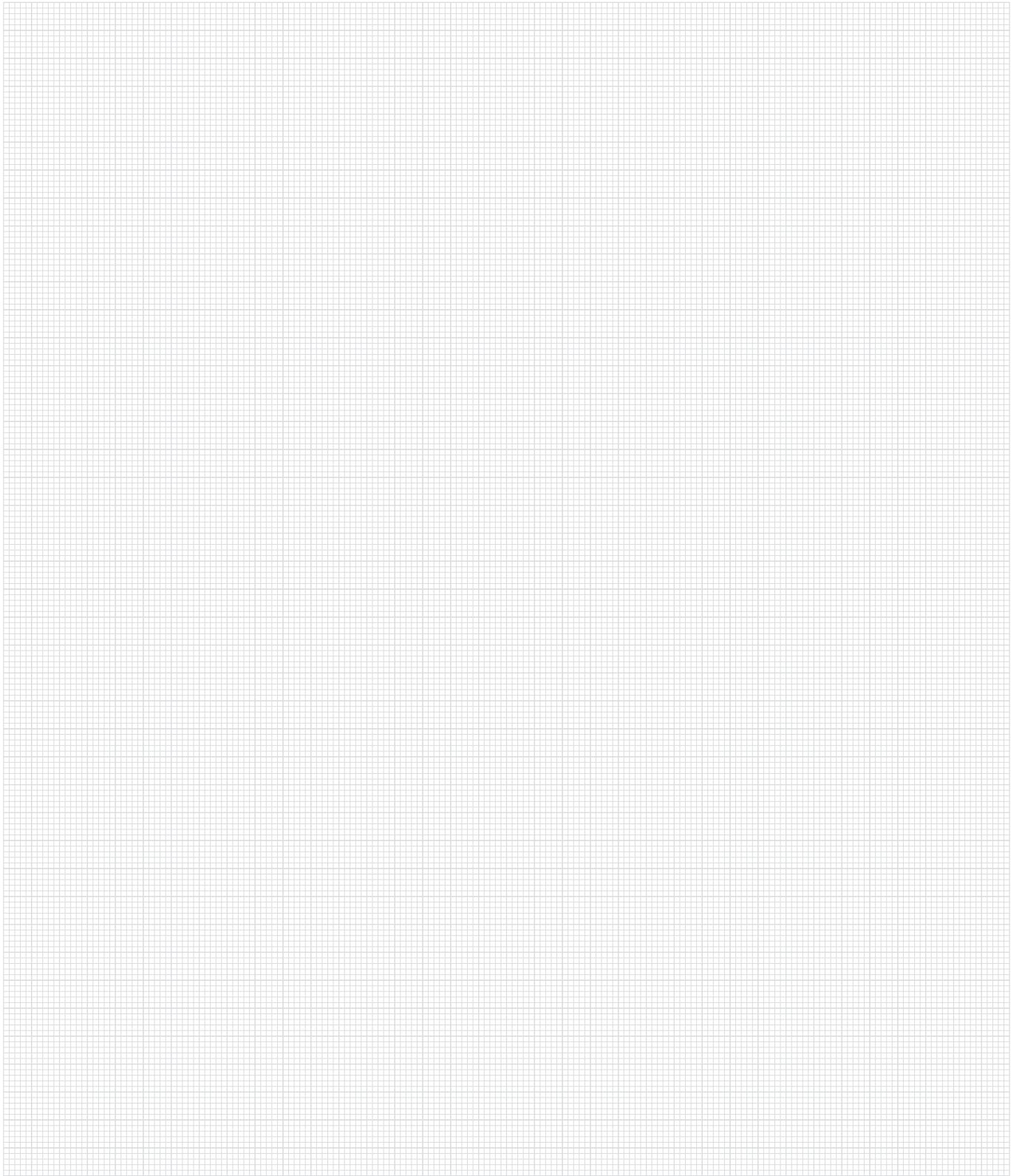

ARNO[®]
WERKZEUGE

Weitere Informationen finden Sie unter:
For more information see:

www.arno.de

ARNO[®]

WERKZEUGE

We have a passion for precision.

AUSFÜHRUNG AFJ

Design AFJ

Ideal für Exoten und rostfreie Stähle.

Ideal for exotics and stainless steel.

Spezielle Fräser zur Bearbeitung rostfreier Stähle und exotischer Materialien wie Titan, Inconel[®] oder Hastelloy[®] – auch für die HSC-Bearbeitung geeignet.

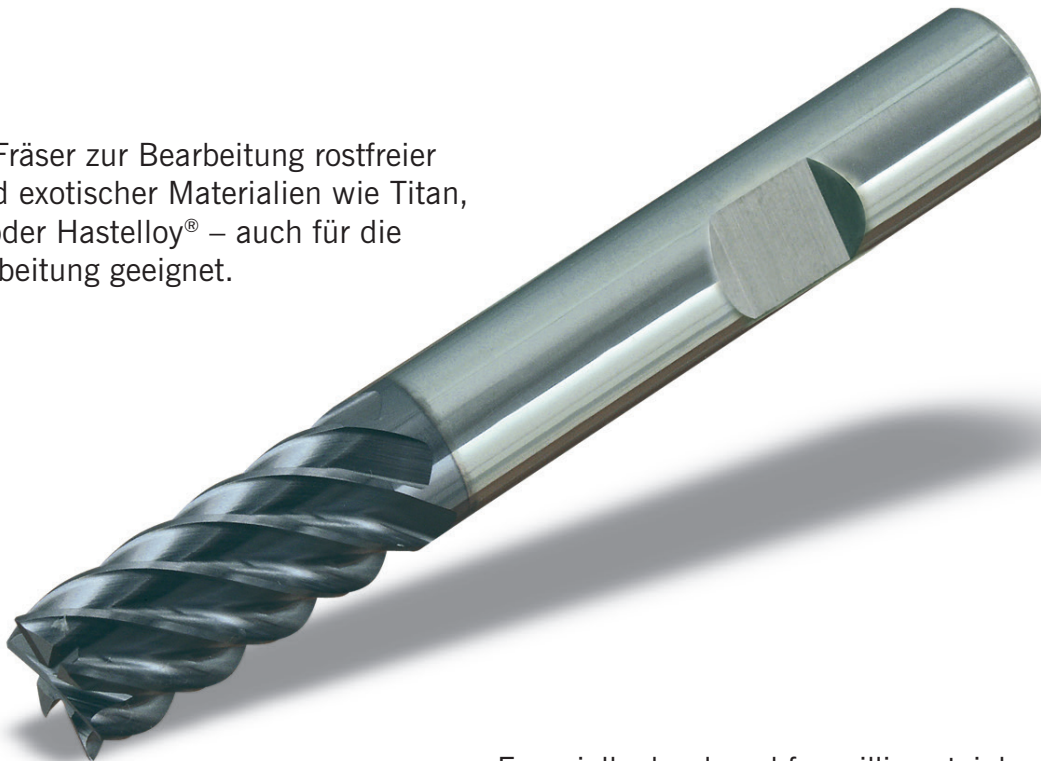

Especially developed for milling stainless steel and exotic materials such as titanium, Inconel[®] and Hastelloy[®]. Also suitable for high speed milling.

VHM-Schaftfräser

3 - 4 Schneiden, lange Ausführung

Solid carbide end-mill

3 - 4 flutes, long design

AFJ

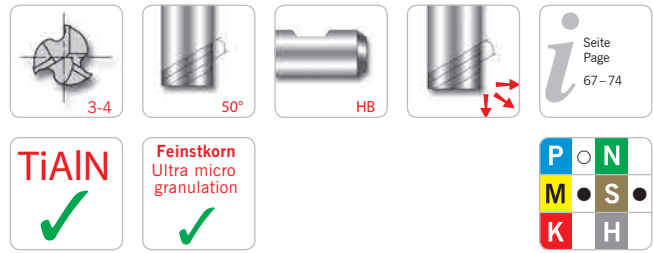

AFJ612.1-...

Schaft / Shank DIN 6535HB	d	d _A	l ₁	l	z
AFJ61231-030A N	3,0	6	8	52	3
AFJ61231-040A N	4,0	6	11	55	3
AFJ61231-050A N	5,0	6	13	57	3
AFJ61231-060	6,0	6	13	50	3
AFJ61231-060A N	6,0	6	13	57	3
AFJ61231-080	8,0	8	19	60	3
AFJ61231-080A N	8,0	8	19	63	3
AFJ61231-100	10,0	10	22	70	3
AFJ61231-100A N	10,0	10	22	72	3
AFJ61231-120	12,0	12	25	75	3
AFJ61231-120A N	12,0	12	25	83	3
AFJ61231-160	16,0	16	32	90	3
AFJ61231-160A N	16,0	16	32	92	3
AFJ61241-200	20,0	20	38	100	4
AFJ61241-200A N	20,0	20	38	104	4
AFJ61241-250	25,0	25	45	120	4
AFJ61241-250A N	25,0	25	45	121	4

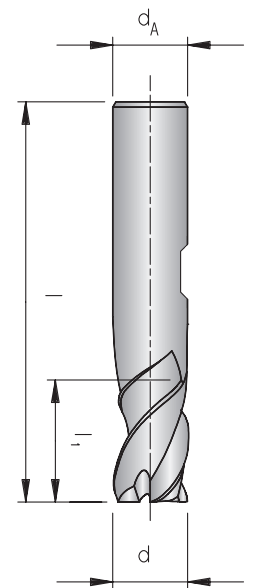

Toleranz / Tolerance	
Fräser / Mill	0 -0,03
Schaft / Shank	h6

● = Hauptanwendung / Main application
○ = Nebenanwendung / Suitable

Alle Angaben in mm / Dimensions in mm

VHM-Schaftfräser

4 - 8 Schneiden, kurze Ausführung



Solid carbide end-mill

4 - 8 flutes, short design

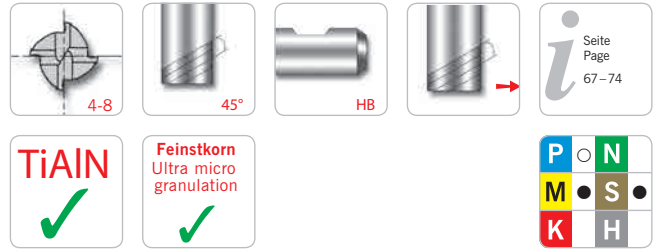

AFJ

AFJ602.0-...

Schaft / Shank DIN 6535HB	d	d _A	l ₁	l	z
AFJ60240-030 N	3,0	6	8	52	4
AFJ60240-040 N	4,0	6	11	55	4
AFJ60240-050 N	5,0	6	13	57	4
AFJ60260-060	6,0	6	13	57	6
AFJ60260-080	8,0	8	19	63	6
AFJ60260-100	10,0	10	22	72	6
AFJ60260-120	12,0	12	26	83	6
AFJ60260-140	14,0	14	26	83	6
AFJ60260-160	16,0	16	32	92	6
AFJ60280-200	20,0	20	38	104	8

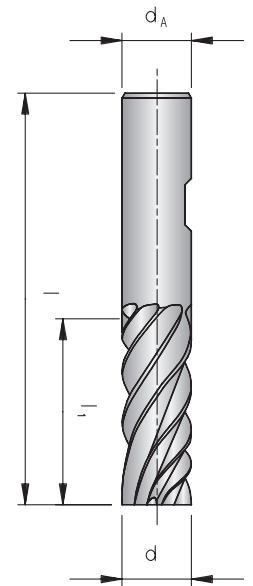

Toleranz / Tolerance	
Fräser / Mill	0 -0,03
Schaft / Shank	h6



SET-AFJ60260 TiAlN

SET-Inhalt SET, contains [Stück / Pcs.]	Schaft Shank	d	d _A	l ₁	l	z
2x -->	AFJ60260-060	6,0	6	13	57	6
2x -->	AFJ60260-080	8,0	8	19	63	6
2x -->	AFJ60260-100	10,0	10	22	72	6
2x -->	AFJ60260-120	12,0	12	26	83	6

Bestellbezeichnung / Ordering description: SET-AFJ60260 TiAlN

● = Hauptanwendung / Main application
○ = Nebenanwendung / Suitable

Alle Angaben in mm / Dimensions in mm

VHM-Schrupfräser

3 - 6 Schneiden, lange Ausführung

Solid carbide roughing end-mill

3 - 6 flutes, long design

AFJ

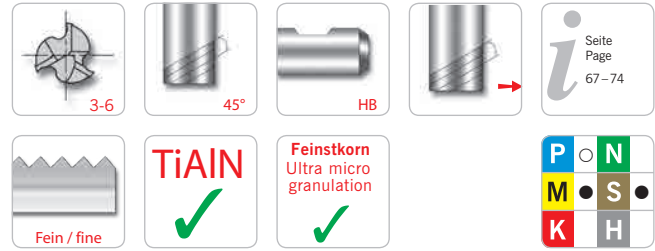

AFJ619.1-...

Schaft / Shank DIN 6535HB	d h10	d _A h6	l ₁	l	z
AFJ61931-040	4,0	6	11	57	3
AFJ61941-050	5,0	6	13	57	4
AFJ61941-060	6,0	6	16	57	4
AFJ61941-080	8,0	8	16	63	4
AFJ61941-100	10,0	10	22	72	4
AFJ61941-120	12,0	12	26	83	4
AFJ61941-140	14,0	14	26	83	4
AFJ61951-160	16,0	16	32	92	5
AFJ61961-200	20,0	20	38	104	6
AFJ61961-250	25,0	25	45	121	6

Toleranz / Tolerance (μm)	Nennwertbereich / Diameter range (mm)				
	≥ 1 - 3	> 3 - 6	> 6 - 10	> 10 - 18	> 18 - 30
h10	0 -40	0 -48	0 -58	0 -70	0 -84
h6	0 -6	0 -8	0 -9	0 -11	0 -13

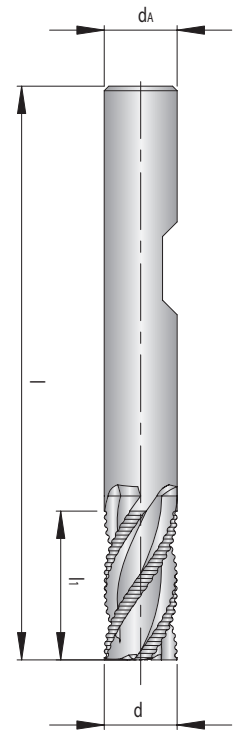

Empfohlene Schnittwerte VHM-Schafffräser

Ausführung AFJ

AFJ

ISO	Werkstoff	Festigkeit [N/mm²]	Vorschub-Korrekturfaktor [$\times f_z$]	Schrupp- und Nutfräsen				Schlicht- und Konturfräsen			
				AlTiN <small>V_c [m/min]</small>	TiAlN <small>V_c [m/min]</small>	TiCN <small>V_c [m/min]</small>	Tia70 <small>V_c [m/min]</small>	AlTiN <small>V_c [m/min]</small>	TiAlN <small>V_c [m/min]</small>	TiCN <small>V_c [m/min]</small>	Tia70 <small>V_c [m/min]</small>
P	Allgemeiner Baustahl	< 800									
	Automatenstahl	< 800									
	Einsatzstahl, unlegiert	< 800									
	Einsatzstahl, legiert	< 1000									
	Vergütungsstahl, unlegiert	< 850									
	Vergütungsstahl, unlegiert	< 1000									
	Vergütungsstahl, legiert	< 800									
	Vergütungsstahl, legiert	< 1300									
	Stahlguss	< 850									
	Nitrierstahl	< 1000									
	Nitrierstahl	< 1200									
	Wälzlagerstahl	< 1200									
	Federstahl	< 1200									
	Schnellarbeitsstahl	< 1300									
	Werkzeugstahl für Kaltarbeit	< 1300									
Werkzeugstahl für Warmarbeit	< 1300										
M	Stahl und Stahlguss, rostfrei geschwefelt	< 850	1	60-80	60-80			85-120	85-120		
	Nichtrostender Stahl, ferritisch	< 750	1	50-70	50-70			85-120	85-120		
	Nichtrostender Stahl, martensitisch	< 900	1	40-60	40-60			70-100	70-100		
	Nichtrostender Stahl, ferritisch/martensitisch	< 1100	0,9	30-40	30-40			60-80	60-80		
	Nichtrostender Stahl, austenitisch/ferritisch	< 850	1	50-70	50-70			80-120	80-120		
	Nichtrostender Stahl, austenitisch	< 750	1	60-80	60-80			80-120	80-120		
K	Hitzebeständig	< 1100	0,9	30-40	30-40			60-80	60-80		
	Grauguss mit Lammellengraphit	100-350									
	Grauguss mit Lammellengraphit	300-1000									
	Kugelgraphitguss	300-500									
	Kugelgraphitguss	550-800									
	Temperguss, weiß	350-450									
	Temperguss, weiß	500-650									
	Temperguss, schwarz	350-450									
Temperguss, schwarz	500-700										
N	Aluminium (unlegiert, niedrig legiert)	< 350									
	Aluminiumlegierungen < 0,5% Si	< 500									
	Aluminiumlegierungen 0,5 - 10% Si	< 400									
	Aluminiumlegierungen 10 - 15% Si	< 400									
	Aluminiumlegierungen > 15% Si	< 400									
	Kupfer (unlegiert, niedrig legiert)	< 350									
	Kupfer-Knetlegierungen	< 700									
	Kupfer-Sonderlegierungen	< 200 HB									
	Kupfer-Sonderlegierungen	< 300 HB									
	Kupfer-Sonderlegierungen	> 300 HB									
	Messing kurzspanend, Bronze, Rotguss	< 600									
	Messing langspanend	< 600									
	Thermoplaste										
	Duroplaste										
	Faserverstärkte Kunststoffe										
	Magnesium und Magnesiumlegierungen	< 850									
S	Graphit										
	Wolfram und Wolframlegierungen										
	Molybdän und Molybdänlegierungen										
	Reinnickel		1,1	40-60	40-50			70-100	60-90		
	Nickellegierungen		1	30-50	30-40			50-80	40-70		
	Nickellegierungen	< 850	1,1	60-80	50-70			70-110	70-100		
	Nickel-Chromlegierungen		0,9	50-70	40-60			60-100	60-90		
	Nickel- und Kobaltlegierungen	< 1300	0,7	40-60	30-50			50-90	50-80		
	Hochwarmfeste Legierungen	< 1300	0,7	40-60	30-50			60-100	60-90		
	Nickel-Kobalt-(Chrom-)legierungen	< 1400	0,9	30-50	30-40			50-80	50-70		
	Nickel- und Kobaltlegierungen	< 1300	1	40-60	30-50			50-80	50-70		
	Reintitan	< 900	1	60-80	50-70			90-130	90-120		
Titanlegierungen	< 700	1,1	70-90	60-80			100-140	100-130			
Titanlegierungen	< 1200	1	50-60	40-50			90-120	90-110			
H	Stahl gehärtet	< 45 HRC									
		46-55 HRC									
		56-60 HRC									
		61-65 HRC									
		65-70 HRC									

Die Tabellenwerte sind Richtwerte. Es kann notwendig sein, die Werte den jeweiligen Bearbeitungsumständen anzupassen.

Recommended cutting data Solid carbide end-mill

Design AFJ

AFJ

ISO	Material	Strength [N/mm ²]	Correction factor [x f _z]	Roughing and full slot milling				Peripheral- and contour milling					
				AlTiN V _c [m/min]	TiAlN V _c [m/min]	TiCN V _c [m/min]	Tia70 V _c [m/min]	AlTiN V _c [m/min]	TiAlN V _c [m/min]	TiCN V _c [m/min]	Tia70 V _c [m/min]		
P	General construction steel	< 800											
	Free cutting steel	< 800											
	Case hardened steel, non alloyed	< 800											
	Alloyed case hardened steel	< 1000											
	Tempering steel, non alloyed	< 850											
	Tempering steel, non alloyed	< 1000											
	Tempering steel, alloyed	< 800											
	Tempering steel, alloyed	< 1300											
	Steel castings	< 850											
	Nitriding steel	< 1000											
	Nitriding steel	< 1200											
	Roller bearing steel	< 1200											
	Spring steel	< 1200											
	High-speed steel	< 1300											
Cold working tool steel	< 1300												
Hot working tool steel	< 1300												
M	Steel and sulphured cast stainless steel	< 850	1	60-80	60-80			85-120	85-120				
	Stainless steel, ferritic	< 750	1	50-70	50-70			85-120	85-120				
	Stainless steel, martensitic	< 900	1	40-60	40-60			70-100	70-100				
	Stainless steel, ferritic/martensitic	< 1100	0,9	30-40	30-40			60-80	60-80				
	Stainless steel, austenitic/ferritic	< 850	1	50-70	50-70			80-120	80-120				
	Stainless steel, austenitic	< 750	1	60-80	60-80			80-120	80-120				
Heat resistant steel	< 1100	0,9	30-40	30-40			60-80	60-80					
K	Grey cast iron with lamellar graphite	100-350											
	Grey cast iron with lamellar graphite	300-1000											
	Spheroidal cast iron	300-500											
	Spheroidal cast iron	550-800											
	White cast iron, tempered	350-450											
	White cast iron, tempered	500-650											
	Black cast iron, tempered	350-450											
	Black cast iron, tempered	500-700											
N	Aluminium (non alloyed, low alloyed)	< 350											
	Aluminium alloys < 0,5% Si	< 500											
	Aluminium alloys 0,5% - 10% Si	< 400											
	Aluminium alloys 10% - 15% Si	< 400											
	Aluminium alloys > 15% Si	< 400											
	Copper (non alloyed, low alloyed)	< 350											
	Copper wrought alloys	< 700											
	Special copper alloys	< 200 HB											
	Special copper alloys	< 300 HB											
	Special copper alloys	> 300 HB											
	Short-chipping brass, bronze, red bronze	< 600											
	Long-chipping brass	< 600											
	Thermoplastics												
	Duroplastics												
	Fibre-reinforced plastics												
	Magnesium and magnesium alloys	< 850											
Graphite													
Tungsten and tungsten alloys													
Molybdenum and molybdenum alloys													
S	Pure nickel		1,1	40-60	40-50			70-100	60-90				
	Nickel alloys		1	30-50	30-40			50-80	40-70				
	Nickel alloys	< 850	1,1	60-80	50-70			70-110	70-100				
	Nickel-chromium alloys		0,9	50-70	40-60			60-100	60-90				
	Nickel and cobalt alloys	< 1300	0,7	40-60	30-50			50-90	50-80				
	Nickel and cobalt alloys	< 1300	0,7	40-60	30-50			60-100	60-90				
	Heat resistant alloys	< 1400	0,9	30-50	30-40			50-80	50-70				
	Nickel-cobalt-chromium alloys	< 1300	1	40-60	30-50			50-80	50-70				
	Pure titanium	< 900	1	60-80	50-70			90-130	90-120				
	Titanium alloys	< 700	1,1	70-90	60-80			100-140	100-130				
Titanium alloys	< 1200	1	50-60	40-50			90-120	90-110					
H	Tempered steel	< 45 HRC											
		46-55 HRC											
		56-60 HRC											
		61-65 HRC											
		65-70 HRC											

The recommended cutting data are only approximate values. It may be necessary to adjust them to each individual machining application.

Für die nachfolgenden Vorschub-Richtwerte müssen die Werte je nach zu bearbeitendem Material gemäß dem in den Schnittgeschwindigkeitstabellen angegebenen Korrekturfaktor $K_f [f_z]$ korrigiert werden.

For the following feed tables the values must be corrected depending on the material being machined in line with the correction factor $K_f [f_z]$.

Beispiel für Fräser mit Schneidendurchmesser 6 mm:

An example using a cutter with \varnothing 6 mm is detailed:

Schnittgeschwindigkeits-Tabelle / V_c -table

ISO	Werkstoff / Material	Festigkeit Strength [N/mm ² - HB]	$K_f [x f_z]$	TiAlN V_c [m/min]
P	Allgemeiner Baustahl General construction steel	< 800 N/mm ²	1,2	100 - 150
	Automatenstahl Free cutting steel	< 800 N/mm ²	1,2	100 - 150
	Einsatzstahl, unlegiert Case hardened steel, non alloyed	< 800 N/mm ²	1,2	100 - 150
	Einsatzstahl, legiert Alloyed case hardened steel	< 1000 N/mm ²	1	90 - 120
	Vergütungsstahl, unlegiert Tempering steel, non alloyed	< 850 N/mm ²	1,2	90 - 130
	Vergütungsstahl, unlegiert Tempering steel, non alloyed	< 1000 N/mm ²	1	60 - 90
	Vergütungsstahl, legiert Tempering steel, alloyed	< 800 N/mm ²	1,2	90 - 120
	Vergütungsstahl, legiert Tempering steel, alloyed	< 1300 N/mm ²	0,8	60 - 80
	Stahlguss Steel castings	< 850 N/mm ²	1,2	70 - 100

Korrekturfaktor-Tabelle / f_z -table

$\varnothing d_1$ [mm]	Korrekturfaktor/ Correction factor $K_f [f_z]$		
	1	0,7	0,8
1	0,004	0,003	0,003
2	0,008	0,006	0,006
3	0,012	0,008	0,010
4	0,016	0,011	0,013
5	0,020	0,014	0,016
6	0,024	0,017	0,019
8	0,032	0,022	0,026

Für legierten Einsatzstahl gilt der Vorschubwert aus der Korrekturfaktor-Tabelle.

$K_f (f_z) = 1$ (entsprechend 100%) $f_z = 0,024$

Für legierten Vergütungsstahl < 1300 N/mm² wird der Vorschubwert aus der Korrekturfaktor-Tabelle um 20% reduziert.

$K_f (f_z) = 0,8$ (entsprechend 80%) $f_z = 0,019$

For case-hardening alloy steel the feed value from the table is valid:

$K_f (f_z) = 1$ (according to 100%) $f_z = 0,024$

For heat treatable steel alloys < 1300 N/mm² the feed value from the table is reduced by 20%.

$K_f (f_z) = 0,8$ (according to 80%) $f_z = 0,019$

Generelle Berechnungsformeln / General rule:

Vorschub pro Zahn / Feed per tooth: $= f_z \cdot K_f (f_z)$

Bohrvorschub (Fräsen in axialer Richtung): $= \text{Tabellenwert} / \text{Zähnezahl}$

For axial plunge milling: $= \text{Table value} / \text{Number of teeth}$

Vorschub pro Zahn bei einer radialen Zustellung von 0,2 – 0,3 mm

Feed per tooth with radial depth of cut from 0,2 – 0,3 mm

Ø d ₁ [mm]	Korrekturfaktor / Correction factor Kf [f _z]									
	1	0,7	0,8	0,9	1,1	1,2	1,5	1,6	1,8	1,9
1	0,004	0,003	0,003	0,004	0,004	0,005	0,006	0,006	0,007	0,008
2	0,008	0,006	0,006	0,007	0,009	0,010	0,012	0,013	0,014	0,015
3	0,012	0,008	0,010	0,011	0,013	0,014	0,018	0,019	0,022	0,023
4	0,016	0,011	0,013	0,014	0,018	0,019	0,024	0,026	0,029	0,030
5	0,020	0,014	0,016	0,018	0,022	0,024	0,030	0,032	0,036	0,038
6	0,024	0,017	0,019	0,022	0,026	0,029	0,036	0,038	0,043	0,046
8	0,032	0,022	0,026	0,029	0,035	0,038	0,048	0,051	0,058	0,061
10	0,040	0,028	0,032	0,036	0,044	0,048	0,060	0,064	0,072	0,076
12	0,048	0,034	0,038	0,043	0,053	0,058	0,072	0,077	0,086	0,091
14	0,056	0,039	0,045	0,050	0,062	0,067	0,084	0,090	0,101	0,106
16	0,064	0,045	0,051	0,058	0,070	0,077	0,096	0,102	0,115	0,122
18	0,072	0,050	0,058	0,065	0,079	0,086	0,108	0,115	0,130	0,137
20	0,080	0,056	0,064	0,072	0,088	0,096	0,120	0,128	0,144	0,152
25	0,100	0,070	0,080	0,090	0,110	0,120	0,150	0,160	0,180	0,190

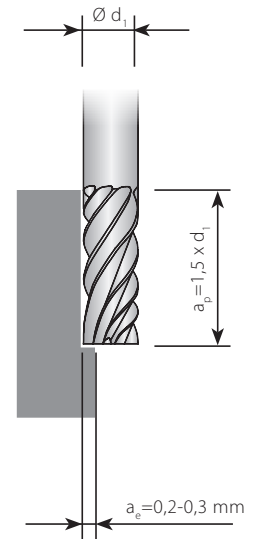

Vorschub pro Zahn bei einer radialen Zustellung 10% vom Schneidendurchmesser (Ø d₁)

Feed per tooth with radial depth of cut of 10% of the cutter (Ø d₁)

Ø d ₁ [mm]	Korrekturfaktor / Correction factor Kf [f _z]									
	1	0,7	0,8	0,9	1,1	1,2	1,5	1,6	1,8	1,9
1	0,003	0,002	0,002	0,003	0,003	0,004	0,005	0,005	0,005	0,006
2	0,008	0,006	0,006	0,007	0,009	0,010	0,012	0,013	0,014	0,015
3	0,012	0,008	0,010	0,011	0,013	0,014	0,018	0,019	0,022	0,023
4	0,014	0,010	0,011	0,013	0,015	0,017	0,021	0,022	0,025	0,027
5	0,017	0,012	0,014	0,015	0,019	0,020	0,026	0,027	0,031	0,032
6	0,020	0,014	0,016	0,018	0,022	0,024	0,030	0,032	0,036	0,038
8	0,027	0,019	0,022	0,024	0,030	0,032	0,041	0,043	0,049	0,051
10	0,033	0,023	0,026	0,030	0,036	0,040	0,050	0,053	0,059	0,063
12	0,040	0,028	0,032	0,036	0,044	0,048	0,060	0,064	0,072	0,076
14	0,047	0,033	0,038	0,042	0,052	0,056	0,071	0,075	0,085	0,089
16	0,053	0,037	0,042	0,048	0,058	0,064	0,080	0,085	0,095	0,101
18	0,060	0,042	0,048	0,054	0,066	0,072	0,090	0,096	0,108	0,114
20	0,067	0,047	0,054	0,060	0,074	0,080	0,101	0,107	0,121	0,127
25	0,083	0,058	0,066	0,075	0,091	0,100	0,125	0,133	0,149	0,158

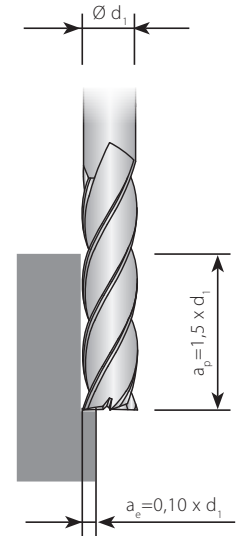

Achtung:
Vorschub-Korrekturfaktor → Kf f_z = 1,10 bei a_p = 1 x d₁ und → Kf f_z = 1,25 bei a_p = 0,5 x d₁
Für unbeschichtete Werkzeuge ist der Vorschub um 10-20% zu reduzieren.

Attention:
Feed rate correction factor → Kf f_z = 1,10 with a_p = 1 x d₁ and → Kf f_z = 1,25 with a_p = 0,5 x d₁
Feed rates are reduced by 10-20% for uncoated tools.

Vorschub pro Zahn bei einer radialen Zustellung 20% vom Schneidendurchmesser ($\varnothing d_1$)
 Feed per tooth with radial depth of cut of 20% of the cutter ($\varnothing d_1$)

$\varnothing d_1$ [mm]	Korrekturfaktor / Correction factor $K_f [f_z]$									
	1	0,7	0,8	0,9	1,1	1,2	1,5	1,6	1,8	1,9
1	0,002	0,001	0,001	0,001	0,002	0,002	0,003	0,003	0,003	0,003
2	0,005	0,003	0,004	0,004	0,005	0,006	0,007	0,008	0,009	0,009
3	0,008	0,005	0,006	0,007	0,008	0,009	0,012	0,012	0,014	0,015
4	0,010	0,007	0,008	0,009	0,011	0,012	0,015	0,016	0,018	0,019
5	0,013	0,009	0,010	0,011	0,014	0,015	0,019	0,020	0,023	0,024
6	0,015	0,010	0,012	0,013	0,016	0,018	0,022	0,024	0,027	0,028
8	0,020	0,014	0,016	0,018	0,022	0,024	0,030	0,032	0,036	0,038
10	0,025	0,017	0,020	0,022	0,027	0,030	0,037	0,040	0,045	0,047
12	0,030	0,021	0,024	0,027	0,033	0,036	0,045	0,048	0,054	0,057
14	0,035	0,024	0,028	0,031	0,038	0,042	0,052	0,056	0,063	0,066
16	0,040	0,028	0,032	0,036	0,044	0,048	0,060	0,064	0,072	0,076
18	0,045	0,031	0,036	0,040	0,049	0,054	0,067	0,072	0,081	0,085
20	0,050	0,035	0,040	0,045	0,055	0,060	0,075	0,080	0,090	0,095
25	0,063	0,044	0,050	0,056	0,069	0,075	0,094	0,100	0,113	0,119

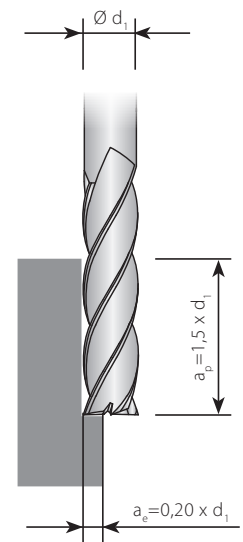

Vorschub pro Zahn bei einer radialen Zustellung 40% vom Schneidendurchmesser ($\varnothing d_1$)
 Feed per tooth with radial depth of cut of 40% of the cutter ($\varnothing d_1$)

$\varnothing d_1$ [mm]	Korrekturfaktor / Correction factor $K_f [f_z]$									
	1	0,7	0,8	0,9	1,1	1,2	1,5	1,6	1,8	1,9
1	0,001	0,001	0,001	0,001	0,001	0,001	0,002	0,002	0,002	0,003
2	0,004	0,002	0,003	0,003	0,004	0,004	0,006	0,006	0,007	0,007
3	0,006	0,004	0,005	0,005	0,007	0,007	0,009	0,010	0,011	0,012
4	0,008	0,005	0,006	0,007	0,008	0,009	0,012	0,012	0,014	0,015
5	0,010	0,007	0,008	0,009	0,011	0,012	0,015	0,016	0,018	0,019
6	0,012	0,008	0,009	0,010	0,013	0,014	0,018	0,019	0,021	0,022
8	0,016	0,011	0,012	0,014	0,017	0,019	0,024	0,025	0,028	0,030
10	0,020	0,014	0,016	0,018	0,022	0,024	0,030	0,032	0,036	0,038
12	0,024	0,016	0,019	0,021	0,026	0,028	0,036	0,038	0,043	0,045
14	0,028	0,019	0,022	0,025	0,030	0,033	0,042	0,044	0,050	0,053
16	0,032	0,022	0,025	0,028	0,035	0,038	0,048	0,051	0,057	0,060
18	0,036	0,025	0,028	0,032	0,039	0,043	0,054	0,057	0,064	0,068
20	0,040	0,028	0,032	0,036	0,044	0,048	0,060	0,064	0,072	0,076
25	0,050	0,035	0,040	0,045	0,055	0,060	0,075	0,080	0,090	0,095

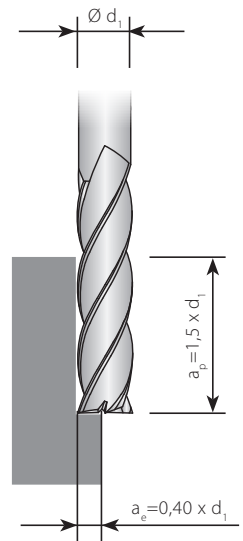

Achtung:
 Vorschub-Korrekturfaktor $\rightarrow K_f f_z = 1,10$ bei $a_p = 1 \times d_1$ und $\rightarrow K_f f_z = 1,25$ bei $a_p = 0,5 \times d_1$
 Für unbeschichtete Werkzeuge ist der Vorschub um 10-20% zu reduzieren.

Attention:
 Feed rate correction factor $\rightarrow K_f f_z = 1,10$ with $a_p = 1 \times d_1$ and $\rightarrow K_f f_z = 1,25$ with $a_p = 0,5 \times d_1$
 Feed rates are reduced by 10-20% for uncoated tools.

Vorschub pro Zahn bei einer radialen Zustellung 60% vom Schneidendurchmesser ($\varnothing d_1$)
 Feed per tooth with radial depth of cut of 60% of the cutter ($\varnothing d_1$)

$\varnothing d_1$ [mm]	Korrekturfaktor / Correction factor Kf [f _z]									
	1	0,7	0,8	0,9	1,1	1,2	1,5	1,6	1,8	1,9
1	0,001	0,001	0,001	0,001	0,001	0,001	0,001	0,002	0,002	0,002
2	0,003	0,002	0,002	0,002	0,003	0,003	0,004	0,005	0,005	0,006
3	0,005	0,003	0,004	0,004	0,005	0,006	0,007	0,008	0,009	0,009
4	0,006	0,004	0,005	0,005	0,007	0,007	0,009	0,010	0,011	0,012
5	0,008	0,005	0,006	0,007	0,009	0,010	0,012	0,013	0,015	0,016
6	0,009	0,006	0,007	0,008	0,010	0,011	0,014	0,015	0,017	0,018
8	0,013	0,009	0,010	0,011	0,014	0,015	0,019	0,020	0,023	0,024
10	0,016	0,011	0,013	0,014	0,017	0,019	0,024	0,026	0,029	0,030
12	0,019	0,013	0,015	0,017	0,021	0,023	0,029	0,031	0,035	0,037
14	0,022	0,015	0,018	0,020	0,025	0,027	0,034	0,036	0,040	0,043
16	0,026	0,018	0,020	0,023	0,028	0,031	0,039	0,041	0,046	0,049
18	0,029	0,020	0,023	0,026	0,032	0,035	0,043	0,046	0,052	0,055
20	0,032	0,022	0,026	0,029	0,035	0,039	0,048	0,052	0,058	0,061
25	0,040	0,028	0,032	0,036	0,045	0,049	0,061	0,065	0,073	0,077

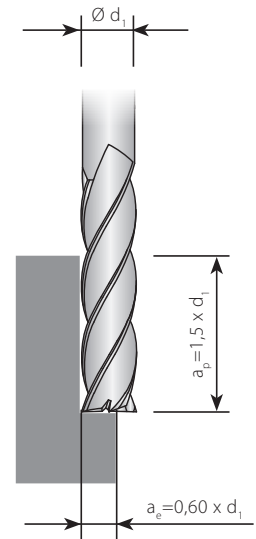

Vorschub pro Zahn bei einer radialen Zustellung 80% vom Schneidendurchmesser ($\varnothing d_1$)
 Feed per tooth with radial depth of cut of 80% of the cutter ($\varnothing d_1$)

$\varnothing d_1$ [mm]	Korrekturfaktor / Correction factor Kf [f _z]									
	1	0,7	0,8	0,9	1,1	1,2	1,5	1,6	1,8	1,9
1	0,001	0,001	0,001	0,001	0,001	0,001	0,001	0,001	0,001	0,001
2	0,002	0,001	0,002	0,002	0,002	0,003	0,003	0,004	0,004	0,004
3	0,004	0,002	0,003	0,003	0,004	0,004	0,006	0,006	0,007	0,007
4	0,005	0,003	0,004	0,004	0,005	0,006	0,007	0,008	0,009	0,009
5	0,006	0,004	0,005	0,005	0,007	0,007	0,009	0,010	0,011	0,012
6	0,007	0,005	0,006	0,006	0,008	0,009	0,011	0,012	0,013	0,014
8	0,010	0,007	0,008	0,009	0,011	0,012	0,015	0,016	0,018	0,019
10	0,012	0,008	0,010	0,011	0,013	0,015	0,018	0,020	0,022	0,023
12	0,015	0,010	0,012	0,013	0,016	0,018	0,022	0,024	0,027	0,028
14	0,017	0,012	0,014	0,015	0,019	0,021	0,026	0,028	0,031	0,033
16	0,020	0,014	0,016	0,018	0,022	0,024	0,030	0,032	0,036	0,038
18	0,022	0,015	0,018	0,020	0,024	0,027	0,033	0,036	0,040	0,042
20	0,025	0,017	0,020	0,022	0,027	0,030	0,037	0,040	0,045	0,047
25	0,031	0,022	0,025	0,028	0,034	0,037	0,047	0,050	0,056	0,059

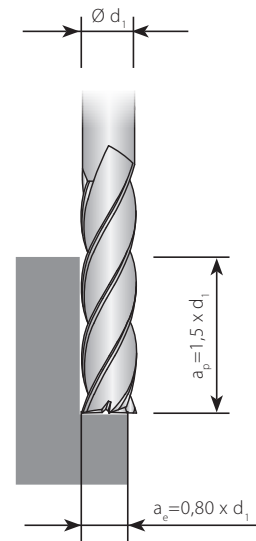

Achtung:
 Vorschub-Korrekturfaktor \rightarrow Kf f_z = 1,10 bei a_p = 1 x d₁ und \rightarrow Kf f_z = 1,25 bei a_p = 0,5 x d₁
 Für unbeschichtete Werkzeuge ist der Vorschub um 10-20% zu reduzieren.

Attention:
 Feed rate correction factor \rightarrow Kf f_z = 1,10 with a_p = 1 x d₁ and \rightarrow Kf f_z = 1,25 with a_p = 0,5 x d₁
 Feed rates are reduced by 10-20% for uncoated tools.

Vorschub pro Zahn beim Vollnutfräsen → $a_p = 0,5 \times d_1$

Feed per tooth when full slot milling → $a_p = 0,5 \times d_1$

Ø d ₁ [mm]	Korrekturfaktor / Correction factor Kf [f ₁]									
	1	0,7	0,8	0,9	1,1	1,2	1,5	1,6	1,8	1,9
1	0,002	0,001	0,001	0,001	0,002	0,002	0,003	0,003	0,003	0,003
2	0,004	0,002	0,003	0,003	0,004	0,004	0,006	0,006	0,007	0,007
3	0,007	0,004	0,005	0,006	0,007	0,008	0,010	0,011	0,012	0,013
4	0,009	0,006	0,007	0,008	0,009	0,010	0,013	0,014	0,016	0,017
5	0,011	0,007	0,008	0,009	0,012	0,013	0,016	0,017	0,019	0,020
6	0,013	0,009	0,010	0,011	0,014	0,015	0,019	0,020	0,023	0,024
8	0,018	0,012	0,014	0,016	0,019	0,021	0,027	0,028	0,032	0,034
10	0,022	0,015	0,017	0,019	0,024	0,026	0,033	0,035	0,039	0,041
12	0,030	0,021	0,024	0,027	0,033	0,036	0,045	0,048	0,054	0,057
14	0,032	0,022	0,025	0,028	0,035	0,038	0,048	0,051	0,057	0,060
16	0,036	0,025	0,028	0,032	0,039	0,043	0,054	0,057	0,064	0,068
18	0,042	0,029	0,033	0,037	0,046	0,050	0,063	0,067	0,075	0,079
20	0,045	0,031	0,036	0,040	0,049	0,054	0,067	0,072	0,081	0,085
25	0,056	0,039	0,044	0,050	0,061	0,067	0,084	0,089	0,100	0,106

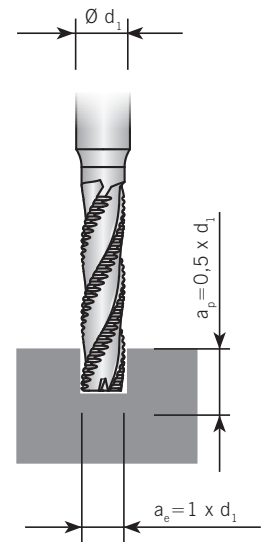

Vorschub pro Zahn beim Vollnutfräsen → $a_p = 1 \times d_1$

Feed per tooth when full slot milling → $a_p = 1 \times d_1$

Ø d ₁ [mm]	Korrekturfaktor / Correction factor Kf [f ₁]									
	1	0,7	0,8	0,9	1,1	1,2	1,5	1,6	1,8	1,9
1	0,001	0,001	0,001	0,001	0,001	0,002	0,002	0,002	0,002	0,002
2	0,003	0,002	0,002	0,002	0,003	0,003	0,004	0,004	0,005	0,005
3	0,005	0,003	0,004	0,004	0,005	0,005	0,007	0,007	0,008	0,009
4	0,006	0,004	0,005	0,005	0,006	0,007	0,009	0,009	0,011	0,011
5	0,007	0,005	0,006	0,006	0,008	0,009	0,011	0,011	0,013	0,014
6	0,008	0,006	0,007	0,008	0,009	0,010	0,013	0,014	0,015	0,016
8	0,012	0,008	0,009	0,011	0,013	0,014	0,018	0,019	0,021	0,022
10	0,014	0,010	0,011	0,013	0,016	0,017	0,021	0,023	0,026	0,027
12	0,020	0,014	0,016	0,018	0,021	0,023	0,029	0,031	0,035	0,037
14	0,021	0,015	0,017	0,019	0,023	0,025	0,031	0,033	0,037	0,040
16	0,023	0,016	0,019	0,021	0,026	0,028	0,035	0,037	0,042	0,044
18	0,027	0,019	0,022	0,025	0,030	0,033	0,041	0,044	0,049	0,052
20	0,029	0,020	0,023	0,026	0,032	0,035	0,044	0,047	0,053	0,056
25	0,036	0,025	0,029	0,033	0,040	0,044	0,055	0,058	0,066	0,069

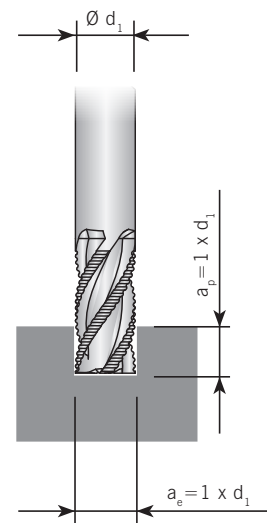

Achtung:

Für unbeschichtete Werkzeuge ist der Vorschub um 10-20% zu reduzieren.

Attention:

Feed rates are reduced by 10-20% for uncoated tools.

Alle Angaben in mm / Dimensions in mm

Vorschübe für Vollradius- und Torusfräser
Feed rates for ball nosed- and torus end-mills

d_1 [mm]	fz [mm]	fz [mm]	fz [mm]	fz [mm]	fz [mm]
2	0,015	0,010	0,005	0,010	0,015
3	0,030	0,020	0,015	0,015	0,020
4	0,040	0,030	0,030	0,020	0,030
5	0,060	0,050	0,050	0,030	0,040
6	0,070	0,060	0,060	0,050	0,060
8	0,100	0,080	0,070	0,070	0,080
10	0,120	0,100	0,080	0,080	0,100
12	0,150	0,120	0,090	0,100	0,120
16	0,180	0,150	0,100	0,120	0,150
18	0,200	0,180	0,110	0,140	0,160
20	0,220	0,200	0,120	0,150	0,180
25	0,250	0,240	0,140	0,170	0,200

Achtung:
Für unbeschichtete Werkzeuge ist der Vorschub um 10-20% zu reduzieren.

Attention:
Feed rates are reduced by 10-20% for uncoated tools.

ARNO[®]

WERKZEUGE

We have a passion for precision.

AUSFÜHRUNG AFA

Design AFA

**„High Performance“ bei der Zerspanung
von Aluminium und Nichteisenmetallen.**

**High performance for aluminium
and non-ferrous materials.**

Die speziell entwickelte Geometrie mit
höchststabiler Schneidkante gewährleistet
beste Oberflächengüte bei ausgezeichneter
Spanabfuhr.

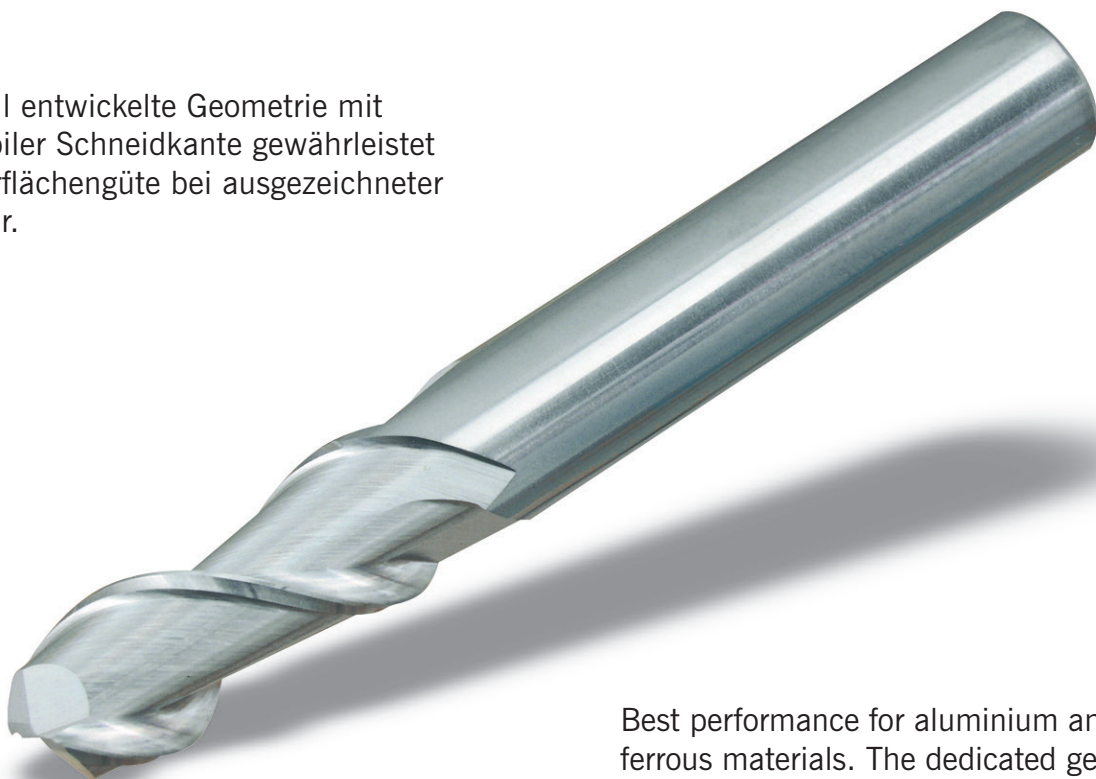

Best performance for aluminium and non-ferrous materials. The dedicated geometry with a very strong cutting edge guarantees best surface finish and excellent chip flow.

VHM-Schaftfräser

1 Schneide, mittellange Ausführung

Solid carbide end-mill

1 flute, mid-length design

AFA



N NEU/NEW

1
30°
HA
Seite Page 98-105

TiCN ✓
Feinstkorn Ultra micro granulation ✓

P	N ●
M	S
K	H

AFA50116-...

Schaft / Shank DIN 6535HA	d	d _A	l ₁	l
AFA50116-020 N	2,0	3,0	8,0	50
AFA50116-030 N	3,0	3,0	12,0	50
AFA50116-040 N	4,0	4,0	15,0	60
AFA50116-050 N	5,0	5,0	17,0	60
AFA50116-060 N	6,0	6,0	20,0	65
AFA50116-080 N	8,0	8,0	22,0	65
AFA50116-100 N	10,0	10,0	25,0	75
AFA50116-120 N	12,0	12,0	30,0	80

Toleranz / Tolerance	
Fräser / Mill	0 -0,03
Schaft / Shank	h6

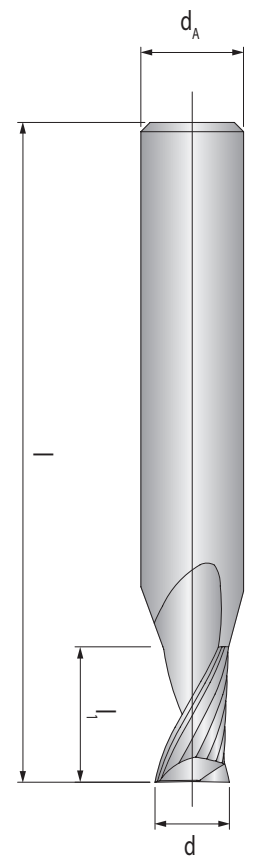

VHM-Schaftfräser

2 Schneiden, kurze Ausführung



N NEU/NEW

Solid carbide end-mill

2 flutes, short design

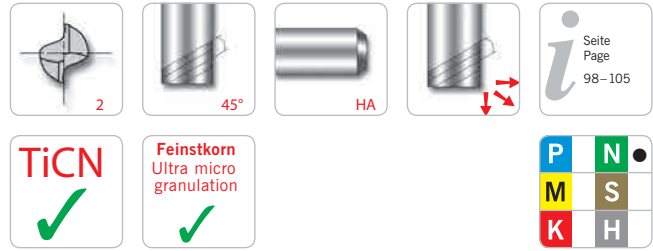

AFA

AFA50220-...

Schaft / Shank DIN 6535HA	d	d _A	l ₁	l
AFA50220-030 N	3,0	6,0	5,0	50
AFA50220-040 N	4,0	6,0	8,0	54
AFA50220-050 N	5,0	6,0	9,0	54
AFA50220-060 N	6,0	6,0	10,0	54
AFA50220-080 N	8,0	8,0	12,0	58
AFA50220-100 N	10,0	10,0	14,0	66
AFA50220-120 N	12,0	12,0	16,0	73
AFA50220-140 N	14,0	14,0	18,0	75
AFA50220-160 N	16,0	16,0	22,0	82
AFA50220-180 N	18,0	18,0	24,0	84
AFA50220-200 N	20,0	20,0	26,0	92

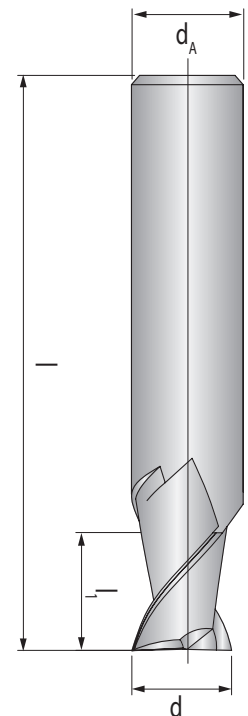

Toleranz / Tolerance	
Fräser / Mill	0 -0,015
Schaft / Shank	h6

● = Hauptanwendung / Main application
○ = Nebenanwendung / Suitable

Alle Angaben in mm / Dimensions in mm

VHM-Radiusfräser

2 Schneiden, kurze Ausführung

Solid carbide ball-nose end-mill

2 flutes, short design

AFA

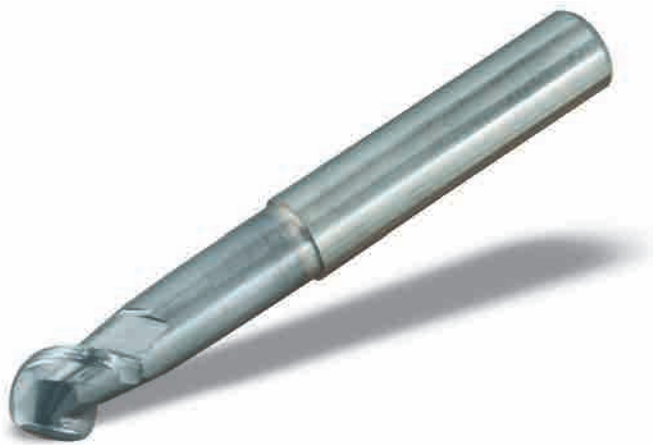

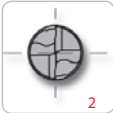

2



50°



HA

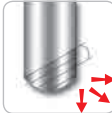



Seite
Page
98-105



TiCN



Feinstkorn
Ultra micro
granulation

P	N ●
M	S
K	H

AFA51820-...

Schaft / Shank DIN 6535HA	d	d _A	d ₃	l ₁	l ₂	l	R
AFA51820-060	6,0	6,0	5,40	5,5	25	55	3,00
AFA51820-080	8,0	8,0	7,20	7,0	30	65	4,00
AFA51820-100	10,0	10,0	9,00	8,5	35	75	5,00
AFA51820-120	12,0	12,0	11,00	10,5	40	75	6,00
AFA51820-160	16,0	16,0	14,50	14,0	50	90	8,00
AFA51820-200	20,0	20,0	18,00	17,0	50	100	10,00

Toleranz / Tolerance	
Fräser / Mill	⁰ -0,02
Radius / Radius	±0,01
Schaft / Shank	h6

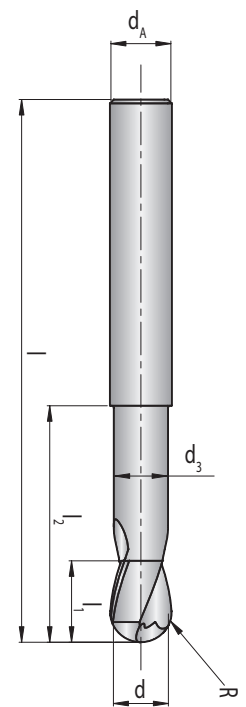

VHM-Schaftfräser

2 Schneiden, lange Ausführung, unbeschichtet



Solid carbide end-mill

2 flutes, long design, uncoated

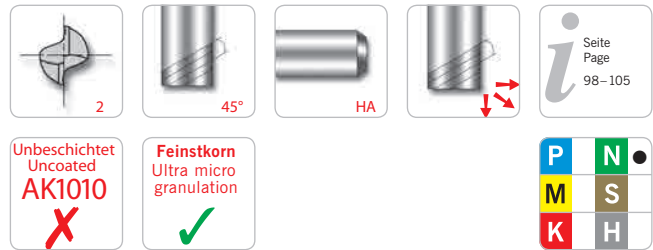

AFA51521-...

Schaft / Shank DIN 6535HA	d	d _A	l ₁	l
AFA51521-030	3,0	6,0	8,0	57
AFA51521-040	4,0	6,0	11,0	57
AFA51521-050	5,0	6,0	13,0	57
AFA51521-060	6,0	6,0	13,0	57
AFA51521-080	8,0	8,0	19,0	63
AFA51521-100	10,0	10,0	22,0	72
AFA51521-120	12,0	12,0	26,0	83
AFA51521-160	16,0	16,0	32,0	92
AFA51521-200	20,0	20,0	38,0	104

Toleranz / Tolerance

Fräser / Mill	0 -0,03
Schaft / Shank	h6

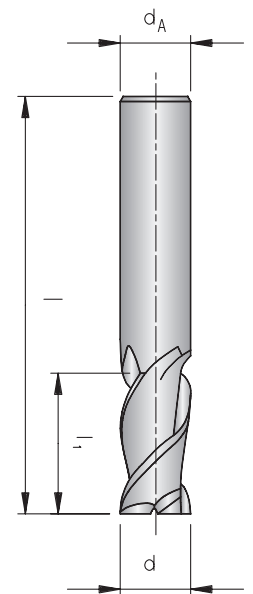

Achtung: Vc -30% bei unbeschichteten Werkzeugen

Attention: Vc -30% with uncoated tools

● = Hauptanwendung / Main application
○ = Nebenanwendung / Suitable

Alle Angaben in mm / Dimensions in mm

VHM-Schaftfräser

2 Schneiden, lange Ausführung mit Eckenradius

Solid carbide end-mill

2 flutes, long design with corner radius

AFA

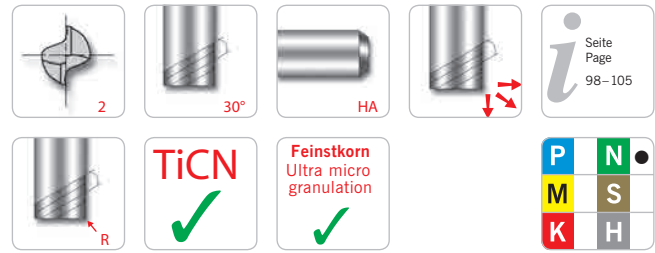
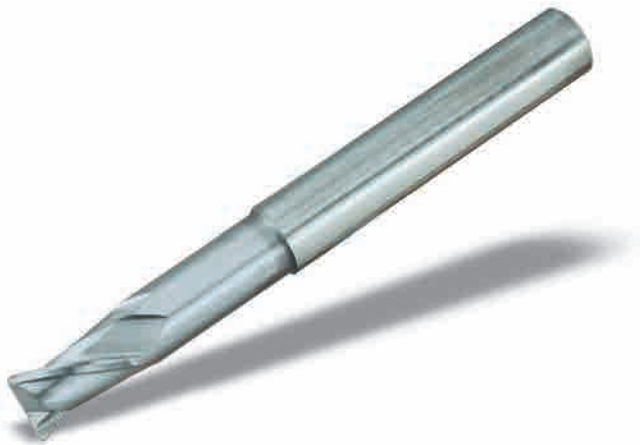

AFA50720-...R...

Schaft / Shank DIN 6535HA	d	d _A	d ₃	l ₁	l ₂	l	R
AFA50720-040R0,3	4,0	6,0	3,60	5,0	10	50	0,30
AFA50720-060R0,5	6,0	6,0	5,40	8,0	20	60	0,50
AFA50720-080R0,6	8,0	8,0	7,20	10,0	30	70	0,60
AFA50720-100R0,8	10,0	10,0	9,00	12,0	36	80	0,80
AFA50720-120R1,0	12,0	12,0	11,00	14,0	40	90	1,00
AFA50720-160R1,3	16,0	16,0	14,50	18,0	45	100	1,30
AFA50720-200R1,6	20,0	20,0	18,00	24,0	45	100	1,60

Toleranz / Tolerance	
Fräser / Mill	⁰ _{-0,03}
Schaft / Shank	h6

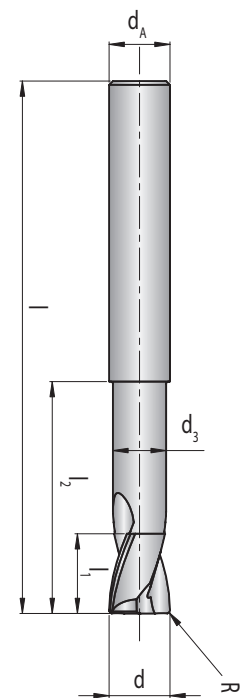

● = Hauptanwendung / Main application
○ = Nebenanwendung / Suitable

Alle Angaben in mm / Dimensions in mm

VHM-Schaftfräser

2 Schneiden, extra lange Ausführung



Solid carbide end-mill

2 flutes, extra long design



2



45°



HA

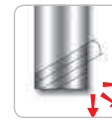

Seite
Page
98-105



TiCN



Feinstkorn
Ultra micro
granulation



AFA

AFA51522-...

Schaft / Shank DIN 6535HA	d	d _A	l ₁	l
AFA51522-010	1,0	6,0	3,0	40
AFA51522-015	1,5	6,0	5,0	40
AFA51522-020	2,0	6,0	6,0	40
AFA51522-025	2,5	6,0	8,0	40
AFA51522-030	3,0	6,0	11,0	50
AFA51522-040	4,0	6,0	13,0	50
AFA51522-040A	4,0	6,0	16,0	70
AFA51522-050	5,0	6,0	17,0	55
AFA51522-050A	5,0	6,0	22,0	70
AFA51522-060	6,0	6,0	17,0	55
AFA51522-060A	6,0	6,0	22,0	70
AFA51522-070	7,0	8,0	22,0	65
AFA51522-080	8,0	8,0	22,0	65
AFA51522-080A	8,0	8,0	28,0	80
AFA51522-090	9,0	10,0	27,0	70
AFA51522-100	10,0	10,0	27,0	70
AFA51522-100A	10,0	10,0	32,0	90
AFA51522-120	12,0	12,0	32,0	80
AFA51522-120A	12,0	12,0	38,0	95
AFA51522-140	14,0	14,0	37,0	85
AFA51522-160	16,0	16,0	42,0	100
AFA51522-160A	16,0	16,0	52,0	110
AFA51522-180	18,0	16,0	48,0	110
AFA51522-200	20,0	20,0	48,0	110
AFA51522-200A	20,0	20,0	55,0	110

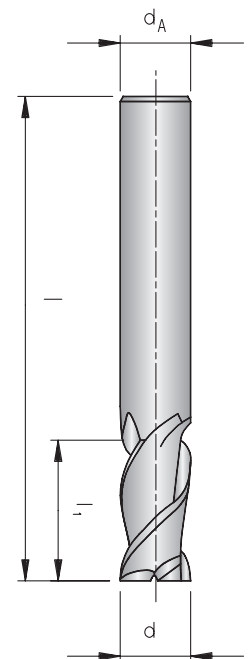

Toleranz / Tolerance	
Fräser / Mill	0 -0,03
Schaft / Shank	h6

● = Hauptanwendung / Main application
○ = Nebenanwendung / Suitable

Alle Angaben in mm / Dimensions in mm

VHM-Schaftfräser

2 Schneiden, extra lange Ausführung

Solid carbide end-mill

2 flutes, extra long design

AFA



N NEU/NEW

Seite Page 98-105

P	N ●
M	S
K	H

TiCN ✓

Feinstkorn Ultra micro granulation ✓

AFA50222-...

Schaft / Shank DIN 6535HA	d	d _A	l ₁	l
AFA50222-010A N	1,0	6,0	3,0	50
AFA50222-010B N	1,0	6,0	6,0	60
AFA50222-012A N	1,2	6,0	4,0	50
AFA50222-015A N	1,5	6,0	5,0	50
AFA50222-015B N	1,5	6,0	8,0	60
AFA50222-020A N	2,0	6,0	6,0	50
AFA50222-020B N	2,0	6,0	10,0	60
AFA50222-025A N	2,5	6,0	8,0	55
AFA50222-030A N	3,0	6,0	11,0	55
AFA50222-030B N	3,0	6,0	15,0	65
AFA50222-040A N	4,0	6,0	13,0	55
AFA50222-040B N	4,0	6,0	16,0	65
AFA50222-050A N	5,0	6,0	17,0	55
AFA50222-050B N	5,0	6,0	22,0	60
AFA50222-060A N	6,0	6,0	17,0	60
AFA50222-060B N	6,0	6,0	25,0	70
AFA50222-070A N	7,0	8,0	22,0	65
AFA50222-080A N	8,0	8,0	22,0	70
AFA50222-080B N	8,0	8,0	30,0	80
AFA50222-100A N	10,0	10,0	27,0	75
AFA50222-100B N	10,0	10,0	35,0	90
AFA50222-120A N	12,0	12,0	32,0	80
AFA50222-120B N	12,0	12,0	40,0	95
AFA50222-140A N	14,0	16,0	37,0	90
AFA50222-160A N	16,0	16,0	42,0	100
AFA50222-160B N	16,0	16,0	52,0	110
AFA50222-180A N	18,0	16,0	48,0	100
AFA50222-200A N	20,0	20,0	48,0	100
AFA50222-200B N	20,0	20,0	55,0	110

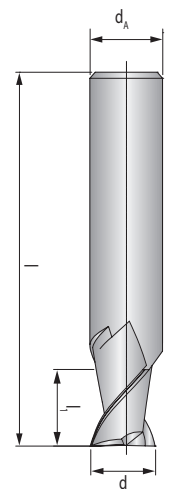

Toleranz / Tolerance	
Fräser / Mill	0 -0,015
Schaft / Shank	h6

● = Hauptanwendung / Main application
○ = Nebenanwendung / Suitable

Alle Angaben in mm / Dimensions in mm

VHM-Schaftfräser

3 Schneiden, mittellange Ausführung



N NEU/NEW

Solid carbide end-mill

3 flutes, mid-length design



3



45°



HA

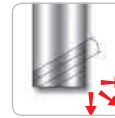

Seite
Page
98-105



TiCN



Feinstkorn
Ultra micro
granulation



P	N ●
M	S
K	H

AFA

AFA51836-...

Schaft / Shank DIN 6535HA	d	d _A	l ₁	l ₂	l
AFA51836-060 N	6,0	6,0	13,0	20	70
AFA51836-080 N	8,0	8,0	19,0	26	80
AFA51836-100 N	10,0	10,0	22,0	32	80
AFA51836-120 N	12,0	12,0	26,0	36	90
AFA51836-140 N	14,0	16,0	28,0	40	110
AFA51836-160 N	16,0	16,0	32,0	46	120
AFA51836-180 N	18,0	20,0	35,0	50	120
AFA51836-200 N	20,0	20,0	38,0	52	120

Toleranz / Tolerance

Fräser / Mill	0 -0,03
Schaft / Shank	h6

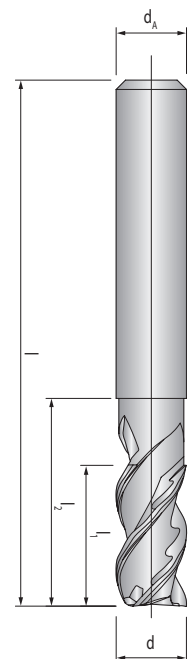

● = Hauptanwendung / Main application
○ = Nebenanwendung / Suitable

Alle Angaben in mm / Dimensions in mm

VHM-Schaftfräser

3 Schneiden, mittellange Ausführung, abgesetzter Schaft

Solid carbide end-mill

3 flutes, mid-length design, with neck



N NEU/NEW



3



45°



HA

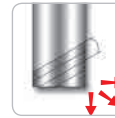

Seite
Page
98-105



TiCN



Feinstkorn
Ultra micro
granulation



AFA52336-...

Schaft / Shank DIN 6535HA	d	d _A	l ₁	l ₂	l
AFA52336-030 N	3,0	6,0	8,0	12	57
AFA52336-040 N	4,0	6,0	11,0	18	57
AFA52336-050 N	5,0	6,0	13,0	18	57
AFA52336-060 N	6,0	6,0	13,0	18	57
AFA52336-080 N	8,0	8,0	21,0	25	63
AFA52336-100 N	10,0	10,0	22,0	30	72
AFA52336-120 N	12,0	12,0	26,0	36	83
AFA52336-160 N	16,0	16,0	36,0	42	92
AFA52336-200 N	20,0	20,0	41,0	52	104

Toleranz / Tolerance	
Fräser / Mill	0 -0,015
Schaft / Shank	h6

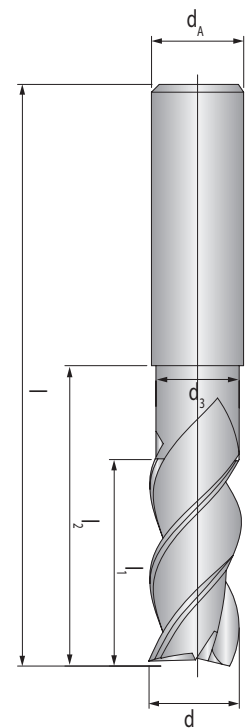

● = Hauptanwendung / Main application
○ = Nebenanwendung / Suitable

Alle Angaben in mm / Dimensions in mm

VHM-Schaftfräser

3 Schneiden, lange Ausführung, unbeschichtet

Solid carbide end-mill

3 flutes, long design, uncoated

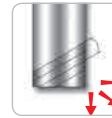
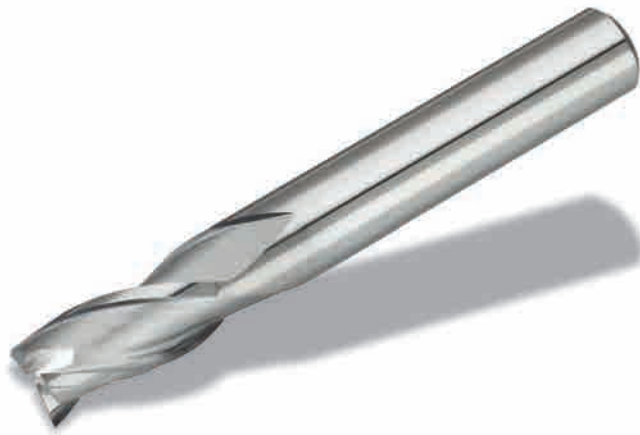

AFA

AFA52330-...

Schaft / Shank DIN 6535HA	d h10	d _A h6	l ₁	l
AFA52330-035	3,5	3,5	7,0	50
AFA52330-040	4,0	4,0	8,0	50
AFA52330-045	4,5	4,5	8,0	50
AFA52330-050	5,0	5,0	10,0	50
AFA52330-055	5,5	5,5	10,0	57
AFA52330-060	6,0	6,0	10,0	57
AFA52330-065	6,5	6,5	13,0	60
AFA52330-070	7,0	7,0	13,0	60
AFA52330-075	7,5	7,5	16,0	63
AFA52330-080	8,0	8,0	16,0	63
AFA52330-085	8,5	8,5	16,0	67
AFA52330-090	9,0	9,0	16,0	67
AFA52330-095	9,5	9,5	19,0	72
AFA52330-100	10,0	10,0	19,0	72
AFA52330-110	11,0	11,0	22,0	83
AFA52330-120	12,0	12,0	22,0	83
AFA52330-130	13,0	13,0	22,0	83
AFA52330-140	14,0	14,0	22,0	83
AFA52330-150	15,0	15,0	26,0	92
AFA52330-160	16,0	16,0	26,0	92
AFA52330-180	18,0	18,0	26,0	92
AFA52330-200	20,0	20,0	32,0	104

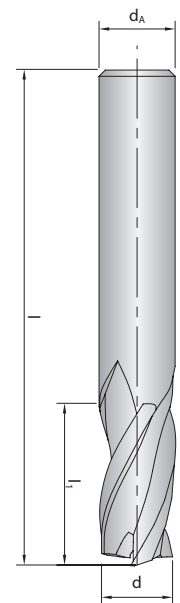

Toleranz / Tolerance (µm)	Nennwertbereich / Diameter range (mm)				
	≥ 1 - 3	> 3 - 6	> 6 - 10	> 10 - 18	> 18 - 30
h10	0 -40	0 -48	0 -58	0 -70	0 -84
h6	0 -6	0 -8	0 -9	0 -11	0 -13

Achtung: Vc -30% bei unbeschichteten Werkzeugen

Attention: Vc -30% with uncoated tools

● = Hauptanwendung / Main application
○ = Nebenanwendung / Suitable

Alle Angaben in mm / Dimensions in mm

VHM-Schaftfräser

3 Schneiden, lange Ausführung

Solid carbide end-mill

3 flutes, long design

AFA



3
45°
HA

Seite Page 98-105

P	N ●
M	S
K	H

TiCN ✓
Feinstkorn Ultra micro granulation ✓

AFA51531...

Schaft / Shank DIN 6535HA	d	d _A	l ₁	l
AFA51531-030	3,0	6,0	11,0	50
AFA51531-030A	3,0	6,0	14,0	65
AFA51531-040	4,0	6,0	13,0	50
AFA51531-040A	4,0	6,0	16,0	65
AFA51531-050	5,0	6,0	17,0	55
AFA51531-050A	5,0	6,0	22,0	70
AFA51531-060	6,0	6,0	17,0	55
AFA51531-060A	6,0	6,0	22,0	70
AFA51531-070	7,0	8,0	22,0	65
AFA51531-080	8,0	8,0	22,0	65
AFA51531-080A	8,0	8,0	28,0	80
AFA51531-090	9,0	10,0	27,0	70
AFA51531-100	10,0	10,0	27,0	70
AFA51531-100A	10,0	10,0	32,0	90
AFA51531-120	12,0	12,0	32,0	80
AFA51531-120A	12,0	12,0	38,0	95
AFA51531-140	14,0	14,0	37,0	85
AFA51531-160	16,0	16,0	42,0	100
AFA51531-160A	16,0	16,0	52,0	110
AFA51531-180	18,0	16,0	48,0	110
AFA51531-200	20,0	20,0	48,0	110
AFA51531-200A	20,0	20,0	55,0	110

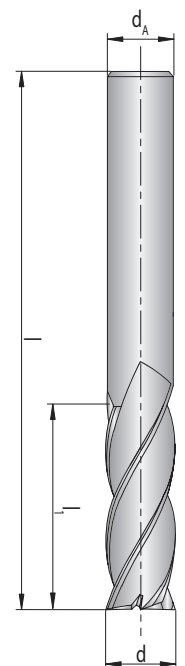

Toleranz / Tolerance	
Fräser / Mill	0 -0,03
Schaft / Shank	h6

● = Hauptanwendung / Main application
○ = Nebenanwendung / Suitable

Alle Angaben in mm / Dimensions in mm

VHM-Schaftfräser

3 Schneiden, lange Ausführung, mit Eckenradius



N NEU/NEW

Solid carbide end-mill

3 flutes, long design, with corner radius

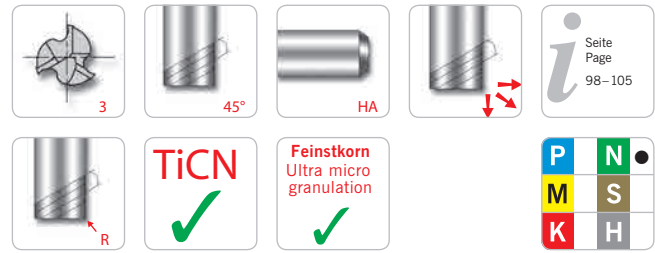

AFA

AFA50231-...R...

Schaft / Shank DIN 6535HA	d	d _A	l ₁	l	R
AFA50231-030R0,5 N	3,0	6,0	12,0	57	0,50
AFA50231-030R1,0 N	3,0	6,0	12,0	57	1,00
AFA50231-040R0,5 N	4,0	6,0	15,0	57	0,50
AFA50231-040R1,0 N	4,0	6,0	15,0	57	1,00
AFA50231-050R0,5 N	5,0	6,0	20,0	57	0,50
AFA50231-050R1,0 N	5,0	6,0	20,0	57	1,00
AFA50231-060R0,5 N	6,0	6,0	20,0	65	0,50
AFA50231-060R1,0 N	6,0	6,0	20,0	65	1,00
AFA50231-080R0,5 N	8,0	8,0	22,0	65	0,50
AFA50231-080R1,0 N	8,0	8,0	22,0	65	1,00
AFA50231-100R0,5 N	10,0	10,0	25,0	70	0,50
AFA50231-100R1,0 N	10,0	10,0	25,0	70	1,00
AFA50231-100R2,0 N	10,0	10,0	25,0	70	2,00
AFA50231-120R0,5 N	12,0	12,0	25,0	75	0,50
AFA50231-120R1,0 N	12,0	12,0	25,0	75	1,00
AFA50231-120R2,0 N	12,0	12,0	25,0	75	2,00
AFA50231-160R0,5 N	16,0	16,0	35,0	90	0,50
AFA50231-160R1,0 N	16,0	16,0	35,0	90	1,00
AFA50231-160R2,0 N	16,0	16,0	35,0	90	2,00
AFA50231-200R0,5 N	20,0	20,0	40,0	100	0,50
AFA50231-200R1,0 N	20,0	20,0	40,0	100	1,00
AFA50231-200R2,0 N	20,0	20,0	40,0	100	2,00

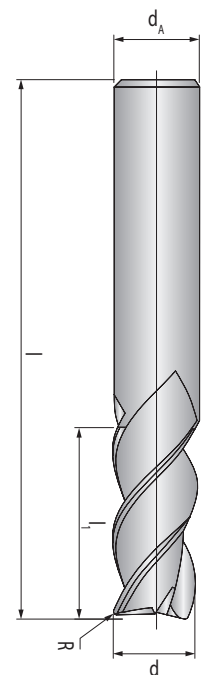

Toleranz / Tolerance	
Fräser / Mill	0 -0,015
Schaft / Shank	h6

● = Hauptanwendung / Main application
○ = Nebenanwendung / Suitable

Alle Angaben in mm / Dimensions in mm

VHM-Schaftfräser

3 Schneiden, extra lange Ausführung

Solid carbide end-mill

3 flutes, extra long design

AFA

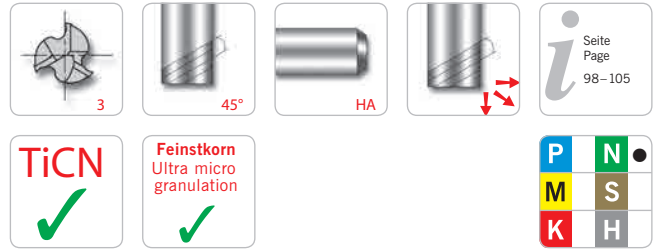

AFA51532-...

Schaft / Shank DIN 6535HA	d	d _A	l ₁	l
AFA51532-030A	3,0	6,0	15,0	65
AFA51532-030B	3,0	6,0	20,0	70
AFA51532-030C	3,0	6,0	25,0	75
AFA51532-040A	4,0	6,0	20,0	70
AFA51532-040B	4,0	6,0	25,0	75
AFA51532-040C	4,0	6,0	30,0	80
AFA51532-050A	5,0	6,0	25,0	70
AFA51532-050B	5,0	6,0	30,0	75
AFA51532-050C	5,0	6,0	35,0	80
AFA51532-060A	6,0	6,0	25,0	70
AFA51532-060B	6,0	6,0	30,0	75
AFA51532-060C	6,0	6,0	35,0	80
AFA51532-060D	6,0	6,0	42,0	90
AFA51532-080A	8,0	8,0	30,0	80
AFA51532-080B	8,0	8,0	35,0	85
AFA51532-080C	8,0	8,0	40,0	90
AFA51532-080D	8,0	8,0	45,0	95
AFA51532-100A	10,0	10,0	35,0	90
AFA51532-100B	10,0	10,0	45,0	100
AFA51532-100C	10,0	10,0	55,0	110
AFA51532-100D	10,0	10,0	65,0	120
AFA51532-120A	12,0	12,0	40,0	95
AFA51532-120B	12,0	12,0	45,0	100
AFA51532-120C	12,0	12,0	55,0	110
AFA51532-120D	12,0	12,0	65,0	120
AFA51532-120E	12,0	12,0	75,0	135
AFA51532-120F	12,0	12,0	60,0	110
AFA51532-160A	16,0	16,0	55,0	120
AFA51532-160B	16,0	16,0	65,0	135
AFA51532-160C	16,0	16,0	75,0	150
AFA51532-160D	16,0	16,0	85,0	160
AFA51532-160E	16,0	16,0	95,0	180
AFA51532-160F	16,0	16,0	105,0	190
AFA51532-160G	16,0	16,0	115,0	200
AFA51532-200A	20,0	20,0	55,0	125
AFA51532-200B	20,0	20,0	65,0	140
AFA51532-200C	20,0	20,0	75,0	150
AFA51532-200D	20,0	20,0	85,0	160
AFA51532-200E	20,0	20,0	95,0	180
AFA51532-200F	20,0	20,0	105,0	190
AFA51532-200G	20,0	20,0	115,0	200
AFA51532-200H	20,0	20,0	125,0	220

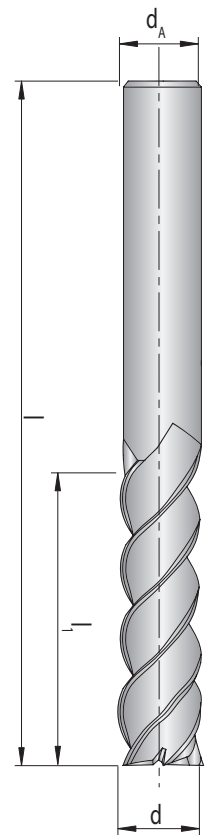

Toleranz / Tolerance	
Fräser / Mill	0 -0,03
Schaft / Shank	h6

● = Hauptanwendung / Main application
○ = Nebenanwendung / Suitable

Alle Angaben in mm / Dimensions in mm

VHM-Schaftfräser

3 Schneiden, extra lange Ausführung



N NEU/NEW

Solid carbide end-mill

3 flutes, extra long design

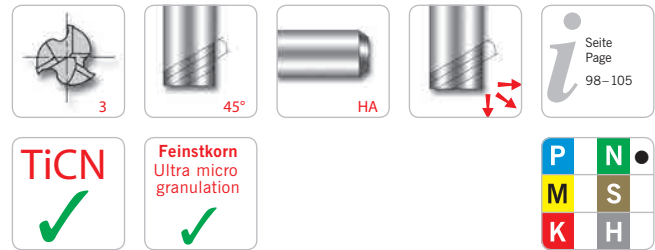

AFA50232-...

Schaft / Shank DIN 6535HA	d	d _A	l ₁	l
AFA50232-010A N	1,0	6,0	3,0	50
AFA50232-010B N	1,0	6,0	2,0	40
AFA50232-010C N	1,0	6,0	2,5	40
AFA50232-010D N	1,0	6,0	4,0	60
AFA50232-010E N	1,0	6,0	6,0	60
AFA50232-012A N	1,2	6,0	4,0	50
AFA50232-015A N	1,5	6,0	5,0	50
AFA50232-015B N	1,5	6,0	3,0	40
AFA50232-015C N	1,5	6,0	8,0	60
AFA50232-015D N	1,5	6,0	10,0	60
AFA50232-020A N	2,0	6,0	6,0	50
AFA50232-020B N	2,0	6,0	3,0	40
AFA50232-020C N	2,0	6,0	8,0	60
AFA50232-020D N	2,0	6,0	10,0	60
AFA50232-020E N	2,0	6,0	12,0	60
AFA50232-025A N	2,5	6,0	10,0	55
AFA50232-025B N	2,5	6,0	8,0	40
AFA50232-025C N	2,5	6,0	12,0	60
AFA50232-030A N	3,0	6,0	11,0	55
AFA50232-030B N	3,0	6,0	4,0	45
AFA50232-030C N	3,0	6,0	8,0	45
AFA50232-030D N	3,0	6,0	15,0	65
AFA50232-030E N	3,0	6,0	20,0	70
AFA50232-030F N	3,0	6,0	25,0	75
AFA50232-030G N	3,0	6,0	30,0	80
AFA50232-035A N	3,5	6,0	12,0	55
AFA50232-040A N	4,0	6,0	13,0	55
AFA50232-040B N	4,0	6,0	5,0	45
AFA50232-040C N	4,0	6,0	11,0	45
AFA50232-040D N	4,0	6,0	16,0	65
AFA50232-040E N	4,0	6,0	20,0	70
AFA50232-040F N	4,0	6,0	26,0	75
AFA50232-040G N	4,0	6,0	30,0	80
AFA50232-045A N	4,5	6,0	15,0	55
AFA50232-050A N	5,0	6,0	17,0	55
AFA50232-050B N	5,0	6,0	6,0	45
AFA50232-050C N	5,0	6,0	22,0	60
AFA50232-050D N	5,0	6,0	25,0	70
AFA50232-050E N	5,0	6,0	30,0	75
AFA50232-050F N	5,0	6,0	35,0	80
AFA50232-050G N	5,0	6,0	40,0	85
AFA50232-050H N	5,0	6,0	45,0	90
AFA50232-055A N	5,5	6,0	17,0	55

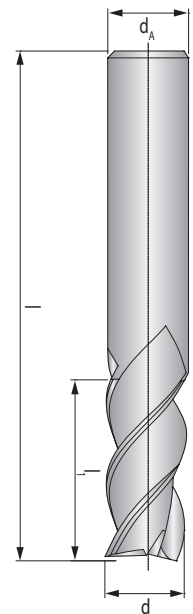

● = Hauptanwendung / Main application
○ = Nebenanwendung / Suitable

Alle Angaben in mm / Dimensions in mm

AFA50232-...

AFA

Schaft / Shank DIN 6535HA	d	d _A	l ₁	l
AFA50232-060A ●	6,0	6,0	17,0	60
AFA50232-060B ●	6,0	6,0	7,0	50
AFA50232-060C ●	6,0	6,0	13,0	50
AFA50232-060D ●	6,0	6,0	22,0	60
AFA50232-060E ●	6,0	6,0	25,0	70
AFA50232-060F ●	6,0	6,0	30,0	75
AFA50232-060G ●	6,0	6,0	35,0	80
AFA50232-060H ●	6,0	6,0	42,0	90
AFA50232-060I ●	6,0	6,0	50,0	100
AFA50232-070A ●	7,0	8,0	22,0	65
AFA50232-080A ●	8,0	8,0	22,0	70
AFA50232-080B ●	8,0	8,0	9,0	60
AFA50232-080C ●	8,0	8,0	19,0	60
AFA50232-080D ●	8,0	8,0	28,0	80
AFA50232-080E ●	8,0	8,0	30,0	80
AFA50232-080F ●	8,0	8,0	35,0	85
AFA50232-080G ●	8,0	8,0	40,0	90
AFA50232-080H ●	8,0	8,0	45,0	95
AFA50232-080I ●	8,0	8,0	50,0	100
AFA50232-080J ●	8,0	8,0	55,0	105
AFA50232-080K ●	8,0	8,0	65,0	110
AFA50232-090A ●	9,0	10,0	27,0	70
AFA50232-100A ●	10,0	10,0	27,0	75
AFA50232-100B ●	10,0	10,0	11,0	65
AFA50232-100C ●	10,0	10,0	22,0	65
AFA50232-100D ●	10,0	10,0	32,0	90
AFA50232-100E ●	10,0	10,0	35,0	90
AFA50232-100F ●	10,0	10,0	40,0	90
AFA50232-100G ●	10,0	10,0	45,0	100
AFA50232-100H ●	10,0	10,0	50,0	100
AFA50232-100I ●	10,0	10,0	55,0	110
AFA50232-100J ●	10,0	10,0	60,0	110
AFA50232-100K ●	10,0	10,0	65,0	120
AFA50232-120A ●	12,0	12,0	32,0	80
AFA50232-120B ●	12,0	12,0	13,0	70
AFA50232-120C ●	12,0	12,0	26,0	70
AFA50232-120D ●	12,0	12,0	40,0	95
AFA50232-120E ●	12,0	12,0	45,0	100
AFA50232-120F ●	12,0	12,0	50,0	100
AFA50232-120G ●	12,0	12,0	55,0	110
AFA50232-120H ●	12,0	12,0	60,0	110
AFA50232-120I ●	12,0	12,0	65,0	120
AFA50232-120J ●	12,0	12,0	70,0	120
AFA50232-120K ●	12,0	12,0	75,0	135
AFA50232-140A ●	14,0	16,0	37,0	90
AFA50232-160A ●	16,0	16,0	18,0	90
AFA50232-160B ●	16,0	16,0	32,0	90
AFA50232-160C ●	16,0	16,0	42,0	100
AFA50232-160D ●	16,0	16,0	52,0	105
AFA50232-160E ●	16,0	16,0	55,0	110
AFA50232-160F ●	16,0	16,0	65,0	130
AFA50232-160G ●	16,0	16,0	75,0	150
AFA50232-160H ●	16,0	16,0	85,0	160
AFA50232-160I ●	16,0	16,0	95,0	180
AFA50232-160J ●	16,0	16,0	105,0	190
AFA50232-160K ●	16,0	16,0	115,0	200
AFA50232-180A ●	18,0	16,0	48,0	100
AFA50232-200A ●	20,0	20,0	22,0	90
AFA50232-200B ●	20,0	20,0	38,0	90

● = Hauptanwendung / Main application
○ = Nebenanwendung / Suitable

Alle Angaben in mm / Dimensions in mm









VHM-Schaftfräser

3 Schneiden, extra lange Ausführung

Solid carbide end-mill

3 flutes, extra long design

AFA50232-...

Schaft / Shank DIN 6535HA	d	d _A	l ₁	l
AFA50232-200C 	20,0	20,0	48,0	100
AFA50232-200D 	20,0	20,0	55,0	110
AFA50232-200E 	20,0	20,0	65,0	130
AFA50232-200F 	20,0	20,0	75,0	150
AFA50232-200G 	20,0	20,0	85,0	160
AFA50232-200H 	20,0	20,0	95,0	180
AFA50232-200I 	20,0	20,0	105,0	190
AFA50232-200J 	20,0	20,0	115,0	200
AFA50232-200K 	20,0	20,0	125,0	220

Toleranz / Tolerance	
Fräser / Mill	0 -0,015
Schaft / Shank	h6

● = Hauptanwendung / Main application
○ = Nebenanwendung / Suitable

Alle Angaben in mm / Dimensions in mm

VHM-Radiusfräser

3 Schneiden, kurze Ausführung

Solid carbide ball-nose end-mill

3 flutes, short design

AFA



N NEU/NEW

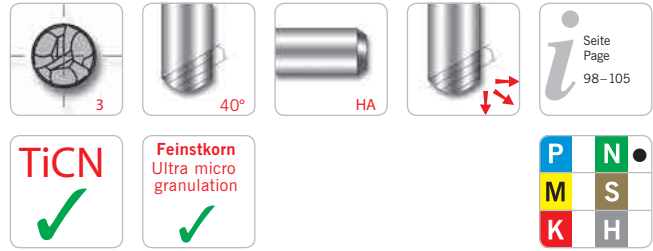

AFA51831-...

Schaft / Shank DIN 6535HA	d	d _A	d ₃	l ₁	l ₂	l	R
AFA51831-020	2,0	6,0	1,90	3,0	5	60	1,00
AFA51831-025	2,5	6,0	2,40	4,0	6	60	1,25
AFA51831-030	3,0	6,0	2,80	4,5	6,5	60	1,50
AFA51831-035	3,5	6,0	3,20	5,0	7	65	1,75
AFA51831-040	4,0	6,0	3,70	6,0	8	65	2,00
AFA51831-050	5,0	6,0	4,60	7,5	10	65	2,50
AFA51831-060	6,0	6,0	5,60	9,0	12	75	3,00
AFA51831-080	8,0	8,0	7,40	12,0	25	75	4,00
AFA51831-100	10,0	10,0	9,40	15,0	30	80	5,00
AFA51831-120	12,0	12,0	11,40	18,0	36	90	6,00
AFA51831-160	16,0	16,0	15,40	24,0	40	100	8,00
AFA51831-200 N	20,0	20,0	18,00	30,0	50	110	10,00

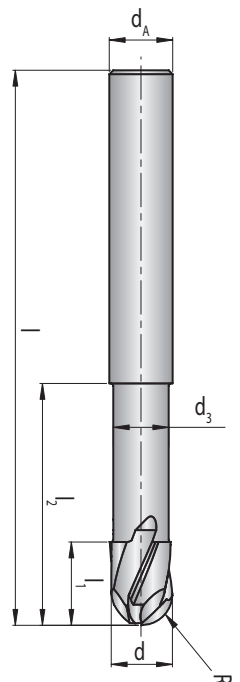

Toleranz / Tolerance	
Fräser / Mill	0 -0,03
Radius / Radius	±0,01
Schaft / Shank	h6

● = Hauptanwendung / Main application
○ = Nebenanwendung / Suitable

VHM-Schruppfräser

3 Schneiden, lange Ausführung, unbeschichtet

Solid carbide roughing end-mill

3 flutes, long design, uncoated

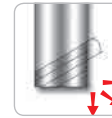

AFA

AFA61431-...

Schaft / Shank DIN 6535HB	d h10	d _A h6	l ₁	l
AFA61431-060	6,0	6,0	16,0	57
AFA61431-070	7,0	8,0	16,0	63
AFA61431-080	8,0	8,0	16,0	63
AFA61431-090	9,0	10,0	19,0	72
AFA61431-100	10,0	10,0	22,0	72
AFA61431-120	12,0	12,0	26,0	83
AFA61431-140	14,0	14,0	26,0	83
AFA61431-160	16,0	16,0	32,0	92
AFA61431-180	18,0	18,0	32,0	92
AFA61431-200	20,0	20,0	38,0	104
AFA61431-250	25,0	25,0	45,0	121

Toleranz / Tolerance (μm)	Nennwertbereich / Diameter range (mm)				
	≥ 1 - 3	> 3 - 6	> 6 - 10	> 10 - 18	> 18 - 30
h10	0 -40	0 -48	0 -58	0 -70	0 -84
h6	0 -6	0 -8	0 -9	0 -11	0 -13

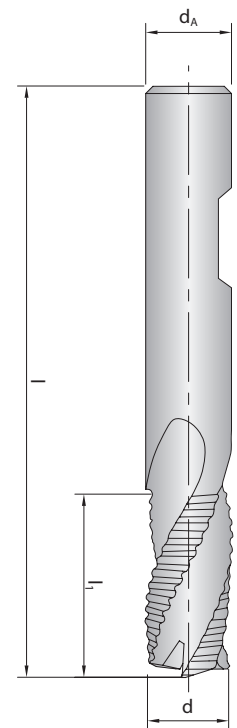

Achtung: Vc -30% bei unbeschichteten Werkzeugen

Attention: Vc -30% with uncoated tools

● = Hauptanwendung / Main application
○ = Nebenanwendung / Suitable

Alle Angaben in mm / Dimensions in mm

VHM-Schruppräser

3 Schneiden, lange Ausführung

Solid carbide roughing end-mill

3 flutes, long design

AFA



3

30°

HA

TiCN

✓

Feinstkorn
Ultra micro
granulation

✓

Seite Page 98-105

P	N	●
M	S	
K	H	

AFA51431-...

Schaft / Shank DIN 6535HA	d js12	d _A h6	l ₁	l
AFA51431-060	6,0	6,0	16,0	57
AFA51431-070	7,0	8,0	16,0	63
AFA51431-080	8,0	8,0	16,0	63
AFA51431-090	9,0	10,0	19,0	72
AFA51431-100	10,0	10,0	22,0	72
AFA51431-120	12,0	12,0	26,0	83
AFA51431-140	14,0	14,0	26,0	83
AFA51431-160	16,0	16,0	32,0	92
AFA51431-180	18,0	18,0	32,0	92
AFA51431-200	20,0	20,0	38,0	104
AFA51431-250	25,0	25,0	45,0	121

Toleranz / Tolerance (μm)	Nennwertbereich / Diameter range (mm)				
	≥ 1 - 3	> 3 - 6	> 6 - 10	> 10 - 18	> 18 - 30
js12	±50	±60	±75	±90	±105
h6	0 -6	0 -8	0 -9	0 -11	0 -13

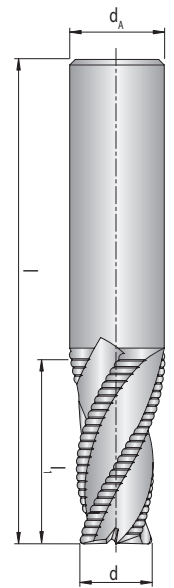

● = Hauptanwendung / Main application
○ = Nebenanwendung / Suitable

VHM-Schrupfräser

3 Schneiden, lange Ausführung

Solid carbide roughing end-mill

3 flutes, long design

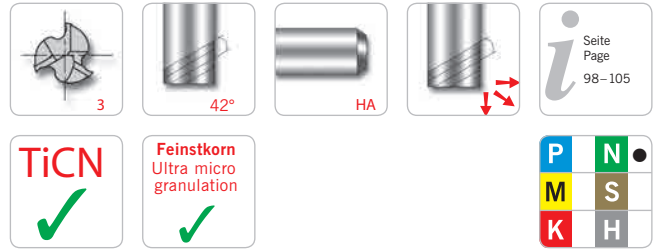

AFA52131-...

Schaft / Shank DIN 6535HA	d js12	d _A h6	l ₁	l ₂	l	Typ/Type
AFA52131-040A	4,0	6,0	6,0	14	60	M
AFA52131-060A	6,0	6,0	10,0	20	65	M
AFA52131-060B	6,0	6,0	18,0	-	60	O
AFA52131-060C	6,0	6,0	30,0	-	70	O
AFA52131-070A	7,0	8,0	20,0	-	65	O
AFA52131-080A	8,0	8,0	12,0	26	80	M
AFA52131-080B	8,0	8,0	20,0	-	65	O
AFA52131-080C	8,0	8,0	30,0	-	100	O
AFA52131-100A	10,0	10,0	14,0	30	85	M
AFA52131-100B	10,0	10,0	26,0	-	70	O
AFA52131-100C	10,0	10,0	40,0	-	100	O
AFA52131-120A	12,0	12,0	16,0	36	100	M
AFA52131-120B	12,0	12,0	30,0	-	80	O
AFA52131-120C	12,0	12,0	50,0	-	120	O
AFA52131-160A	16,0	16,0	20,0	42	110	M
AFA52131-160B	16,0	16,0	40,0	-	100	O
AFA52131-160C	16,0	16,0	56,0	-	120	O
AFA52131-200A	20,0	20,0	24,0	52	110	M
AFA52131-200B	20,0	20,0	46,0	-	100	O
AFA52131-200C	20,0	20,0	60,0	-	120	O

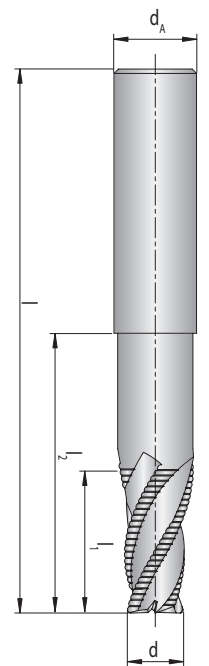

Toleranz / Tolerance (μm)	Nennwertbereich / Diameter range (mm)				
	≥ 1 - 3	> 3 - 6	> 6 - 10	> 10 - 18	> 18 - 30
js12	±50	±60	±75	±90	±105
h6	0 -6	0 -8	0 -9	0 -11	0 -13

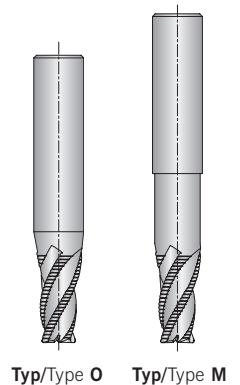

● = Hauptanwendung / Main application
○ = Nebenanwendung / Suitable

Alle Angaben in mm / Dimensions in mm

VHM-Schrupfräser

3 Schneiden, lange Ausführung

Solid carbide roughing end-mill

3 flutes, long design



N NEU/NEW

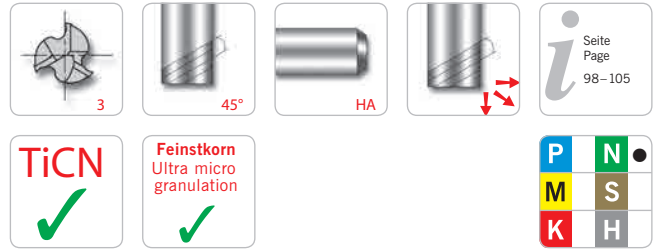

AFA51931-...

Schaft / Shank DIN 6535HA	d h10	d _A h6	l ₁	l
AFA51931-040 N	4,0	6,0	10,0	55
AFA51931-050 N	5,0	6,0	15,0	55
AFA51931-060 N	6,0	6,0	15,0	60
AFA51931-060A N	6,0	6,0	25,0	80
AFA51931-080 N	8,0	8,0	20,0	65
AFA51931-080A N	8,0	8,0	30,0	90
AFA51931-100 N	10,0	10,0	25,0	70
AFA51931-100A N	10,0	10,0	40,0	100
AFA51931-120 N	12,0	12,0	30,0	80
AFA51931-120A N	12,0	12,0	50,0	110
AFA51931-140 N	14,0	16,0	35,0	90
AFA51931-160 N	16,0	16,0	42,0	100
AFA51931-160A N	16,0	16,0	52,0	150
AFA51931-180 N	18,0	20,0	45,0	100
AFA51931-200 N	20,0	20,0	48,0	100
AFA51931-200A N	20,0	20,0	55,0	160

Toleranz / Tolerance (μm)	Nennwertbereich / Diameter range (mm)			
	> 3 - 6	> 6 - 10	> 10 - 18	> 18 - 30
h10	0 -48	0 -58	0 -70	0 -84
h6	0 -8	0 -9	0 -11	0 -13

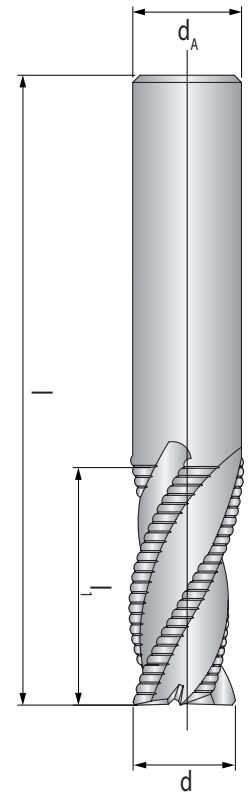

● = Hauptanwendung / Main application
○ = Nebenanwendung / Suitable

Alle Angaben in mm / Dimensions in mm

VHM-Schruppfräser

3 Schneiden, lange Ausführung, abgesetzter Schaft

Solid carbide roughing end-mill

3 flutes, long design, with neck



N NEU/NEW

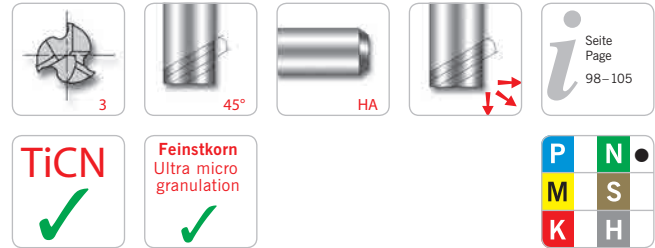

AFA

AFA52331-...

Schaft / Shank DIN 6535HA	d h10	d _A h6	l ₁	l ₂	l
AFA52331-040 N	4,0	6,0	6,0	12	60
AFA52331-050 N	5,0	6,0	7,0	20	60
AFA52331-060 N	6,0	6,0	8,0	20	70
AFA52331-080 N	8,0	8,0	10,0	26	80
AFA52331-100 N	10,0	10,0	12,0	32	90
AFA52331-120 N	12,0	12,0	14,0	36	100
AFA52331-160 N	16,0	16,0	18,0	46	120
AFA52331-200 N	20,0	20,0	22,0	52	120

Toleranz / Tolerance (μm)	Nennwertbereich / Diameter range (mm)			
	> 3 - 6	> 6 - 10	> 10 - 18	> 18 - 30
h10	0 -48	0 -58	0 -70	0 -84
h6	0 -8	0 -9	0 -11	0 -13

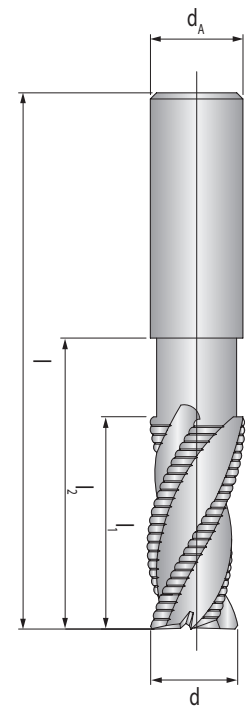

● = Hauptanwendung / Main application
○ = Nebenanwendung / Suitable

Alle Angaben in mm / Dimensions in mm

Empfohlene Schnittwerte VHM-Schafffräser

Ausführung AFA

AFA

ISO	Werkstoff	Festigkeit [N/mm ²]	Vorschub-Korrekturfaktor [x f _z]	Schrupp- und Nutfräsen				Schlicht- und Konturfräsen					
				unbeschichtet	TiAlN	TiCN	Tia70	unbeschichtet	TiAlN	TiCN	Tia70		
				V _c [m/min]	V _c [m/min]	V _c [m/min]	V _c [m/min]	V _c [m/min]	V _c [m/min]	V _c [m/min]	V _c [m/min]		
P	Allgemeiner Baustahl	< 800											
	Automatenstahl	< 800											
	Einsatzstahl, unlegiert	< 800											
	Einsatzstahl, legiert	< 1000											
	Vergütungsstahl, unlegiert	< 850											
	Vergütungsstahl, unlegiert	< 1000											
	Vergütungsstahl, legiert	< 800											
	Vergütungsstahl, legiert	< 1300											
	Stahlguss	< 850											
	Nitrierstahl	< 1000											
	Nitrierstahl	< 1200											
	Wälzlagerstahl	< 1200											
	Federstahl	< 1200											
	Schnellarbeitsstahl	< 1300											
	Werkzeugstahl für Kaltarbeit	< 1300											
Werkzeugstahl für Warmarbeit	< 1300												
M	Stahl und Stahlguss, rostfrei geschwefelt	< 850											
	Nichtrostender Stahl, ferritisch	< 750											
	Nichtrostender Stahl, martensitisch	< 900											
	Nichtrostender Stahl, ferritisch/martensitisch	< 1100											
	Nichtrostender Stahl, austenitisch/ferritisch	< 850											
	Nichtrostender Stahl, austenitisch	< 750											
K	Hitzebeständig	< 1100											
	Grauguss mit Lammellengraphit	100-350											
	Grauguss mit Lammellengraphit	300-1000											
	Kugelgraphitguss	300-500											
	Kugelgraphitguss	550-800											
	Temperguss, weiß	350-450											
	Temperguss, weiß	500-650											
	Temperguss, schwarz	350-450											
Temperguss, schwarz	500-700												
N	Aluminium (unlegiert, niedrig legiert)	< 350	1,9	250-300	280-320	500-550	520-580						
	Aluminiumlegierungen < 0,5% Si	< 500	1,9	250-300	280-320	450-500	500-530						
	Aluminiumlegierungen 0,5 - 10% Si	< 400	1,8	200-250	220-270	400-450	400-480						
	Aluminiumlegierungen 10 - 15% Si	< 400	1,7	150-200	170-200	300-350	300-360						
	Aluminiumlegierungen > 15% Si	< 400	1,6	100-150	120-180	200-250	200-280						
	Kupfer (unlegiert, niedrig legiert)	< 350	1,2	90-120	100-130	160-220	180-240						
	Kupfer-Knetlegierungen	< 700	1,1	80-110	90-120	140-180	160-220						
	Kupfer-Sonderlegierungen	< 200 HB	0,9	100-150	120-160	180-220	200-250						
	Kupfer-Sonderlegierungen	< 300 HB	0,7	70-110	80-120	140-200	160-250						
	Kupfer-Sonderlegierungen	> 300 HB	0,7	60-90	70-100	120-150	140-180						
	Messing kurzspanend, Bronze, Rotguss	< 600	1,1	90-120	100-130	160-220	180-250						
	Messing langspanend	< 600	1,1	90-120	100-130	160-220	180-250						
	Thermoplaste		2	50-60	70-90	100-130	110-140						
	Duroplaste		2	90-100	120-180	180-210	200-250						
	Faserverstärkte Kunststoffe		1	40-60	50-70	80-120	90-140						
	Magnesium und Magnesiumlegierungen	< 850	1,8	100-150	150-200	150-200	170-220						
	Graphit		1	-	100-120	-	150-200						
Wolfram und Wolframlegierungen		1,1	50-80	60-80	70-90	70-100							
Molybdän und Molybdänlegierungen		1	50-80	60-80	70-90	90-100							
S	Reinnickel												
	Nickellegierungen												
	Nickellegierungen	< 850											
	Nickel-Chromlegierungen												
	Nickel- und Kobaltlegierungen	< 1300											
	Hochwarmfeste Legierungen	< 1300											
	Nickel-Kobalt-(Chrom-)legierungen	< 1400											
	Nickel- und Kobaltlegierungen	< 1300											
	Reintitan	< 900											
	Titanlegierungen	< 700											
Titanlegierungen	< 1200												
H	Stahl gehärtet	< 45 HRC											
		46-55 HRC											
		56-60 HRC											
		61-65 HRC											
		65-70 HRC											

Die Tabellenwerte sind Richtwerte. Es kann notwendig sein, die Werte den jeweiligen Bearbeitungsumständen anzupassen.

Recommended cutting data Solid carbide end-mill

Design AFA

ISO	Material	Strength [N/mm ²]	Correction factor [x f _c]	Roughing and full slot milling				Peripheral- and contour milling						
				uncoated	TiAlN	TiCN	Tia70	uncoated	TiAlN	TiCN	Tia70			
				V _c [m/min]	V _c [m/min]	V _c [m/min]	V _c [m/min]	V _c [m/min]	V _c [m/min]	V _c [m/min]	V _c [m/min]			
P	General construction steel	< 800												
	Free cutting steel	< 800												
	Case hardened steel, non alloyed	< 800												
	Alloyed case hardened steel	< 1000												
	Tempering steel, non alloyed	< 850												
	Tempering steel, non alloyed	< 1000												
	Tempering steel, alloyed	< 800												
	Tempering steel, alloyed	< 1300												
	Steel castings	< 850												
	Nitriding steel	< 1000												
	Nitriding steel	< 1200												
	Roller bearing steel	< 1200												
	Spring steel	< 1200												
	High-speed steel	< 1300												
Cold working tool steel	< 1300													
Hot working tool steel	< 1300													
M	Steel and sulphured cast stainless steel	< 850												
	Stainless steel, ferritic	< 750												
	Stainless steel, martensitic	< 900												
	Stainless steel, ferritic/martensitic	< 1100												
	Stainless steel, austenitic/ferritic	< 850												
	Stainless steel, austenitic	< 750												
Heat resistant steel	< 1100													
K	Grey cast iron with lamellar graphite	100-350												
	Grey cast iron with lamellar graphite	300-1000												
	Spheroidal cast iron	300-500												
	Spheroidal cast iron	550-800												
	White cast iron, tempered	350-450												
	White cast iron, tempered	500-650												
	Black cast iron, tempered	350-450												
Black cast iron, tempered	500-700													
N	Aluminium (non alloyed, low alloyed)	< 350	1,9	250-300		280-320		500-550		520-580				
	Aluminium alloys < 0,5% Si	< 500	1,9	250-300		280-320		450-500		500-530				
	Aluminium alloys 0,5% - 10% Si	< 400	1,8	200-250		220-270		400-450		400-480				
	Aluminium alloys 10% - 15% Si	< 400	1,7	150-200		170-200		300-350		300-360				
	Aluminium alloys > 15% Si	< 400	1,6	100-150		120-180		200-250		200-280				
	Copper (non alloyed, low alloyed)	< 350	1,2	90-120		100-130		160-220		180-240				
	Copper wrought alloys	< 700	1,1	80-110		90-120		140-180		160-220				
	Special copper alloys	< 200 HB	0,9	100-150		120-160		180-220		200-250				
	Special copper alloys	< 300 HB	0,7	70-110		80-120		140-200		160-250				
	Special copper alloys	> 300 HB	0,7	60-90		70-100		120-150		140-180				
	Short-chipping brass, bronze, red bronze	< 600	1,1	90-120		100-130		160-220		180-250				
	Long-chipping brass	< 600	1,1	90-120		100-130		160-220		180-250				
	Thermoplastics		2	50-60		70-90		100-130		110-140				
	Duroplastics		2	90-100		120-180		180-210		200-250				
	Fibre-reinforced plastics		1	40-60		50-70		80-120		90-140				
	Magnesium and magnesium alloys	< 850	1,8	100-150		150-200		150-200		170-220				
	Graphite		1	-		100-120		-		150-200				
Tungsten and tungsten alloys		1,1	50-80		60-80		70-90		70-100					
Molybdenum and molybdenum alloys		1	50-80		60-80		70-90		90-100					
S	Pure nickel													
	Nickel alloys													
	Nickel alloys	< 850												
	Nickel-chromium alloys													
	Nickel and cobalt alloys	< 1300												
	Nickel and cobalt alloys	< 1300												
	Heat resistant alloys	< 1400												
	Nickel-cobalt-chromium alloys	< 1300												
	Pure titanium	< 900												
	Titanium alloys	< 700												
Titanium alloys	< 1200													
H	Tempered steel	< 45 HRC												
		46-55 HRC												
		56-60 HRC												
		61-65 HRC												
		65-70 HRC												

AFA

The recommended cutting data are only approximate values. It may be necessary to adjust them to each individual machining application.

Für die nachfolgenden Vorschub-Richtwerte müssen die Werte je nach zu bearbeitendem Material gemäß dem in den Schnittgeschwindigkeitstabellen angegebenen Korrekturfaktor $K_f [f_z]$ korrigiert werden.

For the following feed tables the values must be corrected depending on the material being machined in line with the correction factor $K_f [f_z]$.

AFA

Beispiel für Fräser mit Schneidendurchmesser 6 mm:

An example using a cutter with \varnothing 6 mm is detailed:

Schnittgeschwindigkeits-Tabelle / V_c -table

ISO	Werkstoff / Material	Festigkeit Strength [N/mm ² - HB]	K_f [x f_z]	TiAlN V_c [m/min]
P	Allgemeiner Baustahl General construction steel	< 800 N/mm ²	1,2	100 - 150
	Automatenstahl Free cutting steel	< 800 N/mm ²	1,2	100 - 150
	Einsatzstahl, unlegiert Case hardened steel, non alloyed	< 800 N/mm ²	1,2	100 - 150
	Einsatzstahl, legiert Alloyed case hardened steel	< 1000 N/mm ²	1	90 - 120
	Vergütungsstahl, unlegiert Tempering steel, non alloyed	< 850 N/mm ²	1,2	90 - 130
	Vergütungsstahl, unlegiert Tempering steel, non alloyed	< 1000 N/mm ²	1	60 - 90
	Vergütungsstahl, legiert Tempering steel, alloyed	< 800 N/mm ²	1,2	90 - 120
	Vergütungsstahl, legiert Tempering steel, alloyed	< 1300 N/mm ²	0,8	60 - 80
	Stahlguss Steel castings	< 850 N/mm ²	1,2	70 - 100

Korrekturfaktor-Tabelle / f_z -table

$\varnothing d_1$ [mm]	Korrekturfaktor/ Correction factor $K_f [f_z]$		
	1	0,7	0,8
1	0,004	0,003	0,003
2	0,008	0,006	0,006
3	0,012	0,008	0,010
4	0,016	0,011	0,013
5	0,020	0,014	0,016
6	0,024	0,017	0,019
8	0,032	0,022	0,026

Für legierten Einsatzstahl gilt der Vorschubwert aus der Korrekturfaktor-Tabelle.

$K_f (f_z) = 1$ (entsprechend 100%) $f_z = 0,024$

Für legierten Vergütungsstahl < 1300 N/mm² wird der Vorschubwert aus der Korrekturfaktor-Tabelle um 20% reduziert.

$K_f (f_z) = 0,8$ (entsprechend 80%) $f_z = 0,019$

For case-hardening alloy steel the feed value from the table is valid:

$K_f (f_z) = 1$ (according to 100%) $f_z = 0,024$

For heat treatable steel alloys < 1300 N/mm² the feed value from the table is reduced by 20%.

$K_f (f_z) = 0,8$ (according to 80%) $f_z = 0,019$

Generelle Berechnungsformeln / General rule:

Vorschub pro Zahn / Feed per tooth: = $f_z \cdot K_f (f_z)$

Bohrvorschub (Fräsen in axialer Richtung): = Tabellenwert / Zähnezahl

For axial plunge milling: = Table value / Number of teeth

Vorschub pro Zahn bei einer radialen Zustellung von 0,2 – 0,3 mm

Feed per tooth with radial depth of cut from 0,2 – 0,3 mm

Ø d ₁ [mm]	Korrekturfaktor / Correction factor Kf [f _z]									
	1	0,7	0,8	0,9	1,1	1,2	1,5	1,6	1,8	1,9
1	0,004	0,003	0,003	0,004	0,004	0,005	0,006	0,006	0,007	0,008
2	0,008	0,006	0,006	0,007	0,009	0,010	0,012	0,013	0,014	0,015
3	0,012	0,008	0,010	0,011	0,013	0,014	0,018	0,019	0,022	0,023
4	0,016	0,011	0,013	0,014	0,018	0,019	0,024	0,026	0,029	0,030
5	0,020	0,014	0,016	0,018	0,022	0,024	0,030	0,032	0,036	0,038
6	0,024	0,017	0,019	0,022	0,026	0,029	0,036	0,038	0,043	0,046
8	0,032	0,022	0,026	0,029	0,035	0,038	0,048	0,051	0,058	0,061
10	0,040	0,028	0,032	0,036	0,044	0,048	0,060	0,064	0,072	0,076
12	0,048	0,034	0,038	0,043	0,053	0,058	0,072	0,077	0,086	0,091
14	0,056	0,039	0,045	0,050	0,062	0,067	0,084	0,090	0,101	0,106
16	0,064	0,045	0,051	0,058	0,070	0,077	0,096	0,102	0,115	0,122
18	0,072	0,050	0,058	0,065	0,079	0,086	0,108	0,115	0,130	0,137
20	0,080	0,056	0,064	0,072	0,088	0,096	0,120	0,128	0,144	0,152
25	0,100	0,070	0,080	0,090	0,110	0,120	0,150	0,160	0,180	0,190

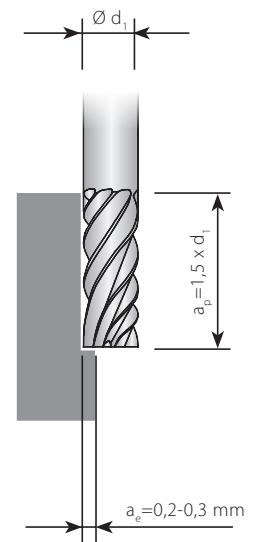

Vorschub pro Zahn bei einer radialen Zustellung 10% vom Schneidendurchmesser (Ø d₁)

Feed per tooth with radial depth of cut of 10% of the cutter (Ø d₁)

Ø d ₁ [mm]	Korrekturfaktor / Correction factor Kf [f _z]									
	1	0,7	0,8	0,9	1,1	1,2	1,5	1,6	1,8	1,9
1	0,003	0,002	0,002	0,003	0,003	0,004	0,005	0,005	0,005	0,006
2	0,008	0,006	0,006	0,007	0,009	0,010	0,012	0,013	0,014	0,015
3	0,012	0,008	0,010	0,011	0,013	0,014	0,018	0,019	0,022	0,023
4	0,014	0,010	0,011	0,013	0,015	0,017	0,021	0,022	0,025	0,027
5	0,017	0,012	0,014	0,015	0,019	0,020	0,026	0,027	0,031	0,032
6	0,020	0,014	0,016	0,018	0,022	0,024	0,030	0,032	0,036	0,038
8	0,027	0,019	0,022	0,024	0,030	0,032	0,041	0,043	0,049	0,051
10	0,033	0,023	0,026	0,030	0,036	0,040	0,050	0,053	0,059	0,063
12	0,040	0,028	0,032	0,036	0,044	0,048	0,060	0,064	0,072	0,076
14	0,047	0,033	0,038	0,042	0,052	0,056	0,071	0,075	0,085	0,089
16	0,053	0,037	0,042	0,048	0,058	0,064	0,080	0,085	0,095	0,101
18	0,060	0,042	0,048	0,054	0,066	0,072	0,090	0,096	0,108	0,114
20	0,067	0,047	0,054	0,060	0,074	0,080	0,101	0,107	0,121	0,127
25	0,083	0,058	0,066	0,075	0,091	0,100	0,125	0,133	0,149	0,158

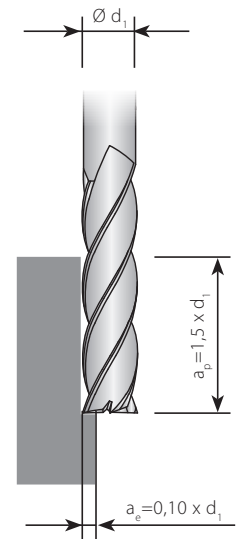

Achtung:

Vorschub-Korrekturfaktor → Kf f_z = 1,10 bei a_p = 1 x d₁ und → Kf f_z = 1,25 bei a_p = 0,5 x d₁
Für unbeschichtete Werkzeuge ist der Vorschub um 10-20% zu reduzieren.

Attention:

Feed rate correction factor → Kf f_z = 1,10 with a_p = 1 x d₁ and → Kf f_z = 1,25 with a_p = 0,5 x d₁
Feed rates are reduced by 10-20% for uncoated tools.

Vorschub pro Zahn bei einer radialen Zustellung 20% vom Schneidendurchmesser ($\varnothing d_1$)
 Feed per tooth with radial depth of cut of 20% of the cutter ($\varnothing d_1$)

$\varnothing d_1$ [mm]	Korrekturfaktor / Correction factor Kf [f _z]									
	1	0,7	0,8	0,9	1,1	1,2	1,5	1,6	1,8	1,9
1	0,002	0,001	0,001	0,001	0,002	0,002	0,003	0,003	0,003	0,003
2	0,005	0,003	0,004	0,004	0,005	0,006	0,007	0,008	0,009	0,009
3	0,008	0,005	0,006	0,007	0,008	0,009	0,012	0,012	0,014	0,015
4	0,010	0,007	0,008	0,009	0,011	0,012	0,015	0,016	0,018	0,019
5	0,013	0,009	0,010	0,011	0,014	0,015	0,019	0,020	0,023	0,024
6	0,015	0,010	0,012	0,013	0,016	0,018	0,022	0,024	0,027	0,028
8	0,020	0,014	0,016	0,018	0,022	0,024	0,030	0,032	0,036	0,038
10	0,025	0,017	0,020	0,022	0,027	0,030	0,037	0,040	0,045	0,047
12	0,030	0,021	0,024	0,027	0,033	0,036	0,045	0,048	0,054	0,057
14	0,035	0,024	0,028	0,031	0,038	0,042	0,052	0,056	0,063	0,066
16	0,040	0,028	0,032	0,036	0,044	0,048	0,060	0,064	0,072	0,076
18	0,045	0,031	0,036	0,040	0,049	0,054	0,067	0,072	0,081	0,085
20	0,050	0,035	0,040	0,045	0,055	0,060	0,075	0,080	0,090	0,095
25	0,063	0,044	0,050	0,056	0,069	0,075	0,094	0,100	0,113	0,119

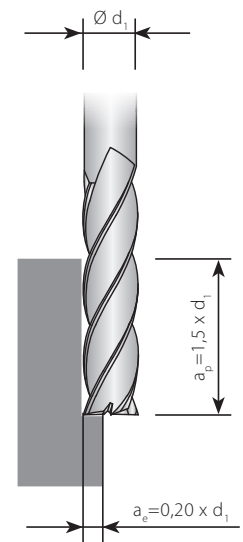

Vorschub pro Zahn bei einer radialen Zustellung 40% vom Schneidendurchmesser ($\varnothing d_1$)
 Feed per tooth with radial depth of cut of 40% of the cutter ($\varnothing d_1$)

$\varnothing d_1$ [mm]	Korrekturfaktor / Correction factor Kf [f _z]									
	1	0,7	0,8	0,9	1,1	1,2	1,5	1,6	1,8	1,9
1	0,001	0,001	0,001	0,001	0,001	0,001	0,002	0,002	0,002	0,003
2	0,004	0,002	0,003	0,003	0,004	0,004	0,006	0,006	0,007	0,007
3	0,006	0,004	0,005	0,005	0,007	0,007	0,009	0,010	0,011	0,012
4	0,008	0,005	0,006	0,007	0,008	0,009	0,012	0,012	0,014	0,015
5	0,010	0,007	0,008	0,009	0,011	0,012	0,015	0,016	0,018	0,019
6	0,012	0,008	0,009	0,010	0,013	0,014	0,018	0,019	0,021	0,022
8	0,016	0,011	0,012	0,014	0,017	0,019	0,024	0,025	0,028	0,030
10	0,020	0,014	0,016	0,018	0,022	0,024	0,030	0,032	0,036	0,038
12	0,024	0,016	0,019	0,021	0,026	0,028	0,036	0,038	0,043	0,045
14	0,028	0,019	0,022	0,025	0,030	0,033	0,042	0,044	0,050	0,053
16	0,032	0,022	0,025	0,028	0,035	0,038	0,048	0,051	0,057	0,060
18	0,036	0,025	0,028	0,032	0,039	0,043	0,054	0,057	0,064	0,068
20	0,040	0,028	0,032	0,036	0,044	0,048	0,060	0,064	0,072	0,076
25	0,050	0,035	0,040	0,045	0,055	0,060	0,075	0,080	0,090	0,095

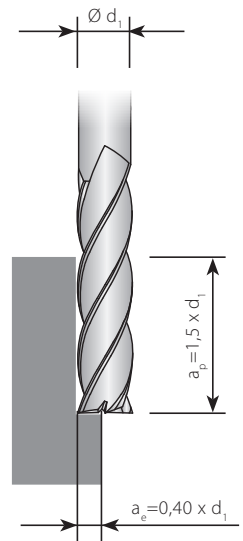

Achtung:
 Vorschub-Korrekturfaktor \rightarrow Kf f_z = 1,10 bei a_p = 1 x d₁ und \rightarrow Kf f_z = 1,25 bei a_p = 0,5 x d₁
 Für unbeschichtete Werkzeuge ist der Vorschub um 10-20% zu reduzieren.

Attention:
 Feed rate correction factor \rightarrow Kf f_z = 1,10 with a_p = 1 x d₁ and \rightarrow Kf f_z = 1,25 with a_p = 0,5 x d₁
 Feed rates are reduced by 10-20% for uncoated tools.

Vorschub pro Zahn bei einer radialen Zustellung 60% vom Schneidendurchmesser ($\varnothing d_1$)

Feed per tooth with radial depth of cut of 60% of the cutter ($\varnothing d_1$)

$\varnothing d_1$ [mm]	Korrekturfaktor / Correction factor $K_f [f_z]$									
	1	0,7	0,8	0,9	1,1	1,2	1,5	1,6	1,8	1,9
1	0,001	0,001	0,001	0,001	0,001	0,001	0,001	0,002	0,002	0,002
2	0,003	0,002	0,002	0,002	0,003	0,003	0,004	0,005	0,005	0,006
3	0,005	0,003	0,004	0,004	0,005	0,006	0,007	0,008	0,009	0,009
4	0,006	0,004	0,005	0,005	0,007	0,007	0,009	0,010	0,011	0,012
5	0,008	0,005	0,006	0,007	0,009	0,010	0,012	0,013	0,015	0,016
6	0,009	0,006	0,007	0,008	0,010	0,011	0,014	0,015	0,017	0,018
8	0,013	0,009	0,010	0,011	0,014	0,015	0,019	0,020	0,023	0,024
10	0,016	0,011	0,013	0,014	0,017	0,019	0,024	0,026	0,029	0,030
12	0,019	0,013	0,015	0,017	0,021	0,023	0,029	0,031	0,035	0,037
14	0,022	0,015	0,018	0,020	0,025	0,027	0,034	0,036	0,040	0,043
16	0,026	0,018	0,020	0,023	0,028	0,031	0,039	0,041	0,046	0,049
18	0,029	0,020	0,023	0,026	0,032	0,035	0,043	0,046	0,052	0,055
20	0,032	0,022	0,026	0,029	0,035	0,039	0,048	0,052	0,058	0,061
25	0,040	0,028	0,032	0,036	0,045	0,049	0,061	0,065	0,073	0,077

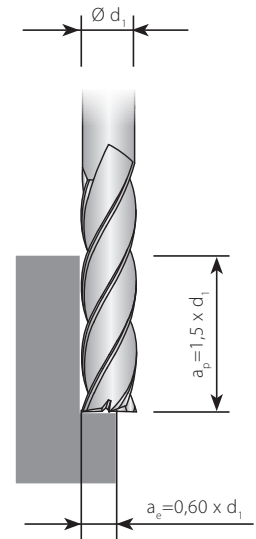

Vorschub pro Zahn bei einer radialen Zustellung 80% vom Schneidendurchmesser ($\varnothing d_1$)

Feed per tooth with radial depth of cut of 80% of the cutter ($\varnothing d_1$)

$\varnothing d_1$ [mm]	Korrekturfaktor / Correction factor $K_f [f_z]$									
	1	0,7	0,8	0,9	1,1	1,2	1,5	1,6	1,8	1,9
1	0,001	0,001	0,001	0,001	0,001	0,001	0,001	0,001	0,001	0,001
2	0,002	0,001	0,002	0,002	0,002	0,003	0,003	0,004	0,004	0,004
3	0,004	0,002	0,003	0,003	0,004	0,004	0,006	0,006	0,007	0,007
4	0,005	0,003	0,004	0,004	0,005	0,006	0,007	0,008	0,009	0,009
5	0,006	0,004	0,005	0,005	0,007	0,007	0,009	0,010	0,011	0,012
6	0,007	0,005	0,006	0,006	0,008	0,009	0,011	0,012	0,013	0,014
8	0,010	0,007	0,008	0,009	0,011	0,012	0,015	0,016	0,018	0,019
10	0,012	0,008	0,010	0,011	0,013	0,015	0,018	0,020	0,022	0,023
12	0,015	0,010	0,012	0,013	0,016	0,018	0,022	0,024	0,027	0,028
14	0,017	0,012	0,014	0,015	0,019	0,021	0,026	0,028	0,031	0,033
16	0,020	0,014	0,016	0,018	0,022	0,024	0,030	0,032	0,036	0,038
18	0,022	0,015	0,018	0,020	0,024	0,027	0,033	0,036	0,040	0,042
20	0,025	0,017	0,020	0,022	0,027	0,030	0,037	0,040	0,045	0,047
25	0,031	0,022	0,025	0,028	0,034	0,037	0,047	0,050	0,056	0,059

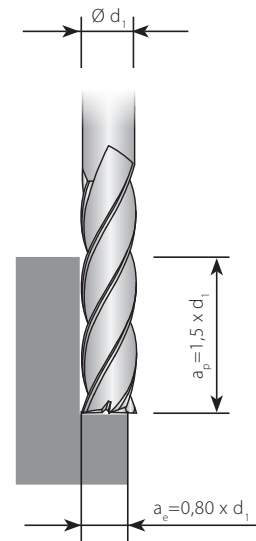

Achtung:

Vorschub-Korrekturfaktor $\rightarrow K_f f_z = 1,10$ bei $a_p = 1 \times d_1$ und $\rightarrow K_f f_z = 1,25$ bei $a_p = 0,5 \times d_1$
 Für unbeschichtete Werkzeuge ist der Vorschub um 10-20% zu reduzieren.

Attention:

Feed rate correction factor $\rightarrow K_f f_z = 1,10$ with $a_p = 1 \times d_1$ and $\rightarrow K_f f_z = 1,25$ with $a_p = 0,5 \times d_1$
 Feed rates are reduced by 10-20% for uncoated tools.

Vorschub pro Zahn beim Vollnutfräsen → $a_p = 0,5 \times d_1$

Feed per tooth when full slot milling → $a_p = 0,5 \times d_1$

AFA

Ø d ₁ [mm]	Korrekturfaktor / Correction factor Kf [f ₁]									
	1	0,7	0,8	0,9	1,1	1,2	1,5	1,6	1,8	1,9
1	0,002	0,001	0,001	0,001	0,002	0,002	0,003	0,003	0,003	0,003
2	0,004	0,002	0,003	0,003	0,004	0,004	0,006	0,006	0,007	0,007
3	0,007	0,004	0,005	0,006	0,007	0,008	0,010	0,011	0,012	0,013
4	0,009	0,006	0,007	0,008	0,009	0,010	0,013	0,014	0,016	0,017
5	0,011	0,007	0,008	0,009	0,012	0,013	0,016	0,017	0,019	0,020
6	0,013	0,009	0,010	0,011	0,014	0,015	0,019	0,020	0,023	0,024
8	0,018	0,012	0,014	0,016	0,019	0,021	0,027	0,028	0,032	0,034
10	0,022	0,015	0,017	0,019	0,024	0,026	0,033	0,035	0,039	0,041
12	0,030	0,021	0,024	0,027	0,033	0,036	0,045	0,048	0,054	0,057
14	0,032	0,022	0,025	0,028	0,035	0,038	0,048	0,051	0,057	0,060
16	0,036	0,025	0,028	0,032	0,039	0,043	0,054	0,057	0,064	0,068
18	0,042	0,029	0,033	0,037	0,046	0,050	0,063	0,067	0,075	0,079
20	0,045	0,031	0,036	0,040	0,049	0,054	0,067	0,072	0,081	0,085
25	0,056	0,039	0,044	0,050	0,061	0,067	0,084	0,089	0,100	0,106

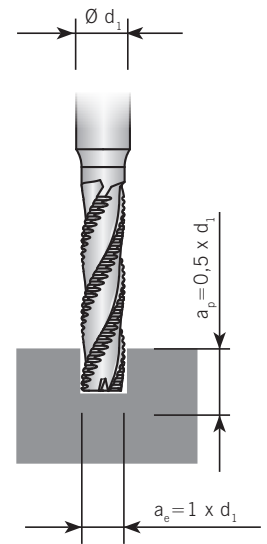

Vorschub pro Zahn beim Vollnutfräsen → $a_p = 1 \times d_1$

Feed per tooth when full slot milling → $a_p = 1 \times d_1$

Ø d ₁ [mm]	Korrekturfaktor / Correction factor Kf [f ₁]									
	1	0,7	0,8	0,9	1,1	1,2	1,5	1,6	1,8	1,9
1	0,001	0,001	0,001	0,001	0,001	0,002	0,002	0,002	0,002	0,002
2	0,003	0,002	0,002	0,002	0,003	0,003	0,004	0,004	0,005	0,005
3	0,005	0,003	0,004	0,004	0,005	0,005	0,007	0,007	0,008	0,009
4	0,006	0,004	0,005	0,005	0,006	0,007	0,009	0,009	0,011	0,011
5	0,007	0,005	0,006	0,006	0,008	0,009	0,011	0,011	0,013	0,014
6	0,008	0,006	0,007	0,008	0,009	0,010	0,013	0,014	0,015	0,016
8	0,012	0,008	0,009	0,011	0,013	0,014	0,018	0,019	0,021	0,022
10	0,014	0,010	0,011	0,013	0,016	0,017	0,021	0,023	0,026	0,027
12	0,020	0,014	0,016	0,018	0,021	0,023	0,029	0,031	0,035	0,037
14	0,021	0,015	0,017	0,019	0,023	0,025	0,031	0,033	0,037	0,040
16	0,023	0,016	0,019	0,021	0,026	0,028	0,035	0,037	0,042	0,044
18	0,027	0,019	0,022	0,025	0,030	0,033	0,041	0,044	0,049	0,052
20	0,029	0,020	0,023	0,026	0,032	0,035	0,044	0,047	0,053	0,056
25	0,036	0,025	0,029	0,033	0,040	0,044	0,055	0,058	0,066	0,069

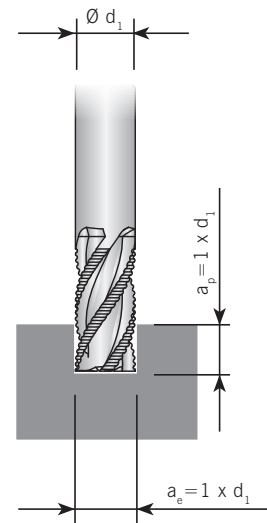

Vorschübe für Vollradius- und Torusfräser
Feed rates for ball nosed- and torus end-mills

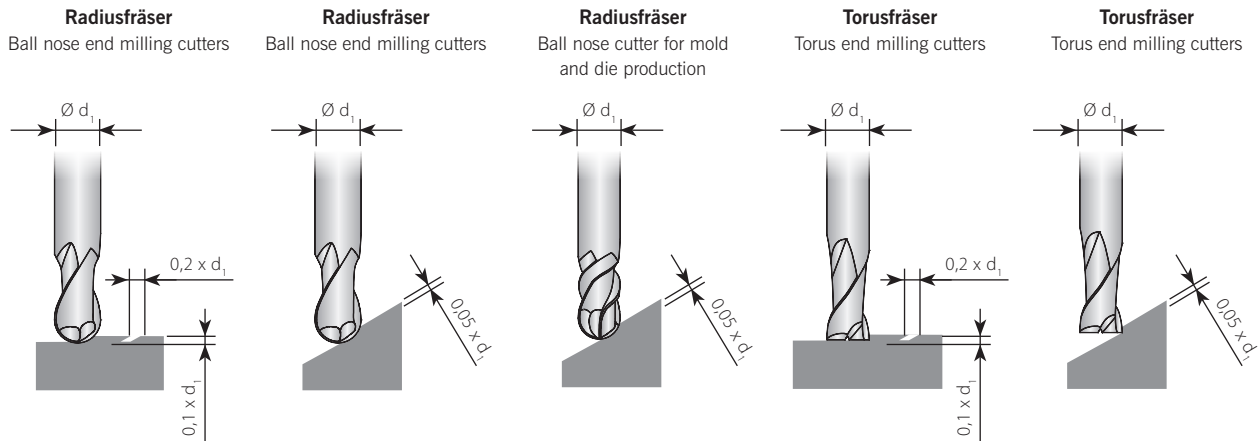

d_1 [mm]	fz [mm]	fz [mm]	fz [mm]	fz [mm]	fz [mm]
2	0,015	0,010	0,005	0,010	0,015
3	0,030	0,020	0,015	0,018	0,020
4	0,040	0,030	0,030	0,025	0,030
5	0,060	0,050	0,050	0,035	0,040
6	0,070	0,060	0,060	0,055	0,060
8	0,100	0,080	0,070	0,075	0,080
10	0,120	0,100	0,080	0,090	0,100
12	0,150	0,120	0,090	0,110	0,120
16	0,180	0,150	0,100	0,135	0,150
18	0,200	0,180	0,110	0,145	0,160
20	0,220	0,200	0,120	0,165	0,180

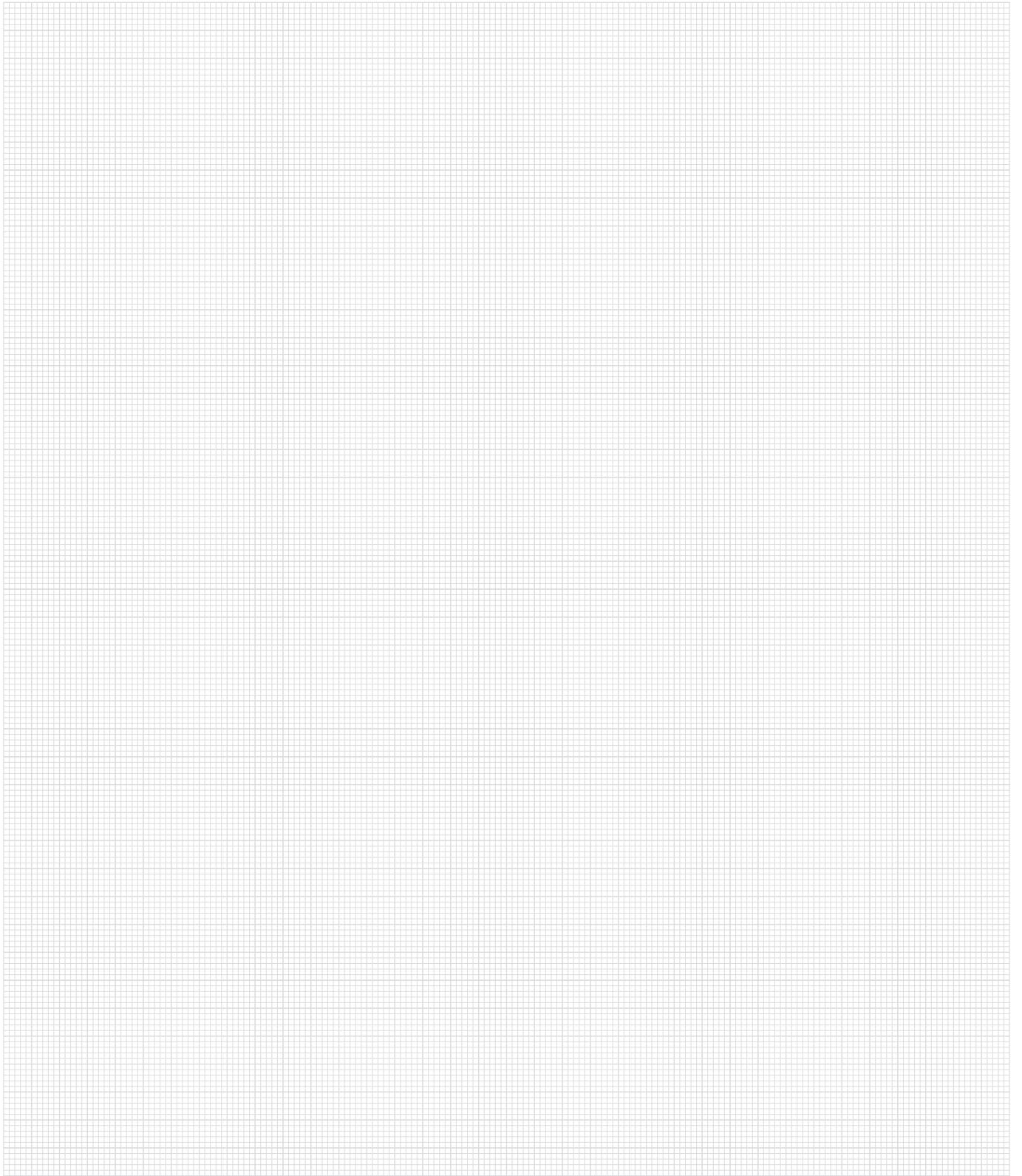

ARNO[®]
WERKZEUGE

Weitere Informationen finden Sie unter:
For more information see:

www.arno.de

ARNO®

WERKZEUGE

We have a passion for precision.

AUSFÜHRUNG AFD

Design AFD

D100 = speziell für die Grafitbearbeitung
DLC = für die Bearbeitung von NE-Metallen

D100 = especially for graphite machining
DLC = for machining of non-ferrous materials

Die hohe Härte der Beschichtung macht die ARNO® AFD Fräser besonders verschleißfest und verbessert die Standzeit. Die ultrafeine Diamantbeschichtung überzeugt durch eine optimale Oberflächengüte und hohe Leistungsfähigkeit.

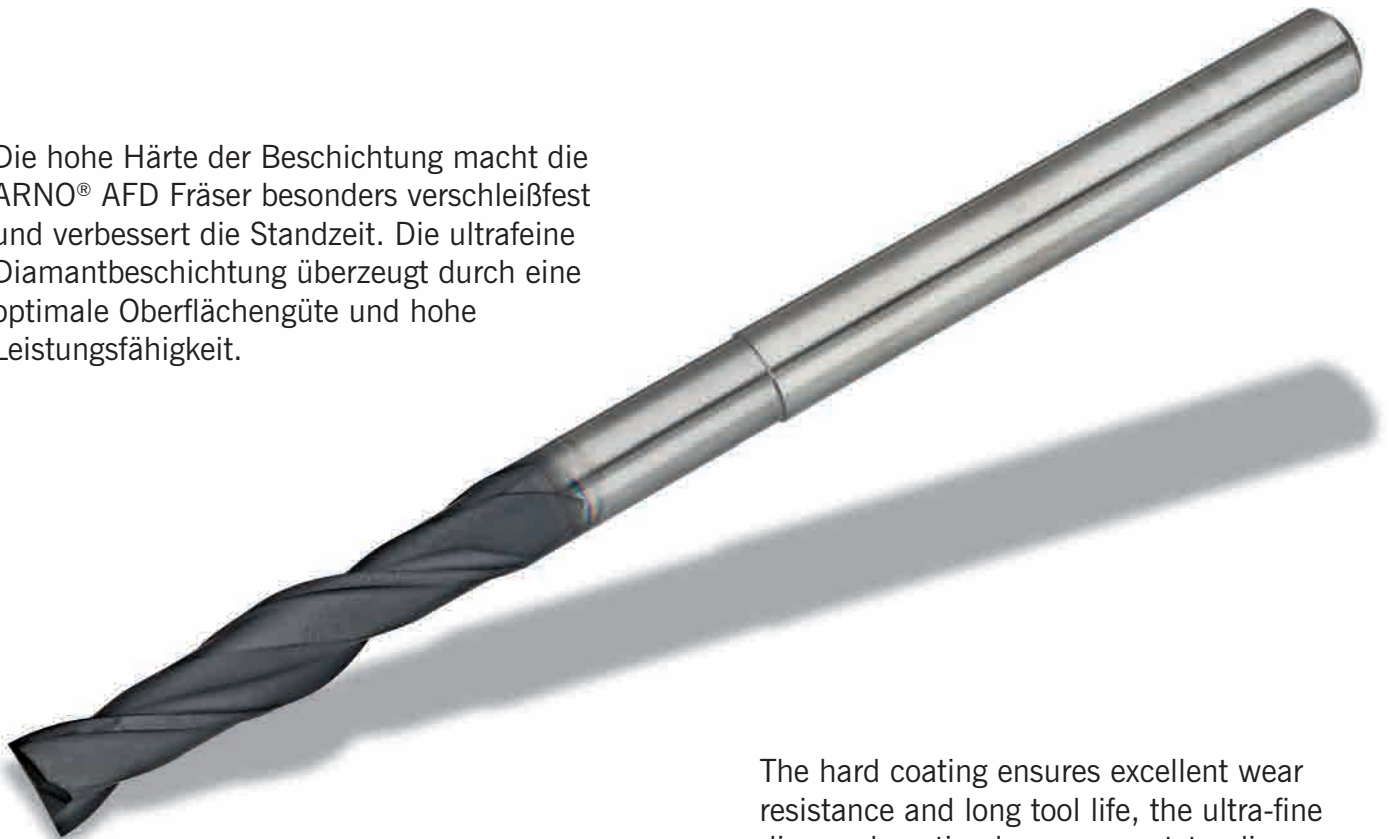

The hard coating ensures excellent wear resistance and long tool life, the ultra-fine diamond coating leaves an outstanding surface finish.

VHM-Schaftfräser

2 Schneiden, Mini-Ausführung mit Eckenradius

Solid carbide end-mill

2 flutes, mini design, with corner radius

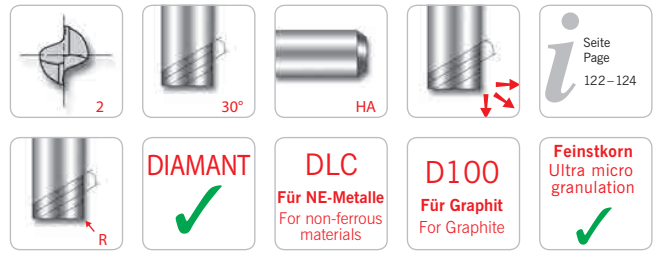

AFD

AFD50724-...R...

Schaft / Shank DIN 6535HA	d	d _A	d ₃	l ₁	l ₂	l	R
AFD50724-002A	0,2	3	-	0,3	-	40	-
AFD50724-003A	0,3	3	-	0,5	-	40	-
AFD50724-004A	0,4	3	-	0,6	-	40	-
AFD50724-005AR0,05	0,5	3	0,45	0,7	2,5	40	0,05
AFD50724-005BR0,05	0,5	3	0,45	0,7	4,0	40	0,05
AFD50724-006AR0,05	0,6	3	0,55	0,9	3,0	40	0,05
AFD50724-006BR0,05	0,6	3	0,55	0,9	5,0	40	0,05
AFD50724-008AR0,05	0,8	3	0,75	1,2	4,0	40	0,05
AFD50724-008BR0,05	0,8	3	0,75	1,2	7,0	40	0,05
AFD50724-010AR0,1	1,0	3	0,95	1,5	5,0	40	0,10
AFD50724-010BR0,1	1,0	3	0,95	1,5	8,5	40	0,10
AFD50724-010CR0,1	1,0	3	0,95	1,5	12,0	40	0,10
AFD50724-012AR0,1	1,2	3	1,15	1,8	6,0	50	0,10
AFD50724-012BR0,1	1,2	3	1,15	1,8	10,0	50	0,10
AFD50724-015AR0,15	1,5	3	1,40	2,2	7,5	50	0,15
AFD50724-015BR0,15	1,5	3	1,40	2,2	12,0	50	0,15
AFD50724-015CR0,15	1,5	3	1,40	2,2	18,0	50	0,15
AFD50724-020AR0,15	2,0	3	1,90	2,2	10,0	60	0,15
AFD50724-020BR0,15	2,0	3	1,90	2,2	16,0	60	0,15
AFD50724-020CR0,15	2,0	3	1,90	2,2	25,0	60	0,15
AFD50724-030AR0,2	3,0	4	2,90	3,0	10,0	65	0,20
AFD50724-030BR0,2	3,0	4	2,90	3,0	15,0	65	0,20
AFD50724-030CR0,2	3,0	4	2,90	3,0	20,0	65	0,20
AFD50724-030DR0,2	3,0	4	2,90	3,0	25,0	75	0,20
AFD50724-030ER0,2	3,0	4	2,90	3,0	30,0	75	0,20
AFD50724-040AR0,2	4,0	6	3,90	4,0	20,0	65	0,20
AFD50724-040BR0,2	4,0	6	3,90	4,0	30,0	75	0,20
AFD50724-040CR0,2	4,0	6	3,90	4,0	40,0	90	0,20
AFD50724-050AR0,3	5,0	6	4,90	5,0	20,0	75	0,30
AFD50724-050BR0,3	5,0	6	4,90	5,0	30,0	75	0,30
AFD50724-050CR0,3	5,0	6	4,90	5,0	40,0	90	0,30
AFD50724-050DR0,3	5,0	6	4,90	5,0	50,0	90	0,30
AFD50724-060AR0,3	6,0	6	5,90	6,0	30,0	75	0,30
AFD50724-060BR0,3	6,0	6	5,90	6,0	40,0	90	0,30
AFD50724-060CR0,3	6,0	6	5,90	6,0	50,0	90	0,30
AFD50724-060DR0,3	6,0	6	5,90	6,0	60,0	100	0,30

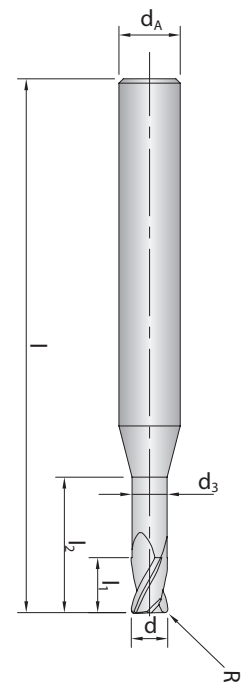

Toleranz / Tolerance	
Fräser / Mill	0 -0,02
Schaft / Shank	h6

D100 = speziell für die Graphitbearbeitung / especially for graphite machining
 DLC = für die Bearbeitung von NE-Metallen / for machining of non-ferrous materials

VHM-Schaftfräser (Schlitzfräsen)

2 Schneiden, mit Eckenradius und konischem Schaftteil



Solid carbide end-mill (Slotting)

2 flutes, with corner radius and taper neck

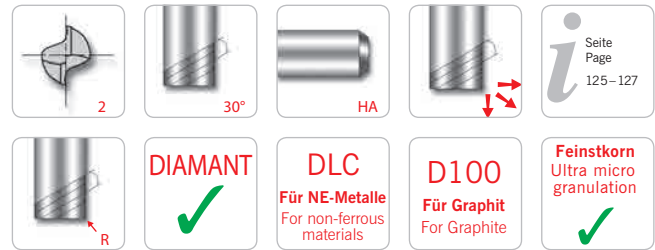

Seite
Page
125-127

AFD

AFD50727-...R...

Schaft / Shank DIN 6535HA	d	d _A	l ₁	l ₂	l	R	A
AFD50727-010AR0,1	1,0	3	2,0	30,0	60	0,10	2°
AFD50727-010BR0,1	1,0	3	2,0	70,0	100	0,10	1°
AFD50727-015AR0,15	1,5	3	3,0	30,0	60	0,15	1°30'
AFD50727-015BR0,15	1,5	3	3,0	50,0	100	0,15	1°
AFD50727-020AR0,15	2,0	3	4,0	30,0	60	0,15	1°
AFD50727-020BR0,15	2,0	4	4,0	70,0	100	0,15	1°

Toleranz / Tolerance	
Fräser / Mill	⁰ -0,02
Schaft / Shank	h6

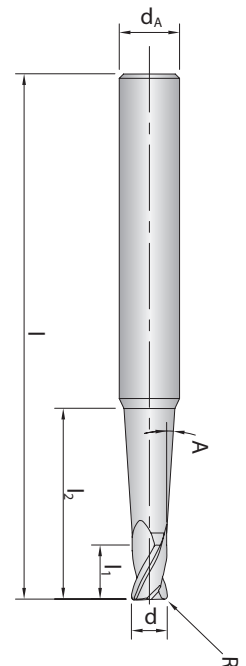

D100 = speziell für die Graphitbearbeitung

DLC = für die Bearbeitung von NE-Metallen

D100 = especially for graphite machining

DLC = for machining of non-ferrous materials

VHM-Schaftfräser

2 Schneiden, lange Ausführung

Solid carbide end-mill

2 flutes, long design

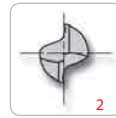

2



30°



HA

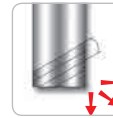

Seite
Page
128-130



DIAMANT



DLC

Für NE-Metalle
For non-ferrous
materials



D100

Für Graphit
For Graphite



Feinstkorn
Ultra micro
granulation



AFD50121-...

Schaft / Shank DIN 6535HA	d	d _A	d ₃	l ₁	l ₂	l
AFD50121-005	0,5	3	0,45	1,0	2,0	40
AFD50121-006	0,6	3	0,55	2,0	3,0	40
AFD50121-007	0,7	3	0,65	2,0	4,0	40
AFD50121-008	0,8	3	0,75	2,0	5,0	40
AFD50121-009	0,9	3	0,85	2,0	6,0	40
AFD50121-010	1,0	4	0,95	3,0	8,0	75
AFD50121-015	1,5	4	1,45	4,0	10,0	75
AFD50121-020	2,0	4	1,90	6,0	16,0	100
AFD50121-025	2,5	4	2,40	8,0	20,0	100
AFD50121-030	3,0	6	2,80	8,0	30,0	100
AFD50121-035	3,5	6	3,20	10,0	35,0	100
AFD50121-040	4,0	6	3,70	20,0	40,0	100
AFD50121-050	5,0	6	4,60	25,0	50,0	125
AFD50121-060	6,0	6	5,60	30,0	60,0	140
AFD50121-070	7,0	6	-	35,0	-	140
AFD50121-080	8,0	8	7,40	40,0	80,0	150
AFD50121-090	9,0	8	-	45,0	-	150
AFD50121-100	10,0	10	9,40	50,0	80,0	150
AFD50121-110	11,0	10	-	50,0	-	150
AFD50121-120	12,0	12	11,40	55,0	80,0	150

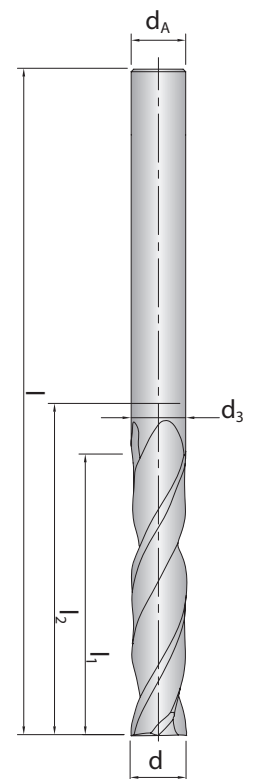

Toleranz / Tolerance	
Fräser / Mill	0 -0,03
Schaft / Shank	h6

D100 = speziell für die Graphitbearbeitung
DLC = für die Bearbeitung von NE-Metallen

D100 = especially for graphite machining
DLC = for machining of non-ferrous materials

VHM-Schaftfräser

2 Schneiden, kurze Ausführung

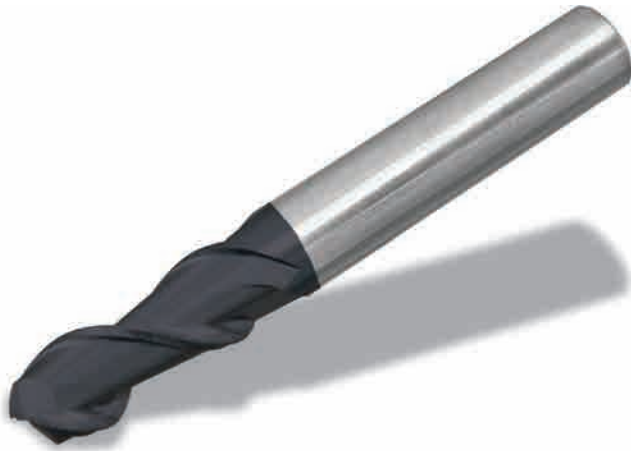

Solid carbide end-mill

2 flutes, short design

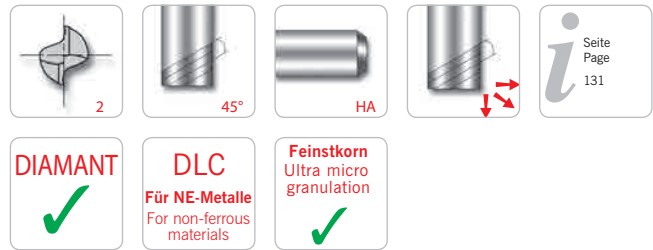

AFD51520-...

Schaft / Shank DIN 6535HA	d	d _A	l ₁	l
AFD51520-010	1,0	4	3,0	40
AFD51520-015	1,5	4	4,0	40
AFD51520-020	2,0	4	6,0	40
AFD51520-025	2,5	4	8,0	40
AFD51520-030	3,0	6	8,0	45
AFD51520-035	3,5	6	10,0	45
AFD51520-040	4,0	6	11,0	45
AFD51520-045	4,5	6	11,0	50
AFD51520-050	5,0	6	13,0	50
AFD51520-055	5,5	6	13,0	50
AFD51520-060	6,0	6	13,0	50
AFD51520-070	7,0	8	16,0	60
AFD51520-080	8,0	8	19,0	60
AFD51520-090	9,0	10	19,0	70
AFD51520-100	10,0	10	22,0	70
AFD51520-110	11,0	12	22,0	75
AFD51520-120	12,0	12	26,0	75
AFD51520-160	16,0	16	32,0	90
AFD51520-200	20,0	20	38,0	100

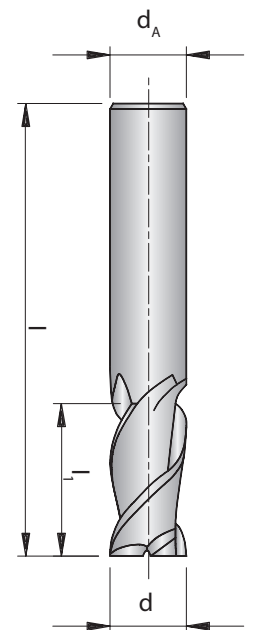

Toleranz / Tolerance	
Fräser / Mill	0 -0,03
Schaft / Shank	h6

DLC = für die Bearbeitung von NE-Metallen

DLC = for machining of non-ferrous materials

VHM-Radiusfräser

2 Schneiden, Mini-Ausführung

Solid carbide ball-nose end-mill

2 flutes, mini design



2

30°

HA

Seite
Page
132-134

DIAMANT

✓

DLC

Für NE-Metalle
For non-ferrous
materials

D100

Für Graphit
For Graphite

Feinstkorn

Ultra micro
granulation

✓

AFD51824-...

Schaft / Shank DIN 6535HA	d	d _A	d ₃	l ₁	l ₂	l	R
AFD51824-002A	0,2	3	-	0,2	-	40	0,10
AFD51824-003A	0,3	3	-	0,3	-	40	0,15
AFD51824-004A	0,4	3	-	0,4	-	40	0,20
AFD51824-005A	0,5	3	0,45	0,5	2,5	40	0,25
AFD51824-006A	0,6	3	0,55	0,6	3,0	40	0,30
AFD51824-006B	0,6	3	0,55	0,6	5,0	40	0,30
AFD51824-008A	0,8	3	0,75	0,8	4,0	40	0,40
AFD51824-008B	0,8	3	0,75	0,8	7,0	40	0,40
AFD51824-010A	1,0	3	0,95	1,0	5,0	40	0,50
AFD51824-010B	1,0	3	0,95	1,0	8,5	40	0,50
AFD51824-010C	1,0	3	0,95	1,0	12,0	40	0,50
AFD51824-012A	1,2	3	1,15	1,2	6,0	50	0,60
AFD51824-012B	1,2	3	1,15	1,2	10,0	50	0,60
AFD51824-015A	1,5	3	1,40	1,5	7,5	50	0,75
AFD51824-015B	1,5	3	1,40	1,5	12,0	50	0,75
AFD51824-015C	1,5	3	1,40	1,5	18,0	50	0,75
AFD51824-020A	2,0	3	1,90	2,2	10,0	60	1,00
AFD51824-020B	2,0	3	1,90	2,2	16,0	60	1,00
AFD51824-020C	2,0	3	1,90	2,2	25,0	60	1,00
AFD51824-030A	3,0	4	2,90	3,0	10,0	65	1,50
AFD51824-030B	3,0	4	2,90	3,0	15,0	65	1,50
AFD51824-030C	3,0	4	2,90	3,0	20,0	65	1,50
AFD51824-030D	3,0	4	2,90	3,0	25,0	75	1,50
AFD51824-030E	3,0	4	2,90	3,0	30,0	75	1,50
AFD51824-040A	4,0	6	3,90	4,0	20,0	65	2,00
AFD51824-040B	4,0	6	3,90	4,0	30,0	75	2,00
AFD51824-040C	4,0	6	3,90	4,0	40,0	90	2,00
AFD51824-050A	5,0	6	4,90	5,0	20,0	65	2,50
AFD51824-050B	5,0	6	4,90	5,0	30,0	75	2,50
AFD51824-050C	5,0	6	4,90	5,0	40,0	90	2,50
AFD51824-050D	5,0	6	4,90	5,0	50,0	90	2,50
AFD51824-060A	6,0	6	5,90	6,0	30,0	75	3,00
AFD51824-060B	6,0	6	5,90	6,0	40,0	90	3,00
AFD51824-060C	6,0	6	5,90	6,0	50,0	90	3,00
AFD51824-060D	6,0	6	5,90	6,0	60,0	100	3,00

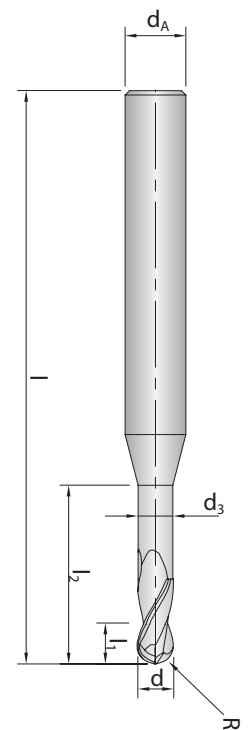

Toleranz / Tolerance	
Fräser / Mill	0 -0,02
Radius / Radius	± 0,01
Schaft / Shank	h6

D100 = speziell für die Graphitbearbeitung / especially for graphite machining
 DLC = für die Bearbeitung von NE-Metallen / for machining of non-ferrous materials

VHM-Radiusfräser

2 Schneiden, Mini-Ausführung

Solid carbide ball-nose end-mill

2 flutes, mini design



2

30°

HA

DIAMANT

✓

D100

Für Graphit
For Graphite

Feinstkorn

Ultra micro
granulation

✓

AFD50325-...

Schaft / Shank DIN 6535HA	d	d _A	d ₃	l ₁	l ₂	l	R
AFD50325-004A	0,4	4	0,36	0,6	4,0	45	0,20
AFD50325-004B	0,4	4	0,36	0,6	6,0	45	0,20
AFD50325-006A	0,6	4	0,56	1,0	4,0	45	0,30
AFD50325-006B	0,6	4	0,56	1,0	6,0	45	0,30
AFD50325-006C	0,6	4	0,56	1,0	8,0	45	0,30
AFD50325-010A	1,0	4	0,95	1,5	6,0	45	0,50
AFD50325-010B	1,0	4	0,95	1,5	8,0	45	0,50
AFD50325-010C	1,0	4	0,95	1,5	12,0	45	0,50
AFD50325-015A	1,5	4	1,45	1,75	12,0	45	0,75
AFD50325-020A	2,0	4	1,95	3,0	8,0	60	1,00
AFD50325-020B	2,0	4	1,95	3,0	12,0	60	1,00
AFD50325-020C	2,0	4	1,95	3,0	16,0	60	1,00
AFD50325-040A	4,0	4	3,90	6,0	16,0	60	2,00

Toleranz / Tolerance	
Fräser / Mill	0 -0,02
Radius / Radius	± 0,01
Schaft / Shank	h6

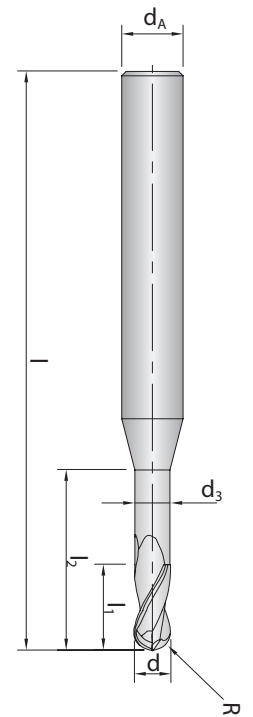

D100 = speziell für die Graphitbearbeitung

D100 = especially for graphite machining

VHM-Radiusfräser

2 Schneiden, mit konischem Schaffteil

Solid carbide ball-nose end-mill

2 flutes, with taper neck







2



30°



HA





Seite
Page
137-139

DIAMANT

✓

DLC

Für NE-Metalle
For non-ferrous
materials

D100

Für Graphit
For Graphite

Feinstkorn

Ultra micro
granulation

✓

AFD51826-...

Schaft / Shank DIN 6535HA	d	d _A	l ₁	l ₂	l	R	A
AFD51826-010A	1,0	3	2,0	-	40	0,50	8°30'
AFD51826-010B	1,0	3	2,0	30,0	60	0,50	2°
AFD51826-010C	1,0	3	2,0	70,0	100	0,50	1°
AFD51826-015A	1,5	3	3,0	-	40	0,75	6°15'
AFD51826-015B	1,5	3	3,0	30,0	60	0,75	1°30'
AFD51826-015C	1,5	3	3,0	58,0	100	0,75	45°
AFD51826-020A	2,0	3	4,0	-	40	1,00	4°15'
AFD51826-020B	2,0	3	4,0	30,0	60	1,00	1°
AFD51826-020C	2,0	4	4,0	70,0	100	1,00	1°

Toleranz / Tolerance	
Fräser / Mill	0 -0,02
Radius / Radius	± 0,01
Schaft / Shank	h6

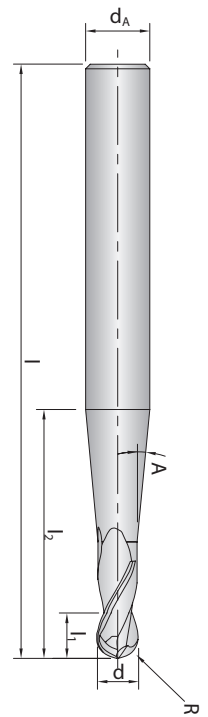

D100 = speziell für die Graphitbearbeitung
 DLC = für die Bearbeitung von NE-Metallen
 D100 = especially for graphite machining
 DLC = for machining of non-ferrous materials

VHM-Radiusfräser

2 Schneiden, lange Ausführung



Solid carbide ball-nose end-mill

2 flutes, long design

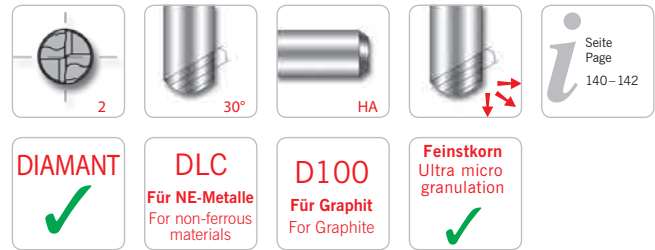

i Seite
Page
140-142

AFD51821-...

Schaft / Shank DIN 6535HA	d	d _A	d ₃	l ₁	l ₂	l	R
AFD51821-020	2,0	4	1,95	10,0	20,0	80	1,00
AFD51821-030	3,0	4	2,90	15,0	25,0	80	1,50
AFD51821-040	4,0	4	3,90	20,0	30,0	80	2,00
AFD51821-050	5,0	6	4,90	30,0	50,0	100	2,50
AFD51821-060	6,0	6	5,50	30,0	50,0	100	3,00
AFD51821-070	7,0	6	5,50	30,0	-	100	3,50
AFD51821-080	8,0	8	7,50	40,0	60,0	110	4,00
AFD51821-090	9,0	8	-	40,0	-	110	4,50
AFD51821-100	10,0	10	9,50	50,0	70,0	120	5,00
AFD51821-120	12,0	12	11,50	55,0	75,0	130	6,00

Toleranz / Tolerance	
Fräser / Mill	0 -0,03
Radius / Radius	± 0,01
Schaft / Shank	h6

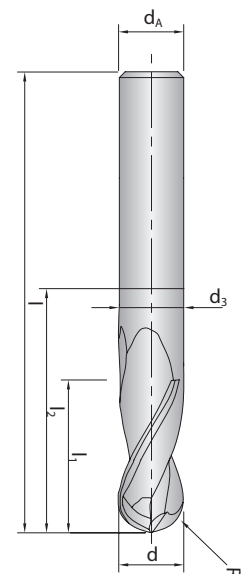

D100 = speziell für die Graphitbearbeitung

DLC = für die Bearbeitung von NE-Metallen

D100 = especially for graphite machining

DLC = for machining of non-ferrous materials

VHM-Radiusfräser

2 Schneiden, überlange Ausführung

Solid carbide ball-nose end-mill

2 flutes, extra long design

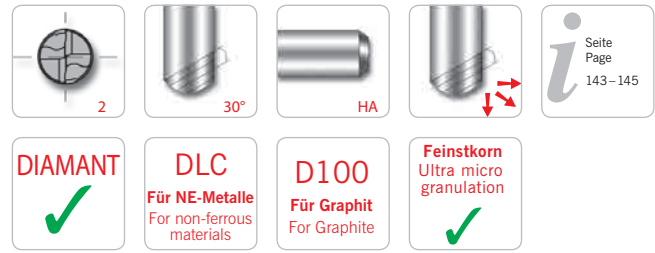

DIAMANT
✓

DLC
Für NE-Metalle
For non-ferrous materials

D100
Für Graphit
For Graphite

Feinstkorn
Ultra micro granulation
✓

AFD

AFD51823-...

Schaft / Shank DIN 6535HA	d	d _A	d ₃	l ₁	l ₂	l	R
AFD51823-020	2,0	4	1,95	10,0	20,0	100	1,00
AFD51823-030	3,0	4	2,90	15,0	25,0	100	1,50
AFD51823-040	4,0	4	3,90	20,0	30,0	100	2,00
AFD51823-050	5,0	6	4,90	30,0	50,0	120	2,50
AFD51823-060	6,0	6	5,50	30,0	50,0	150	3,00
AFD51823-070	7,0	6	-	30,0	-	150	3,50
AFD51823-080	8,0	8	7,50	40,0	60,0	150	4,00
AFD51823-090	9,0	8	-	40,0	-	150	4,50
AFD51823-100	10,0	10	9,50	50,0	70,0	180	5,00
AFD51823-120	12,0	12	11,50	55,0	75,0	200	6,00

Toleranz / Tolerance	
Fräser / Mill	0 -0,03
Radius / Radius	± 0,01
Schaft / Shank	h6

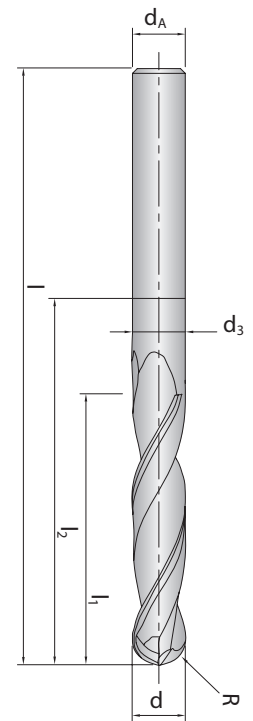

D100 = speziell für die Graphitbearbeitung
DLC = für die Bearbeitung von NE-Metallen

D100 = especially for graphite machining
DLC = for machining of non-ferrous materials

VHM-Radiusfräser

2 Schneiden, kurze Ausführung

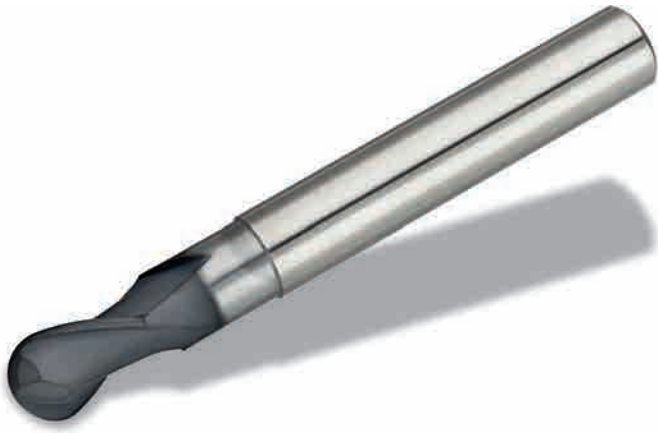

Solid carbide ball-nose end-mill

2 flutes, short design

				<i>i</i> Seite Page 146-148
2	30°	HA		
DIAMANT 	DLC Für NE-Metalle For non-ferrous materials	D100 Für Graphit For Graphite	Feinstkorn Ultra micro granulation 	

AFD51820-...

Schaft / Shank DIN 6535HA	d	d _A	d ₃	l ₁	l ₂	l	R
AFD51820-020	2,0	6	1,90	3,0	5,0	60	1,00
AFD51820-025	2,5	6	2,40	4,0	6,0	60	1,25
AFD51820-030	3,0	6	2,80	4,5	6,5	60	1,50
AFD51820-035	3,5	6	3,20	5,0	7,0	65	1,75
AFD51820-040	4,0	6	3,70	6,0	8,0	65	2,00
AFD51820-050	5,0	6	4,60	7,5	10,0	65	2,50
AFD51820-060	6,0	6	5,60	9,0	12,0	75	3,00
AFD51820-080	8,0	8	7,40	12,0	25,0	75	4,00
AFD51820-100	10,0	10	9,40	15,0	30,0	80	5,00
AFD51820-120	12,0	12	11,40	18,0	36,0	90	6,00

Toleranz / Tolerance	
Fräser / Mill	0 -0,03
Radius / Radius	± 0,01
Schaft / Shank	h6

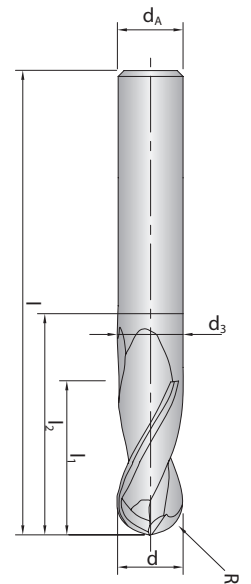

D100 = speziell für die Graphitbearbeitung
 DLC = für die Bearbeitung von NE-Metallen

D100 = especially for graphite machining
 DLC = for machining of non-ferrous materials

VHM-Schaftfräser

3 Schneiden, kurze Ausführung, mit Eckenradius

Solid carbide end-mill

3 flutes, short design, with corner radius

AFD

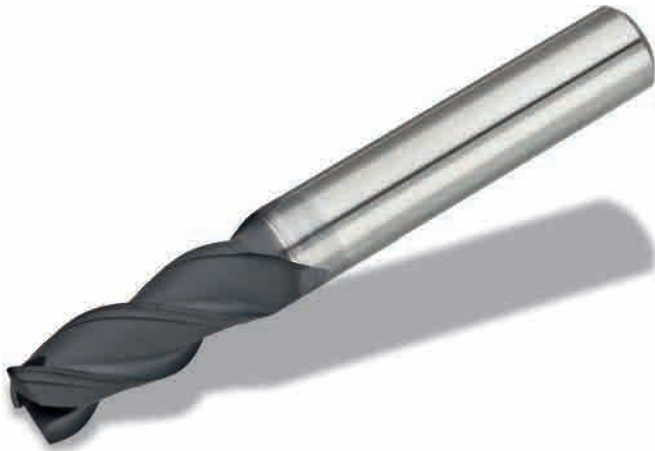



3



40°



HA



D100



Feinstkorn
Ultra micro
granulation



DIAMANT



DLC
Für NE-Metalle
For non-ferrous
materials



D100
Für Graphit
For Graphite



Feinstkorn
Ultra micro
granulation

AFD54030-...R...

Schaft / Shank DIN 6535HA	d	d _A	l ₁	l	R
AFD54030-020R0,15	2,0	3	6,0	40	0,15
AFD54030-030R0,15	3,0	3	12,0	40	0,15
AFD54030-040R0,2	4,0	4	14,0	50	0,20
AFD54030-050R0,3	5,0	5	16,0	50	0,30
AFD54030-060R0,3	6,0	6	20,0	65	0,30
AFD54030-080R0,5	8,0	8	20,0	65	0,50
AFD54030-100R0,5	10,0	10	25,0	75	0,50
AFD54030-120R0,5	12,0	12	25,0	75	0,50

Toleranz / Tolerance	
Fräser / Mill	0 -0,03
Schaft / Shank	h6

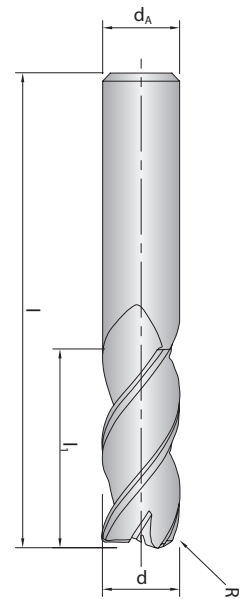

D100 = speziell für die Graphitbearbeitung
 DLC = für die Bearbeitung von NE-Metallen
 D100 = especially for graphite machining
 DLC = for machining of non-ferrous materials

VHM-Schaftfräser

3 Schneiden, lange Ausführung, mit Eckenradius

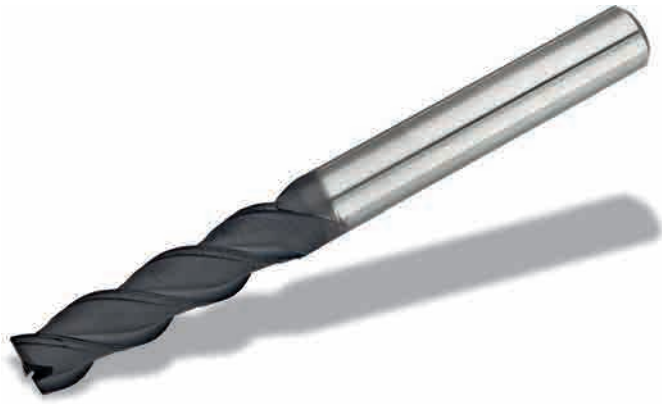

Solid carbide end-mill

3 flutes, long design, with corner radius

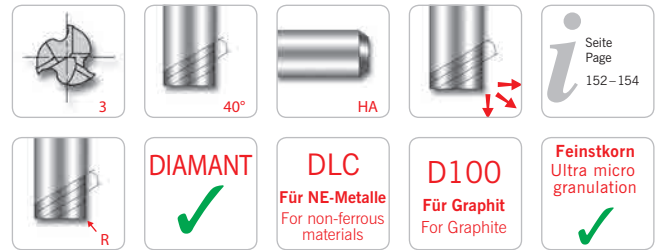

AFD54031-...R...

Schaft / Shank DIN 6535HA	d	d _A	l ₁	l	R
AFD54031-020R0,15	2,0	3	9,0	60	0,15
AFD54031-030R0,15	3,0	3	30,0	60	0,15
AFD54031-040R0,2	4,0	4	30,0	60	0,20
AFD54031-050R0,3	5,0	5	35,0	70	0,30
AFD54031-060R0,3	6,0	6	40,0	100	0,30
AFD54031-080R0,5	8,0	8	40,0	100	0,50
AFD54031-100R0,5	10,0	10	40,0	100	0,50
AFD54031-120R0,5	12,0	12	45,0	100	0,50

Toleranz / Tolerance	
Fräser / Mill	0 -0,03
Schaft / Shank	h6

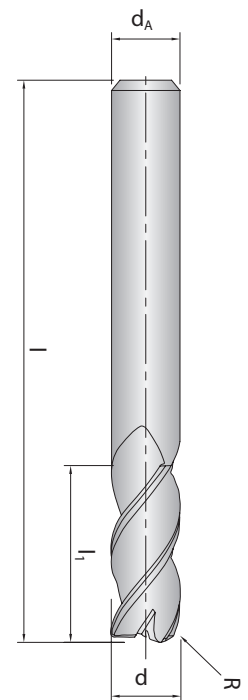

D100 = speziell für die Graphitbearbeitung

DLC = für die Bearbeitung von NE-Metallen

D100 = especially for graphite machining

DLC = for machining of non-ferrous materials

VHM-Radiusfräser





3 Schneiden, kurze Ausführung

Solid carbide ball-nose end-mill

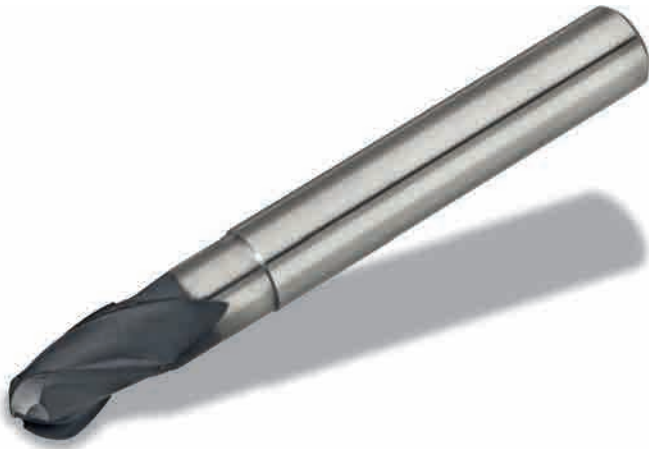
3 flutes, short design

AFD



 3	 30°	 HA	 Feinstkorn Ultra micro granulation	 Seite Page 155-157
DIAMANT ✓	DLC Für NE-Metalle For non-ferrous materials	D100 Für Graphit For Graphite	✓	

AFD51830-...

Schaft / Shank DIN 6535HA	d	d _A	d ₃	l ₁	l ₂	l	R
AFD51830-020	2,0	6	1,90	3,0	5,0	60	1,00
AFD51830-025	2,5	6	2,40	4,0	6,0	60	1,25
AFD51830-030	3,0	6	2,80	4,5	6,5	60	1,50
AFD51830-035	3,5	6	3,20	5,0	7,0	65	1,75
AFD51830-040	4,0	6	3,70	6,0	8,0	65	2,00
AFD51830-050	5,0	6	4,60	7,5	10,0	65	2,50
AFD51830-060	6,0	6	5,60	9,0	12,0	75	3,00
AFD51830-080	8,0	8	7,40	12,0	25,0	75	4,00
AFD51830-100	10,0	10	9,40	15,0	30,0	80	5,00
AFD51830-120	12,0	12	11,40	18,0	36,0	90	6,00

Toleranz / Tolerance	
Fräser / Mill	0 -0,03
Radius / Radius	± 0,01
Schaft / Shank	h6

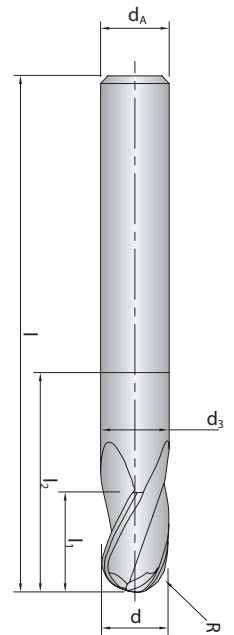

D100 = speziell für die Graphitbearbeitung
 DLC = für die Bearbeitung von NE-Metallen
 D100 = especially for graphite machining
 DLC = for machining of non-ferrous materials

VHM-Schaftfräser

4 Schneiden, mit Eckenradius

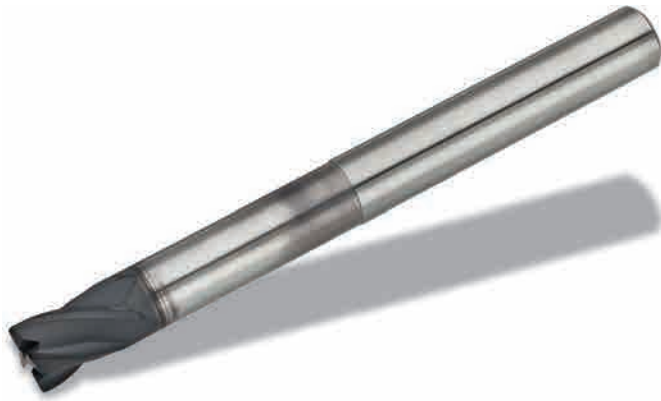

Solid carbide end-mill

4 flutes, with corner radius

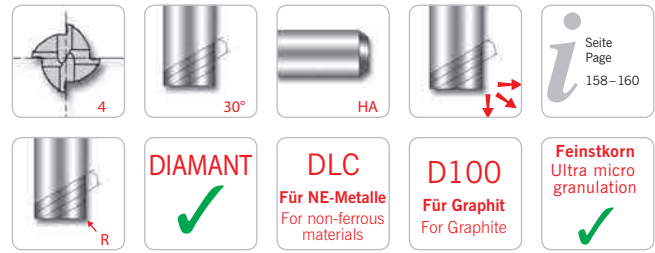

AFD50740-...R...

Schaft / Shank DIN 6535HA	d	d _A	d ₃	l ₁	l ₂	l	R
AFD50740-060AR0,5	6,0	6	5,90	10,0	40,0	80	0,50
AFD50740-080AR0,5	8,0	8	7,80	10,0	40,0	80	0,50
AFD50740-080BR1,0	8,0	8	7,80	10,0	60,0	100	1,00
AFD50740-100AR0,5	10,0	10	-	25,0	-	75	0,50
AFD50740-100BR0,5	10,0	10	9,80	12,0	40,0	80	0,50
AFD50740-100CR1,0	10,0	10	9,80	12,0	40,0	80	1,00
AFD50740-100DR0,5	10,0	10	9,80	12,0	80,0	125	0,50
AFD50740-120AR0,5	12,0	12	-	25,0	-	80	0,50
AFD50740-120BR0,5	12,0	12	11,80	15,0	40,0	80	0,50
AFD50740-120CR1,0	12,0	12	11,80	15,0	40,0	80	1,00
AFD50740-120DR1,0	12,0	12	11,80	15,0	80,0	125	1,00

Toleranz / Tolerance	
Fräser / Mill	0 -0,03
Schaft / Shank	h6

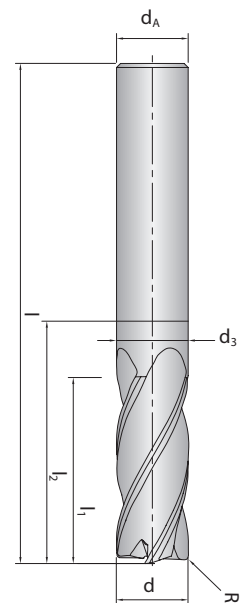

D100 = speziell für die Graphitbearbeitung

DLC = für die Bearbeitung von NE-Metallen

D100 = especially for graphite machining

DLC = for machining of non-ferrous materials

AFD50724-...

D100-Beschichtung für Graphitbearbeitung

D100 coating for graphite machining

AFD

Ø d ₁ [mm]	Z	fz [mm]	n 15000 min1 vf [mm/min.]	n 25000 min1 vf [mm/min.]	n 30000 min1 vf [mm/min.]	n 45000 min1 vf [mm/min.]
0,2	2	0,004	120	200	240	360
0,3	2	0,005	150	250	300	450
0,4	2	0,005	150	250	300	450
0,5	2	0,006	180	300	360	540
0,6	2	0,007	210	350	420	630
0,8	2	0,009	270	450	540	810
1,0	2	0,012	360	600	720	1080
1,2	2	0,015	450	750	900	1350
1,5	2	0,018	540	900	1080	1620
2,0	2	0,024	720	1200	1440	2160
3,0	2	0,035	1050	1750	2100	3150
4,0	2	0,047	1410	2350	2820	4230
5,0	2	0,059	1770	2950	3540	5310
6,0	2	0,071	2130	3550	4260	6390

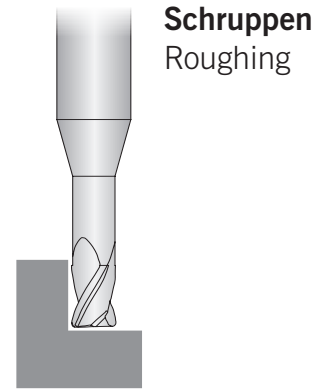

Ø d ₁ [mm]	Z	fz [mm]	n 15000 min1 vf [mm/min.]	n 25000 min1 vf [mm/min.]	n 30000 min1 vf [mm/min.]	n 45000 min1 vf [mm/min.]
0,2	2	0,004	120	200	240	360
0,3	2	0,004	120	200	240	360
0,4	2	0,004	120	200	240	360
0,5	2	0,005	150	250	300	450
0,6	2	0,005	150	250	300	450
0,8	2	0,007	210	350	420	630
1,0	2	0,009	270	450	540	810
1,2	2	0,011	330	550	660	990
1,5	2	0,014	420	700	840	1260
2,0	2	0,018	540	900	1080	1620
3,0	2	0,027	810	1350	1620	2430
4,0	2	0,036	1080	1800	2160	3240
5,0	2	0,045	1350	2250	2700	4050
6,0	2	0,055	1650	2750	3300	4950

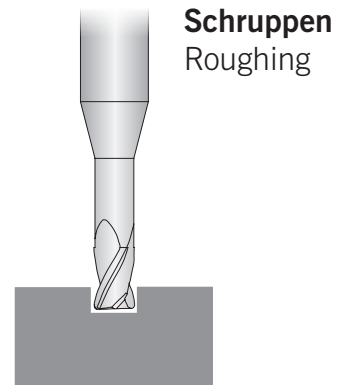

Achtung:
Die angegebenen Schnittparameter sind Richt- und Startwerte.
Kundenspezifische Gegebenheiten wie Antriebsleistung, Maschinenstabilität,
Werkzeugauskragung etc. sind hierbei nicht berücksichtigt.

Attention:
These cutting data are recommendations only.
Customer specific circumstances such as machine power, stability,
tool overhang etc. are not taken into consideration.

AFD50724-...

D100-Beschichtung für Graphitbearbeitung

D100 coating for graphite machining

Ø d ₁ [mm]	Z	fz [mm]	n 15000 min1 vf [mm/min.]	n 25000 min1 vf [mm/min.]	n 30000 min1 vf [mm/min.]	n 45000 min1 vf [mm/min.]
0,2	2	0,004	120	200	240	360
0,3	2	0,004	120	200	240	360
0,4	2	0,005	150	250	300	450
0,5	2	0,007	210	350	420	630
0,6	2	0,008	240	400	480	720
0,8	2	0,011	330	550	660	990
1,0	2	0,013	390	650	780	1170
1,2	2	0,015	450	750	900	1350
1,5	2	0,020	600	1000	1200	1800
2,0	2	0,027	810	1350	1620	2430
3,0	2	0,040	1200	2000	2400	3600
4,0	2	0,053	1590	2650	3180	4770
5,0	2	0,067	2010	3350	4020	6030
6,0	2	0,080	2400	4000	4800	7200

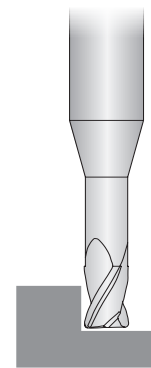

Schlichten
Finishing

AFD

Ø d ₁ [mm]	Z	fz [mm]	n 15000 min1 vf [mm/min.]	n 25000 min1 vf [mm/min.]	n 30000 min1 vf [mm/min.]	n 45000 min1 vf [mm/min.]
0,2	2	0,004	120	200	240	360
0,3	2	0,004	120	200	240	360
0,4	2	0,005	150	250	300	450
0,5	2	0,007	210	350	420	630
0,6	2	0,008	240	400	480	720
0,8	2	0,011	330	550	660	990
1,0	2	0,013	390	650	780	1170
1,2	2	0,015	450	750	900	1350
1,5	2	0,020	600	1000	1200	1800
2,0	2	0,027	810	1350	1620	2430
3,0	2	0,040	1200	2000	2400	3600
4,0	2	0,053	1590	2650	3180	4770
5,0	2	0,067	2010	3350	4020	6030
6,0	2	0,080	2400	4000	4800	7200

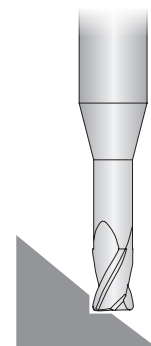

Schlichten
Finishing

Achtung:
Die angegebenen Schnittparameter sind Richt- und Startwerte.
Kundenspezifische Gegebenheiten wie Antriebsleistung, Maschinenstabilität,
Werkzeugauskragung etc. sind hierbei nicht berücksichtigt.

Attention:
These cutting data are recommendations only.
Customer specific circumstances such as machine power, stability,
tool overhang etc. are not taken into consideration.

AFD50724-...

DLC-Beschichtung für Aluminiumlegierungen

DLC coating for aluminium alloys

Ø d ₁ [mm]	Z	V _c m/min.	f _z [mm]	n [U/min ¹]	vf [mm/min.]
0,5	2	50	0,002	32000	130
1,0	2	100	0,003	32000	190
1,5	2	150	0,005	32000	320
2,0	2	170	0,007	27000	380
3,0	2	190	0,016	20000	640
4,0	2	190	0,022	15000	660
5,0	2	190	0,029	12000	700
6,0	2	190	0,039	10000	780

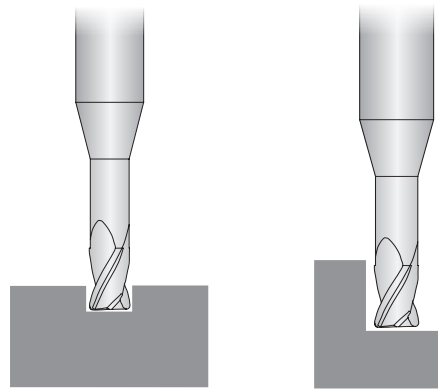

AFD

DLC-Beschichtung für Kupferlegierungen

DLC coating for copper alloys

Ø d ₁ [mm]	Z	V _c m/min.	f _z [mm]	n [U/min ¹]	vf [mm/min.]
0,5	2	50	0,002	32000	130
1,0	2	75	0,003	25000	150
1,5	2	75	0,005	16000	160
2,0	2	75	0,007	12000	170
3,0	2	80	0,012	8500	210
4,0	2	80	0,025	6400	320
5,0	2	80	0,033	5100	340
6,0	2	80	0,040	4300	350

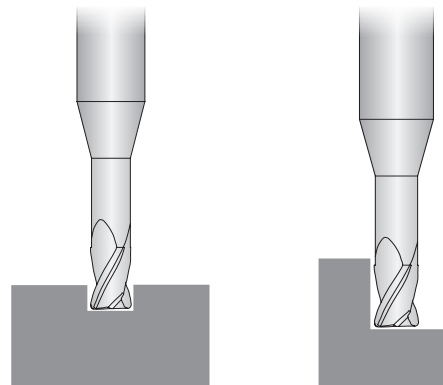

Achtung:
Die angegebenen Schnittparameter sind Richt- und Startwerte.
Kundenspezifische Gegebenheiten wie Antriebsleistung, Maschinenstabilität,
Werkzeugauskragung etc. sind hierbei nicht berücksichtigt.

Attention:
These cutting data are recommendations only.
Customer specific circumstances such as machine power, stability,
tool overhang etc. are not taken into consideration.

AFD50727-...

D100-Beschichtung für Graphitbearbeitung

D100 coating for graphite machining

Ø d ₁ [mm]	Z	fz [mm]	n 15000 min1 vf [mm/min.]	n 25000 min1 vf [mm/min.]	n 30000 min1 vf [mm/min.]	n 45000 min1 vf [mm/min.]
1,0	2	0,012	360	600	720	1080
1,5	2	0,018	540	900	1080	1620
2,0	2	0,024	720	1200	1440	2160

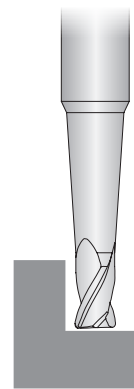

Schruppen
Roughing

AFD

Ø d ₁ [mm]	Z	fz [mm]	n 15000 min1 vf [mm/min.]	n 25000 min1 vf [mm/min.]	n 30000 min1 vf [mm/min.]	n 45000 min1 vf [mm/min.]
1,0	2	0,009	270	450	540	810
1,5	2	0,014	420	700	840	1260
2,0	2	0,018	540	900	1082	1620

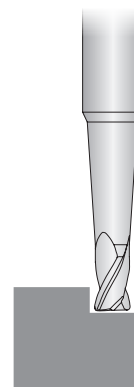

Schruppen
Roughing

Achtung:
Die angegebenen Schnittparameter sind Richt- und Startwerte.
Kundenspezifische Gegebenheiten wie Antriebsleistung, Maschinenstabilität,
Werkzeugauskragung etc. sind hierbei nicht berücksichtigt.

Attention:
These cutting data are recommendations only.
Customer specific circumstances such as machine power, stability,
tool overhang etc. are not taken into consideration.

Alle Angaben in mm / Dimensions in mm

AFD50727-...

D100-Beschichtung für Graphitbearbeitung

D100 coating for graphite machining

AFD

Ø d ₁ [mm]	Z	fz [mm]	n 15000 min1 vf [mm/min.]	n 25000 min1 vf [mm/min.]	n 30000 min1 vf [mm/min.]	n 45000 min1 vf [mm/min.]
1,0	2	0,013	390	650	780	1170
1,5	2	0,020	600	1000	1200	1800
2,0	2	0,027	810	1350	1620	2430



Ø d ₁ [mm]	Z	fz [mm]	n 15000 min1 vf [mm/min.]	n 25000 min1 vf [mm/min.]	n 30000 min1 vf [mm/min.]	n 45000 min1 vf [mm/min.]
1,0	2	0,013	390	650	780	1170
1,5	2	0,020	600	1000	1200	1800
2,0	2	0,027	810	1350	1620	2430

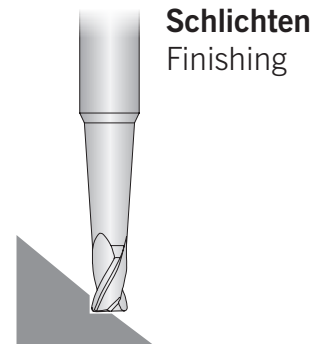

Achtung:
Die angegebenen Schnittparameter sind Richt- und Startwerte.
Kundenspezifische Gegebenheiten wie Antriebsleistung, Maschinenstabilität,
Werkzeugauskragung etc. sind hierbei nicht berücksichtigt.

Attention:
These cutting data are recommendations only.
Customer specific circumstances such as machine power, stability,
tool overhang etc. are not taken into consideration.

AFD50727-...

DLC-Beschichtung für Aluminiumlegierungen

DLC coating for aluminium alloys

Ø d ₁ [mm]	Z	V _c m/min.	f _z [mm]	n [U/min ¹]	vf [mm/min.]
1,0	2	100	0,004	32000	250
1,5	2	150	0,005	32000	320
2,0	2	170	0,007	27000	380

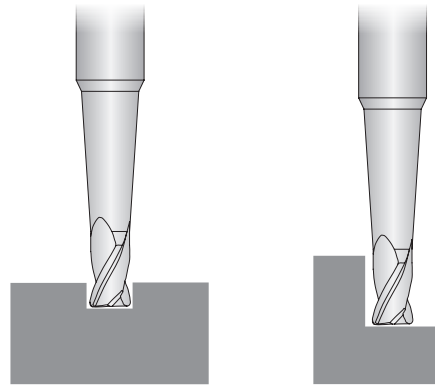

AFD

DLC-Beschichtung für Kupferlegierungen

DLC coating for copper alloys

Ø d ₁ [mm]	Z	V _c m/min.	f _z [mm]	n [U/min ¹]	vf [mm/min.]
1,0	2	78	0,004	25000	180
1,5	2	75	0,006	16000	190
2,0	2	75	0,008	12000	200

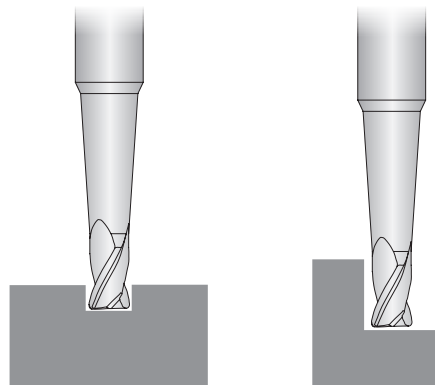

Achtung:

Die angegebenen Schnittparameter sind Richt- und Startwerte. Kundenspezifische Gegebenheiten wie Antriebsleistung, Maschinenstabilität, Werkzeugauskragung etc. sind hierbei nicht berücksichtigt.

Attention:

These cutting data are recommendations only. Customer specific circumstances such as machine power, stability, tool overhang etc. are not taken into consideration.

Alle Angaben in mm / Dimensions in mm

AFD50121-...

D100-Beschichtung für Graphitbearbeitung

D100 coating for graphite machining

AFD

Ø d ₁ [mm]	Z	fz [mm]	n 15000 min1 vf [mm/min.]	n 25000 min1 vf [mm/min.]	n 30000 min1 vf [mm/min.]	n 45000 min1 vf [mm/min.]
0,5	2	0,005	150	250	300	450
0,6	2	0,006	180	300	360	540
0,7	2	0,007	210	350	420	630
0,8	2	0,008	240	400	480	720
0,9	2	0,008	240	400	480	720
1,0	2	0,009	270	450	540	810
1,5	2	0,014	420	700	840	1260
2,0	2	0,019	570	950	1140	1710
2,5	2	0,024	720	1200	1440	2160
3,0	2	0,029	840	1400	1680	2520
3,5	2	0,032	960	1600	1920	2880
4,0	2	0,040	1200	2000	2400	3600
5,0	2	0,045	1350	2250	2700	4050
6,0	2	0,050	1500	2500	3000	4500
7,0	2	0,055	1650	2750	3300	4950
8,0	2	0,060	1800	3000	3600	5400
9,0	2	0,065	1950	3250	3900	5850
10,0	2	0,070	2100	3500	4200	6300
11,0	2	0,075	2250	3750	4500	6750
12,0	2	0,080	2400	4000	4800	7200



Schruppen
Roughing

Ø d ₁ [mm]	Z	fz [mm]	n 15000 min1 vf [mm/min.]	n 25000 min1 vf [mm/min.]	n 30000 min1 vf [mm/min.]	n 45000 min1 vf [mm/min.]
0,5	2	0,003	90	150	180	270
0,6	2	0,003	90	150	180	270
0,7	2	0,003	90	150	180	270
0,8	2	0,004	120	200	240	360
0,9	2	0,005	150	250	300	450
1,0	2	0,005	150	250	300	450
1,5	2	0,008	240	400	480	720
2,0	2	0,011	330	550	660	990
2,5	2	0,014	420	700	840	1260
3,0	2	0,016	480	800	960	1440
3,5	2	0,019	570	950	1140	1710
4,0	2	0,021	630	1050	1260	1890
5,0	2	0,026	780	1300	1560	2340
6,0	2	0,031	930	1550	1860	2790
7,0	2	0,036	1080	1800	2160	3240
8,0	2	0,040	1200	2000	2400	3600
9,0	2	0,045	1350	2250	2700	4050
10,0	2	0,050	1500	2500	3000	4500
11,0	2	0,055	1650	2750	3300	4950
12,0	2	0,060	1800	3000	3600	5400

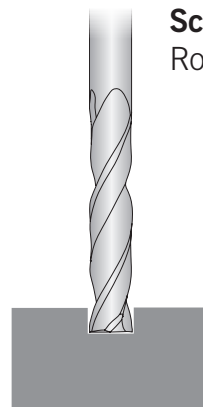

Schruppen
Roughing

Achtung:
Die angegebenen Schnittparameter sind Richt- und Startwerte.
Kundenspezifische Gegebenheiten wie Antriebsleistung, Maschinenstabilität,
Werkzeugauskragung etc. sind hierbei nicht berücksichtigt.

Attention:
These cutting data are recommendations only.
Customer specific circumstances such as machine power, stability,
tool overhang etc. are not taken into consideration.

AFD50121-...

D100-Beschichtung für Graphitbearbeitung

D100 coating for graphite machining

Ø d ₁ [mm]	Z	fz [mm]	n 15000 min1 vf [mm/min.]	n 25000 min1 vf [mm/min.]	n 30000 min1 vf [mm/min.]	n 45000 min1 vf [mm/min.]
0,5	2	0,005	150	250	300	450
0,6	2	0,006	180	300	360	540
0,7	2	0,007	210	350	420	630
0,8	2	0,009	270	450	540	810
0,9	2	0,009	270	450	540	810
1,0	2	0,011	330	550	660	990
1,5	2	0,016	480	800	960	1440
2,0	2	0,021	630	1050	1260	1890
2,5	2	0,026	780	1300	1560	2340
3,0	2	0,031	930	1550	1860	2790
3,5	2	0,036	1080	1800	2160	3240
4,0	2	0,040	1200	2000	2400	3600
5,0	2	0,045	1350	2250	2700	4050
6,0	2	0,050	1500	2500	3000	4500
7,0	2	0,055	1650	2750	3300	4950
8,0	2	0,060	1800	3000	3600	5400
9,0	2	0,065	1950	3250	3900	5850
10,0	2	0,070	2100	3500	4200	6300
11,0	2	0,075	2250	3750	4500	6750
12,0	2	0,080	2400	4000	4800	7200

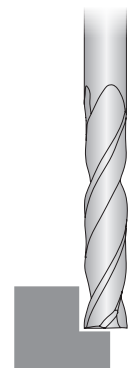

Schlichten
Finishing



Ø d ₁ [mm]	Z	fz [mm]	n 15000 min1 vf [mm/min.]	n 25000 min1 vf [mm/min.]	n 30000 min1 vf [mm/min.]	n 45000 min1 vf [mm/min.]
0,5	2	0,005	150	250	300	450
0,6	2	0,006	180	300	360	540
0,7	2	0,007	210	350	420	630
0,8	2	0,009	270	450	540	810
0,9	2	0,009	270	450	540	810
1,0	2	0,011	330	550	660	990
1,5	2	0,016	480	800	960	1440
2,0	2	0,021	630	1050	1260	1890
2,5	2	0,026	780	1300	1560	2340
3,0	2	0,031	930	1550	1860	2790
3,5	2	0,036	1080	1800	2160	3240
4,0	2	0,040	1200	2000	2400	3600
5,0	2	0,045	1350	2250	2700	4050
6,0	2	0,050	1500	2500	3000	4500
7,0	2	0,055	1650	2750	3300	4950
8,0	2	0,060	1800	3000	3600	5400
9,0	2	0,065	1950	3250	3900	5850
10,0	2	0,070	2100	3500	4200	6300
11,0	2	0,075	2250	3750	4500	6750
12,0	2	0,080	2400	4000	4800	7200

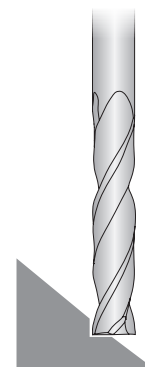

Schlichten
Finishing

Achtung:

Die angegebenen Schnittparameter sind Richt- und Startwerte. Kundenspezifische Gegebenheiten wie Antriebsleistung, Maschinenstabilität, Werkzeugauskragung etc. sind hierbei nicht berücksichtigt.

Attention:

These cutting data are recommendations only. Customer specific circumstances such as machine power, stability, tool overhang etc. are not taken into consideration.

AFD50121-...

DLC-Beschichtung für Aluminiumlegierungen

DLC coating for aluminium alloys

$\varnothing d_1$ [mm]	Z	Vc m/min.	fz [mm]	n [U/min ¹]	vf [mm/min.]
0,5	2	50	0,0015	32000	100
1,0	2	100	0,0015	32000	100
1,5	2	130	0,002	32000	200
2,0	2	170	0,005	27000	300
2,5	2	190	0,007	23000	330
3,0	2	190	0,012	20000	510
3,5	2	190	0,015	17000	510
4,0	2	190	0,017	15000	520
5,0	2	190	0,022	12000	540
6,0	2	190	0,030	10000	600
7,0	2	190	0,035	9000	630
8,0	2	200	0,040	8000	650
9,0	2	200	0,045	7200	650
10,0	2	200	0,050	6400	680
11,0	2	200	0,060	6000	720
12,0	2	200	0,070	5500	800

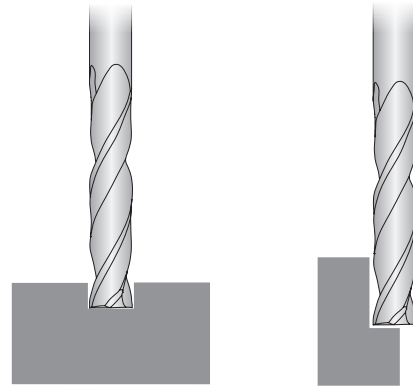

DLC-Beschichtung für Kupferlegierungen

DLC coating for copper alloys

$\varnothing d_1$ [mm]	Z	Vc m/min.	fz [mm]	n [U/min ¹]	vf [mm/min.]
0,5	2	50	0,0015	32000	100
1,0	2	75	0,003	24000	150
1,5	2	75	0,004	18000	150
2,0	2	75	0,006	12000	150
2,5	2	75	0,010	10000	200
3,0	2	75	0,014	8000	230
3,5	2	75	0,017	7000	240
4,0	2	75	0,020	6000	240
5,0	2	75	0,025	4800	240
6,0	2	80	0,030	4000	240
7,0	2	80	0,035	3500	250
8,0	2	80	0,045	3000	270
9,0	2	80	0,055	2750	300
10,0	2	80	0,065	2500	325
11,0	2	80	0,080	2250	360
12,0	2	80	0,090	2000	360

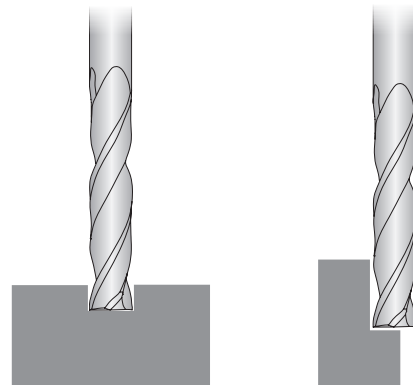

Achtung:
Die angegebenen Schnittparameter sind Richt- und Startwerte.
Kundenspezifische Gegebenheiten wie Antriebsleistung, Maschinenstabilität,
Werkzeugauskragung etc. sind hierbei nicht berücksichtigt.

Attention:
These cutting data are recommendations only.
Customer specific circumstances such as machine power, stability,
tool overhang etc. are not taken into consideration.

AFD51520-...

DLC-Beschichtung für Aluminiumlegierungen

DLC coating for aluminium alloys

$\varnothing d_1$ [mm]	Z	Vc m/min.	fz [mm]	n [U/min ¹]	vf [mm/min.]
1,0	2	95	0,004	30000	260
2,0	2	190	0,007	30000	450
3,0	2	225	0,014	24000	700
4,0	2	190	0,023	20000	950
5,0	2	205	0,040	13000	1100
6,0	2	245	0,046	13000	1200
8,0	2	275	0,068	11000	1500
10,0	2	265	0,100	8500	1800
12,0	2	270	0,150	7200	2200
16,0	2	300	0,160	6000	2000
20,0	2	226	0,220	3600	1600

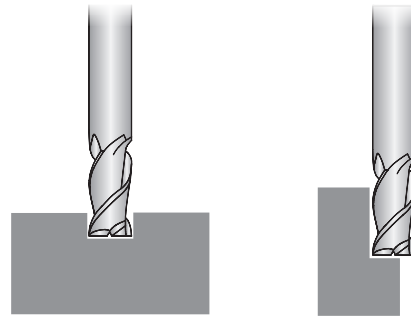

AFD

DLC-Beschichtung für Kupferlegierungen

DLC coating for copper alloys

$\varnothing d_1$ [mm]	Z	Vc m/min.	fz [mm]	n [U/min ¹]	vf [mm/min.]
1,0	2	62	0,002	20000	80
2,0	2	125	0,004	20000	160
3,0	2	130	0,010	14000	280
4,0	2	140	0,017	11000	380
5,0	2	120	0,026	7500	400
6,0	2	140	0,030	7500	480
8,0	2	150	0,050	6000	580
10,0	2	150	0,070	4800	700
12,0	2	150	0,100	3900	850
16,0	2	166	0,120	3300	780
20,0	2	125	0,150	2000	630

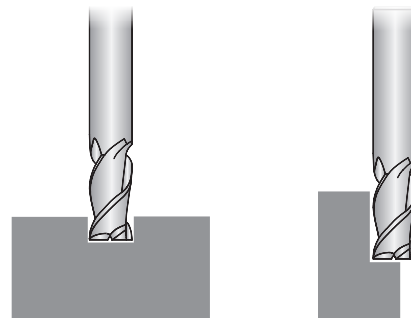
**Achtung:**

Die angegebenen Schnittparameter sind Richt- und Startwerte.
Kundenspezifische Gegebenheiten wie Antriebsleistung, Maschinenstabilität,
Werkzeugauskragung etc. sind hierbei nicht berücksichtigt.

Attention:

These cutting data are recommendations only.
Customer specific circumstances such as machine power, stability,
tool overhang etc. are not taken into consideration.

Alle Angaben in mm / Dimensions in mm

AFD51824-...

D100-Beschichtung für Graphitbearbeitung

D100 coating for graphite machining

AFD

Ø d ₁ [mm]	Z	fz [mm]	n 15000 min1 vf [mm/min.]	n 25000 min1 vf [mm/min.]	n 30000 min1 vf [mm/min.]	n 45000 min1 vf [mm/min.]
0,2	2	0,003	90	150	180	270
0,3	2	0,004	120	200	240	360
0,4	2	0,004	120	200	240	360
0,5	2	0,005	150	250	300	450
0,6	2	0,006	180	300	360	540
0,8	2	0,008	240	400	480	720
1,0	2	0,009	270	450	540	810
1,2	2	0,011	330	550	660	990
1,5	2	0,014	420	700	840	1260
2,0	2	0,019	570	950	1140	1710
3,0	2	0,028	840	1400	1680	2520
4,0	2	0,037	1110	1850	2220	3330
5,0	2	0,046	1380	2300	2760	4140
6,0	2	0,055	1650	2750	3300	4950

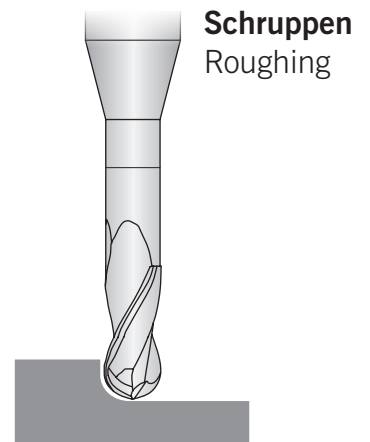

Ø d ₁ [mm]	Z	fz [mm]	n 15000 min1 vf [mm/min.]	n 25000 min1 vf [mm/min.]	n 30000 min1 vf [mm/min.]	n 45000 min1 vf [mm/min.]
0,2	2	0,003	90	150	180	270
0,3	2	0,003	90	150	180	270
0,4	2	0,004	120	200	240	360
0,5	2	0,004	120	200	240	360
0,6	2	0,004	120	200	240	360
0,8	2	0,006	180	300	360	540
1,0	2	0,007	210	350	420	630
1,2	2	0,009	270	450	540	810
1,5	2	0,011	330	550	660	990
2,0	2	0,015	450	750	900	1350
3,0	2	0,022	660	1100	1320	1980
4,0	2	0,029	870	1450	1740	2610
5,0	2	0,036	1080	1800	2160	3240
6,0	2	0,043	1290	2150	2580	3870

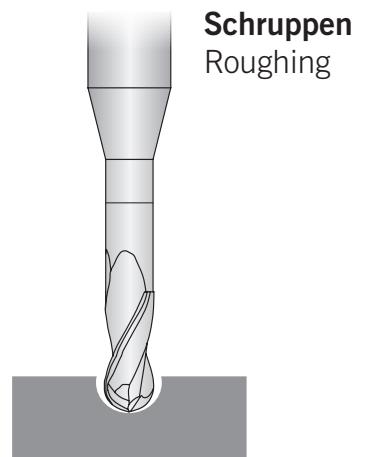

Achtung:
Die angegebenen Schnittparameter sind Richt- und Startwerte.
Kundenspezifische Gegebenheiten wie Antriebsleistung, Maschinenstabilität,
Werkzeugauskragung etc. sind hierbei nicht berücksichtigt.

Attention:
These cutting data are recommendations only.
Customer specific circumstances such as machine power, stability,
tool overhang etc. are not taken into consideration.

AFD51824-...

D100-Beschichtung für Graphitbearbeitung

D100 coating for graphite machining

Ø d ₁ [mm]	Z	fz [mm]	n 15000 min1 vf [mm/min.]	n 25000 min1 vf [mm/min.]	n 30000 min1 vf [mm/min.]	n 45000 min1 vf [mm/min.]
0,2	2	0,003	90	150	180	270
0,3	2	0,004	120	200	240	360
0,4	2	0,004	120	200	240	360
0,5	2	0,005	150	250	300	450
0,6	2	0,006	180	300	360	540
0,8	2	0,009	270	450	540	810
1,0	2	0,011	330	550	660	990
1,2	2	0,013	390	650	780	1170
1,5	2	0,016	480	800	960	1440
2,0	2	0,021	630	1050	1260	1890
3,0	2	0,032	960	1600	1920	2880
4,0	2	0,042	1260	2100	2520	3780
5,0	2	0,053	1590	2650	3180	4770
6,0	2	0,063	1890	3150	3780	5670

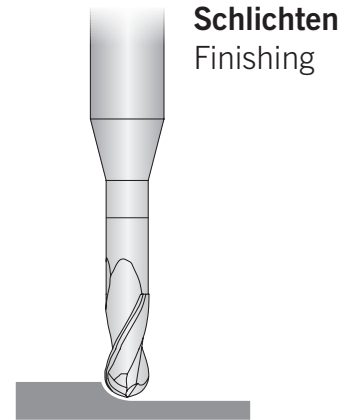

AFD

Ø d ₁ [mm]	Z	fz [mm]	n 15000 min1 vf [mm/min.]	n 25000 min1 vf [mm/min.]	n 30000 min1 vf [mm/min.]	n 45000 min1 vf [mm/min.]
0,2	2	0,003	90	150	180	270
0,3	2	0,004	120	200	240	360
0,4	2	0,004	120	200	240	360
0,5	2	0,005	150	250	300	450
0,6	2	0,006	180	300	360	540
0,8	2	0,009	270	450	540	810
1,0	2	0,011	330	550	660	990
1,2	2	0,013	390	650	780	1170
1,5	2	0,016	480	800	960	1440
2,0	2	0,021	630	1050	1260	1890
3,0	2	0,032	960	1600	1920	2880
4,0	2	0,042	1260	2100	2520	3780
5,0	2	0,053	1590	2650	3180	4770
6,0	2	0,063	1890	3150	3780	5670

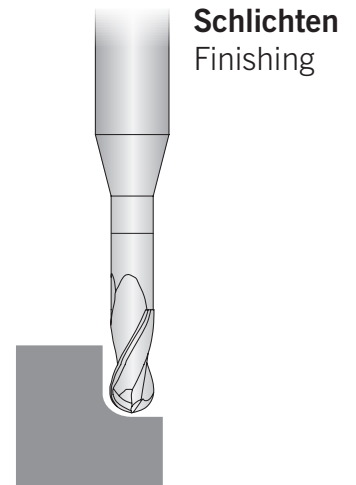

Achtung:
Die angegebenen Schnittparameter sind Richt- und Startwerte.
Kundenspezifische Gegebenheiten wie Antriebsleistung, Maschinenstabilität, Werkzeugauskrantung etc. sind hierbei nicht berücksichtigt.

Attention:
These cutting data are recommendations only.
Customer specific circumstances such as machine power, stability, tool overhang etc. are not taken into consideration.

Alle Angaben in mm / Dimensions in mm

AFD51824-...

DLC-Beschichtung für Aluminiumlegierungen

DLC coating for aluminium alloys

Ø d ₁ [mm]	Z	Vc m/min.	fz [mm]	n [U/min ¹]	vf [mm/min.]
0,5	2	78	0,008	50000	850
0,6	2	94	0,013	50000	1300
0,8	2	125	0,016	50000	1600
1,0	2	144	0,021	46000	2000
1,2	2	146	0,025	39000	2000
1,5	2	170	0,027	36000	2000
2,0	2	170	0,030	27000	1800
3,0	2	190	0,045	20000	1800
4,0	2	190	0,060	15000	1800
5,0	2	190	0,075	12000	1800
6,0	2	190	0,090	10000	1800

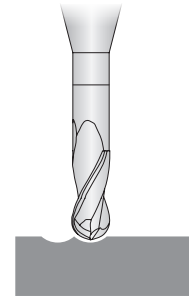

DLC-Beschichtung für Kupferlegierungen

DLC coating for copper alloys

Ø d ₁ [mm]	Z	Vc m/min.	fz [mm]	n [U/min ¹]	vf [mm/min.]
0,5	2	67	0,007	43000	650
0,6	2	80	0,011	43000	1000
0,8	2	95	0,015	38000	1200
1,0	2	105	0,020	34000	1400
1,2	2	110	0,024	29000	1400
1,5	2	125	0,026	26000	1400
2,0	2	125	0,032	20000	1300
3,0	2	125	0,048	13500	1300
4,0	2	125	0,065	10000	1300
5,0	2	125	0,080	8000	1300
6,0	2	125	0,090	6800	1300

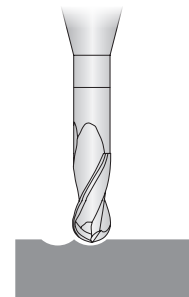

Achtung:
Die angegebenen Schnittparameter sind Richt- und Startwerte.
Kundenspezifische Gegebenheiten wie Antriebsleistung, Maschinenstabilität,
Werkzeugauskragung etc. sind hierbei nicht berücksichtigt.

Attention:
These cutting data are recommendations only.
Customer specific circumstances such as machine power, stability,
tool overhang etc. are not taken into consideration.

AFD50325-...

D100-Beschichtung für Graphitbearbeitung

D100 coating for graphite machining

Ø d ₁ [mm]	Z	fz [mm]	n 15000 min1 vf [mm/min.]	n 25000 min1 vf [mm/min.]	n 30000 min1 vf [mm/min.]	n 45000 min1 vf [mm/min.]
0,4	2	0,005	150	250	300	450
0,6	2	0,006	180	300	360	540
1,0	2	0,009	270	450	540	810
1,5	2	0,014	420	700	840	1260
2,0	2	0,019	570	950	1140	1710
4,0	2	0,038	1140	1900	2280	3420

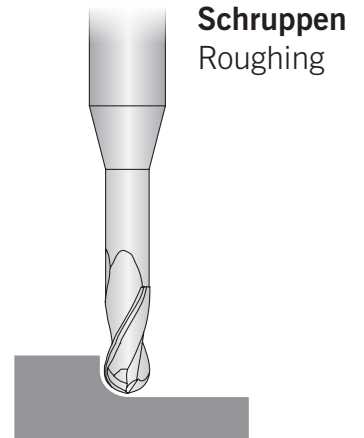

AFD

Ø d ₁ [mm]	Z	fz [mm]	n 15000 min1 vf [mm/min.]	n 25000 min1 vf [mm/min.]	n 30000 min1 vf [mm/min.]	n 45000 min1 vf [mm/min.]
0,4	2	0,004	120	200	240	360
0,6	2	0,004	120	200	240	360
1,0	2	0,007	210	350	420	630
1,5	2	0,011	330	550	660	990
2,0	2	0,015	450	750	900	1350
4,0	2	0,029	870	1450	1750	2610

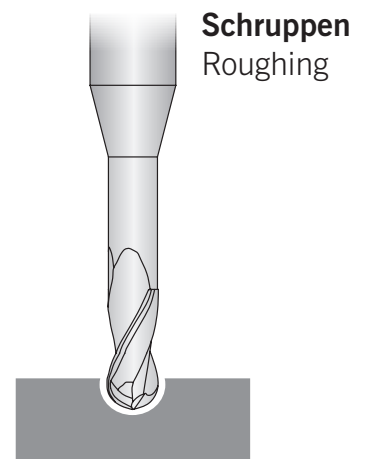

Achtung:
Die angegebenen Schnittparameter sind Richt- und Startwerte.
Kundenspezifische Gegebenheiten wie Antriebsleistung, Maschinenstabilität,
Werkzeugauskragung etc. sind hierbei nicht berücksichtigt.

Attention:
These cutting data are recommendations only.
Customer specific circumstances such as machine power, stability,
tool overhang etc. are not taken into consideration.

Alle Angaben in mm / Dimensions in mm

AFD50325-...

D100-Beschichtung für Graphitbearbeitung

D100 coating for graphite machining

AFD

Ø d ₁ [mm]	Z	fz [mm]	n 15000 min1 vf [mm/min.]	n 25000 min1 vf [mm/min.]	n 30000 min1 vf [mm/min.]	n 45000 min1 vf [mm/min.]
0,4	2	0,005	150	250	300	450
0,6	2	0,006	180	300	360	540
1,0	2	0,011	330	550	660	990
1,5	2	0,016	480	800	960	1440
2,0	2	0,021	630	1050	1260	1890
4,0	2	0,044	1320	2200	2640	3960

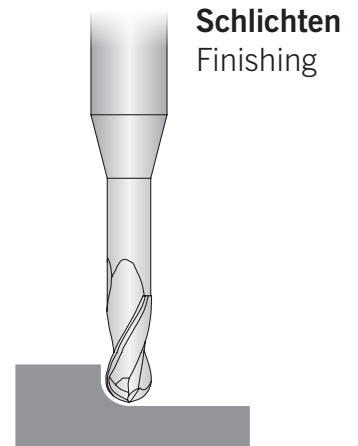

Ø d ₁ [mm]	Z	fz [mm]	n 15000 min1 vf [mm/min.]	n 25000 min1 vf [mm/min.]	n 30000 min1 vf [mm/min.]	n 45000 min1 vf [mm/min.]
0,4	2	0,005	150	250	300	450
0,6	2	0,006	180	300	360	540
1,0	2	0,011	330	550	660	990
1,5	2	0,016	480	800	960	1440
2,0	2	0,021	630	1050	1260	1890
4,0	2	0,044	1320	2200	2640	3960

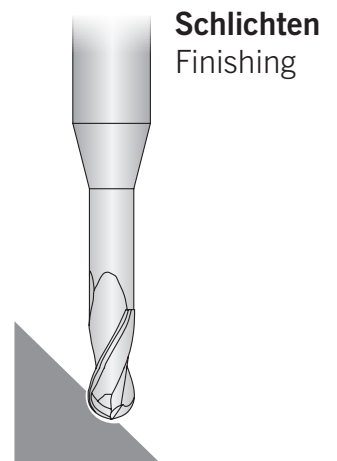

Achtung:
Die angegebenen Schnittparameter sind Richt- und Startwerte.
Kundenspezifische Gegebenheiten wie Antriebsleistung, Maschinenstabilität,
Werkzeugauskragung etc. sind hierbei nicht berücksichtigt.

Attention:
These cutting data are recommendations only.
Customer specific circumstances such as machine power, stability,
tool overhang etc. are not taken into consideration.

Alle Angaben in mm / Dimensions in mm

AFD51826-...

D100-Beschichtung für Graphitbearbeitung

D100 coating for graphite machining

Ø d ₁ [mm]	Z	fz [mm]	n 15000 min1 vf [mm/min.]	n 25000 min1 vf [mm/min.]	n 30000 min1 vf [mm/min.]	n 45000 min1 vf [mm/min.]
1,0	2	0,007	210	350	420	630
1,5	2	0,011	330	550	660	990
2,0	2	0,014	420	700	840	1260

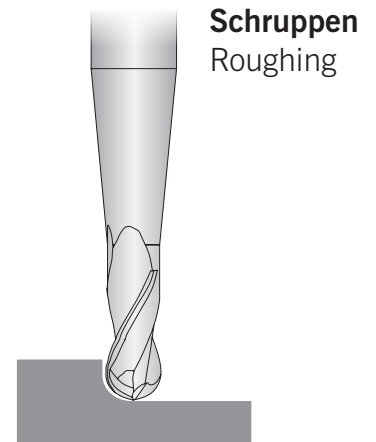

AFD

Ø d ₁ [mm]	Z	fz [mm]	n 15000 min1 vf [mm/min.]	n 25000 min1 vf [mm/min.]	n 30000 min1 vf [mm/min.]	n 45000 min1 vf [mm/min.]
1,0	2	0,008	240	400	480	720
1,5	2	0,012	360	600	720	1080
2,0	2	0,016	480	800	960	1440

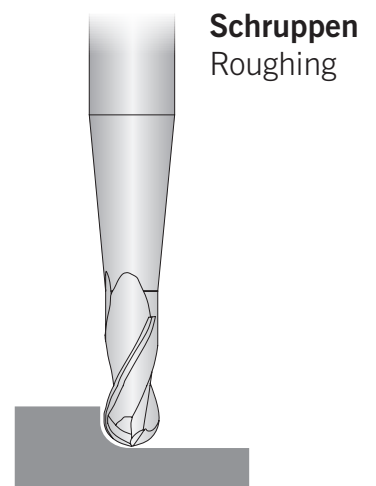

Achtung:
Die angegebenen Schnittparameter sind Richt- und Startwerte.
Kundenspezifische Gegebenheiten wie Antriebsleistung, Maschinenstabilität,
Werkzeugauskragung etc. sind hierbei nicht berücksichtigt.

Attention:
These cutting data are recommendations only.
Customer specific circumstances such as machine power, stability,
tool overhang etc. are not taken into consideration.

Alle Angaben in mm / Dimensions in mm

AFD51826-...

D100-Beschichtung für Graphitbearbeitung

D100 coating for graphite machining

Ø d ₁ [mm]	Z	fz [mm]	n 15000 min1 vf [mm/min.]	n 25000 min1 vf [mm/min.]	n 30000 min1 vf [mm/min.]	n 45000 min1 vf [mm/min.]
1,0	2	0,008	240	400	480	720
1,5	2	0,012	360	600	720	1080
2,0	2	0,016	480	800	960	1440

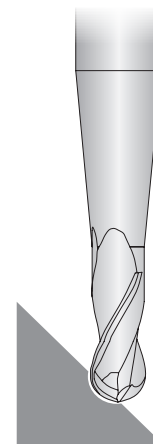

Schlichten
Finishing

AFD

Achtung:
Die angegebenen Schnittparameter sind Richt- und Startwerte.
Kundenspezifische Gegebenheiten wie Antriebsleistung, Maschinenstabilität,
Werkzeugauskragung etc. sind hierbei nicht berücksichtigt.

Attention:
These cutting data are recommendations only.
Customer specific circumstances such as machine power, stability,
tool overhang etc. are not taken into consideration.

AFD51826-...

DLC-Beschichtung für Aluminiumlegierungen

DLC coating for aluminium alloys

$\varnothing d_1$ [mm]	Z	Vc m/min.	fz [mm]	n [U/min ¹]	vf [mm/min.]
1,0	2	144	0,020	46000	1840
1,5	2	170	0,025	36000	1800
2,0	2	170	0,030	27000	1650

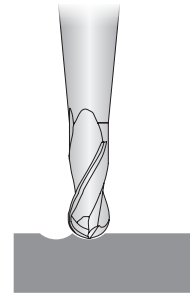

AFD

DLC-Beschichtung für Kupferlegierungen

DLC coating for copper alloys

$\varnothing d_1$ [mm]	Z	Vc m/min.	fz [mm]	n [U/min ¹]	vf [mm/min.]
1,0	2	105	0,020	34000	1360
1,5	2	125	0,025	26000	1300
2,0	2	125	0,300	20000	1200

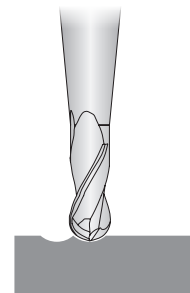
**Achtung:**

Die angegebenen Schnittparameter sind Richt- und Startwerte.
Kundenspezifische Gegebenheiten wie Antriebsleistung, Maschinenstabilität,
Werkzeugauskragung etc. sind hierbei nicht berücksichtigt.

Attention:

These cutting data are recommendations only.
Customer specific circumstances such as machine power, stability,
tool overhang etc. are not taken into consideration.

Alle Angaben in mm / Dimensions in mm

AFD51821-...

D100-Beschichtung für Graphitbearbeitung

D100 coating for graphite machining

AFD

Ø d ₁ [mm]	Z	fz [mm]	n 10000 min1 vf [mm/min.]	n 15000 min1 vf [mm/min.]	n 20000 min1 vf [mm/min.]	n 30000 min1 vf [mm/min.]
2,0	2	0,019	380	570	760	1140
3,0	2	0,028	560	840	1120	1680
4,0	2	0,038	760	1140	1520	2280
5,0	2	0,047	940	1410	1880	2820
6,0	2	0,056	1120	1680	2240	3360
7,0	2	0,065	1300	1950	2600	3900
8,0	2	0,075	1500	2250	3000	4500
9,0	2	0,084	1680	2520	3360	5040
10,0	2	0,094	1880	2820	3760	5640
12,0	2	0,113	2260	3390	4520	6780

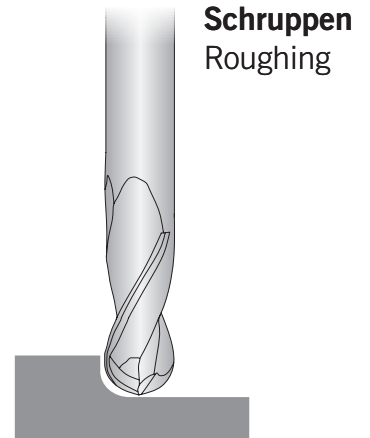

Ø d ₁ [mm]	Z	fz [mm]	n 10000 min1 vf [mm/min.]	n 15000 min1 vf [mm/min.]	n 20000 min1 vf [mm/min.]	n 30000 min1 vf [mm/min.]
2,0	2	0,015	300	450	600	900
3,0	2	0,022	440	660	880	1320
4,0	2	0,029	580	870	1160	1740
5,0	2	0,036	720	1080	1440	2160
6,0	2	0,044	880	1320	1760	2640
7,0	2	0,051	1020	1530	2040	3060
8,0	2	0,058	1160	1740	2320	3480
9,0	2	0,080	1300	1950	2600	3900
10,0	2	0,073	1460	2190	2920	4380
12,0	2	0,087	1740	2610	3480	5220

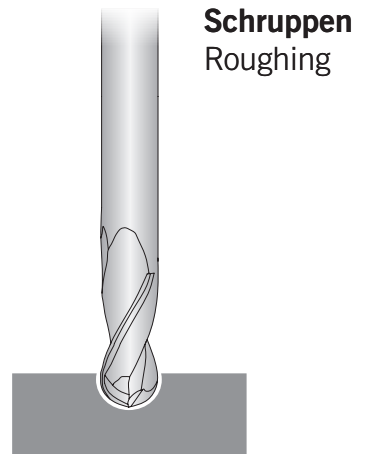

Achtung:
Die angegebenen Schnittparameter sind Richt- und Startwerte.
Kundenspezifische Gegebenheiten wie Antriebsleistung, Maschinenstabilität,
Werkzeugauskragung etc. sind hierbei nicht berücksichtigt.

Attention:
These cutting data are recommendations only.
Customer specific circumstances such as machine power, stability,
tool overhang etc. are not taken into consideration.

AFD51821-...

D100-Beschichtung für Graphitbearbeitung

D100 coating for graphite machining

Ø d ₁ [mm]	Z	fz [mm]	n 10000 min1 vf [mm/min.]	n 15000 min1 vf [mm/min.]	n 20000 min1 vf [mm/min.]	n 30000 min1 vf [mm/min.]
2,0	2	0,021	420	630	840	1260
3,0	2	0,032	640	960	1280	1920
4,0	2	0,043	860	1290	1720	2580
5,0	2	0,053	1060	1590	2120	3180
6,0	2	0,064	1280	1920	2560	3840
7,0	2	0,074	1480	2220	2960	4440
8,0	2	0,085	1700	2550	3400	5100
9,0	2	0,095	1900	2850	3800	5700
10,0	2	0,107	2140	3210	4280	6420
12,0	2	0,128	2560	3840	5120	7680

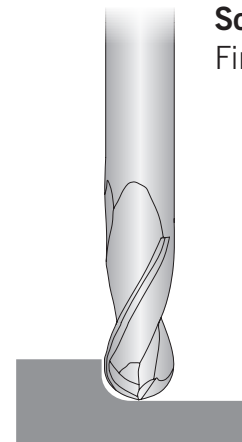

Schlichten
Finishing

AFD

Ø d ₁ [mm]	Z	fz [mm]	n 10000 min1 vf [mm/min.]	n 15000 min1 vf [mm/min.]	n 20000 min1 vf [mm/min.]	n 30000 min1 vf [mm/min.]
2,0	2	0,021	420	630	840	1260
3,0	2	0,032	640	960	1280	1920
4,0	2	0,043	860	1290	1720	2580
5,0	2	0,053	1060	1590	2120	3180
6,0	2	0,064	1280	1920	2560	3840
7,0	2	0,074	1480	2220	2960	4440
8,0	2	0,085	1700	2550	3400	5100
9,0	2	0,095	1900	2850	3800	5700
10,0	2	0,107	2140	3210	4280	6420
12,0	2	0,128	2560	3840	5120	7680

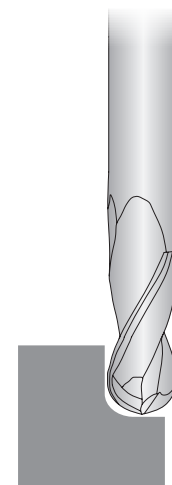

Schlichten
Finishing

Achtung:
Die angegebenen Schnittparameter sind Richt- und Startwerte.
Kundenspezifische Gegebenheiten wie Antriebsleistung, Maschinenstabilität,
Werkzeugauskragung etc. sind hierbei nicht berücksichtigt.

Attention:
These cutting data are recommendations only.
Customer specific circumstances such as machine power, stability,
tool overhang etc. are not taken into consideration.

Alle Angaben in mm / Dimensions in mm

AFD51821-...

DLC-Beschichtung für Aluminiumlegierungen

DLC coating for aluminium alloys

$\varnothing d_1$ [mm]	Z	Vc m/min.	fz [mm]	n [U/min ¹]	vf [mm/min.]
2,0	2	160	0,020	25000	1000
3,0	2	160	0,029	17000	1000
4,0	2	160	0,040	12500	1000
5,0	2	160	0,060	10000	1200
6,0	2	160	0,080	8500	1350
8,0	2	175	0,100	7000	1450
10,0	2	188	0,120	6000	1450
12,0	2	188	0,140	5000	1450

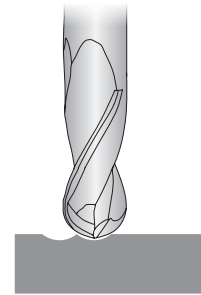

DLC-Beschichtung für Kupferlegierungen

DLC coating for copper alloys

$\varnothing d_1$ [mm]	Z	Vc m/min.	fz [mm]	n [U/min ¹]	vf [mm/min.]
2,0	2	120	0,020	19000	800
3,0	2	115	0,032	12500	800
4,0	2	120	0,042	9500	800
5,0	2	120	0,055	7600	850
6,0	2	120	0,070	6400	900
8,0	2	130	0,090	5100	900
10,0	2	130	0,110	4200	900
12,0	2	130	0,130	3500	900

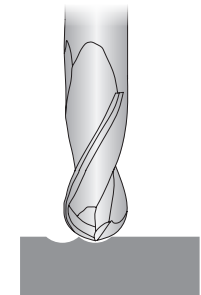

Achtung:
Die angegebenen Schnittparameter sind Richt- und Startwerte.
Kundenspezifische Gegebenheiten wie Antriebsleistung, Maschinenstabilität,
Werkzeugauskragung etc. sind hierbei nicht berücksichtigt.

Attention:
These cutting data are recommendations only.
Customer specific circumstances such as machine power, stability,
tool overhang etc. are not taken into consideration.

Alle Angaben in mm / Dimensions in mm

AFD51823-...

D100-Beschichtung für Graphitbearbeitung

D100 coating for graphite machining

Ø d ₁ [mm]	Z	fz [mm]	n 10000 min1 vf [mm/min.]	n 15000 min1 vf [mm/min.]	n 20000 min1 vf [mm/min.]	n 30000 min1 vf [mm/min.]
2,0	2	0,019	380	570	760	1140
3,0	2	0,028	560	840	1120	1680
4,0	2	0,038	760	1140	1520	2280
5,0	2	0,047	940	1410	1880	2820
6,0	2	0,056	1120	1680	2240	3360
7,0	2	0,065	1300	1950	2600	3900
8,0	2	0,075	1500	2250	3000	4500
9,0	2	0,084	1680	2520	3360	5040
10,0	2	0,094	1880	2820	3760	5640
12,0	2	0,113	2260	3390	4520	6780

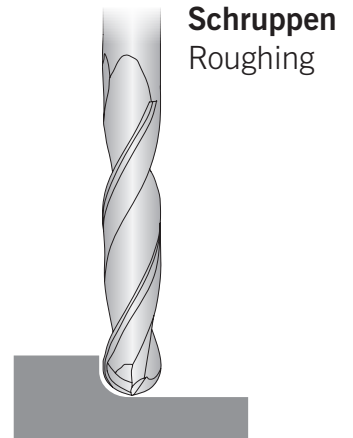

AFD

Ø d ₁ [mm]	Z	fz [mm]	n 10000 min1 vf [mm/min.]	n 15000 min1 vf [mm/min.]	n 20000 min1 vf [mm/min.]	n 30000 min1 vf [mm/min.]
2,0	2	0,015	300	450	600	900
3,0	2	0,022	440	660	880	1320
4,0	2	0,029	580	870	1160	1740
5,0	2	0,036	720	1080	1440	2160
6,0	2	0,044	880	1320	1760	2640
7,0	2	0,051	1020	1530	2040	3060
8,0	2	0,058	1160	1740	2320	3480
9,0	2	0,080	1300	1950	2600	3900
10,0	2	0,073	1460	2190	2920	4380
12,0	2	0,087	1740	2610	3480	5220

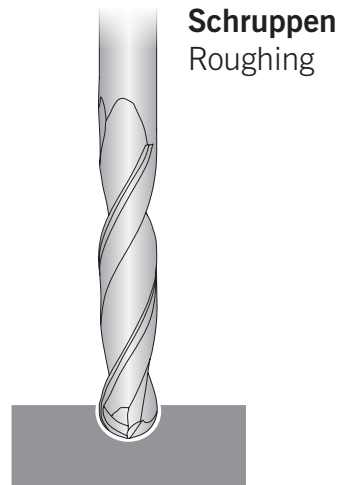

Achtung:
Die angegebenen Schnittparameter sind Richt- und Startwerte.
Kundenspezifische Gegebenheiten wie Antriebsleistung, Maschinenstabilität,
Werkzeugauskragung etc. sind hierbei nicht berücksichtigt.

Attention:
These cutting data are recommendations only.
Customer specific circumstances such as machine power, stability,
tool overhang etc. are not taken into consideration.

Alle Angaben in mm / Dimensions in mm

AFD51823-...

D100-Beschichtung für Graphitbearbeitung

D100 coating for graphite machining

AFD

Ø d ₁ [mm]	Z	fz [mm]	n 10000 min1 vf [mm/min.]	n 15000 min1 vf [mm/min.]	n 20000 min1 vf [mm/min.]	n 30000 min1 vf [mm/min.]
2,0	2	0,021	420	630	840	1260
3,0	2	0,032	640	960	1280	1920
4,0	2	0,043	860	1290	1720	2580
5,0	2	0,053	1060	1590	2120	3180
6,0	2	0,064	1280	1920	2560	3840
7,0	2	0,074	1480	2220	2960	4440
8,0	2	0,085	1700	2550	3400	5100
9,0	2	0,095	1900	2850	3800	5700
10,0	2	0,107	2140	3210	4280	6420
12,0	2	0,128	2560	3840	5120	7680

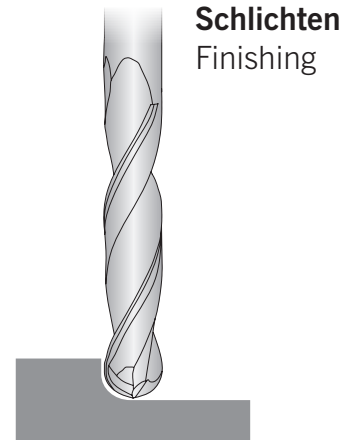

Ø d ₁ [mm]	Z	fz [mm]	n 10000 min1 vf [mm/min.]	n 15000 min1 vf [mm/min.]	n 20000 min1 vf [mm/min.]	n 30000 min1 vf [mm/min.]
2,0	2	0,021	420	630	840	1260
3,0	2	0,032	640	960	1280	1920
4,0	2	0,043	860	1290	1720	2580
5,0	2	0,053	1060	1590	2120	3180
6,0	2	0,064	1280	1920	2560	3840
7,0	2	0,074	1480	2220	2960	4440
8,0	2	0,085	1700	2550	3400	5100
9,0	2	0,095	1900	2850	3800	5700
10,0	2	0,107	2140	3210	4280	6420
12,0	2	0,128	2560	3840	5120	7680

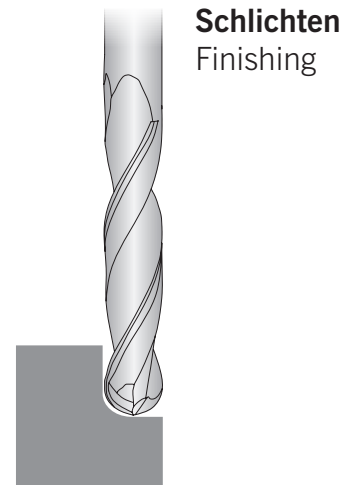

Achtung:
Die angegebenen Schnittparameter sind Richt- und Startwerte.
Kundenspezifische Gegebenheiten wie Antriebsleistung, Maschinenstabilität,
Werkzeugauskragung etc. sind hierbei nicht berücksichtigt.

Attention:
These cutting data are recommendations only.
Customer specific circumstances such as machine power, stability,
tool overhang etc. are not taken into consideration.

AFD51823-...

DLC-Beschichtung für Aluminiumlegierungen

DLC coating for aluminium alloys

$\varnothing d_1$ [mm]	Z	Vc m/min.	fz [mm]	n [U/min ¹]	vf [mm/min.]
2,0	2	160	0,020	25000	1000
3,0	2	160	0,029	17000	1000
4,0	2	160	0,040	12500	1000
5,0	2	160	0,060	10000	1200
6,0	2	160	0,080	8500	1350
7,0	2	175	0,090	8000	1450
8,0	2	175	0,100	7000	1450
9,0	2	180	0,110	6400	1400
10,0	2	188	0,120	6000	1450
12,0	2	188	0,140	5000	1450

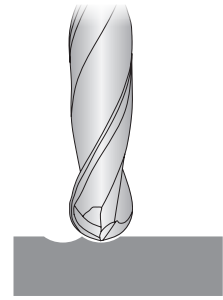

AFD

DLC-Beschichtung für Kupferlegierungen

DLC coating for copper alloys

$\varnothing d_1$ [mm]	Z	Vc m/min.	fz [mm]	n [U/min ¹]	vf [mm/min.]
2,0	2	120	0,020	19000	800
3,0	2	115	0,032	12500	800
4,0	2	120	0,042	9500	800
5,0	2	120	0,055	7600	850
6,0	2	120	0,070	6400	900
7,0	2	125	0,080	5700	900
8,0	2	130	0,090	5100	900
9,0	2	130	0,100	4600	900
10,0	2	130	0,110	4200	900
12,0	2	130	0,130	3500	900

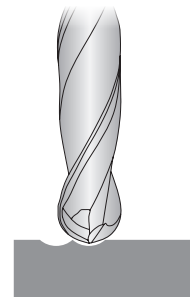
**Achtung:**

Die angegebenen Schnittparameter sind Richt- und Startwerte.
Kundenspezifische Gegebenheiten wie Antriebsleistung, Maschinenstabilität,
Werkzeugauskragung etc. sind hierbei nicht berücksichtigt.

Attention:

These cutting data are recommendations only.
Customer specific circumstances such as machine power, stability,
tool overhang etc. are not taken into consideration.

Alle Angaben in mm / Dimensions in mm

AFD51820-...

D100-Beschichtung für Graphitbearbeitung

D100 coating for graphite machining

AFD

Ø d ₁ [mm]	Z	fz [mm]	n 10000 min1 vf [mm/min.]	n 15000 min1 vf [mm/min.]	n 20000 min1 vf [mm/min.]	n 30000 min1 vf [mm/min.]
2,0	2	0,018	360	540	720	1080
2,5	2	0,023	460	690	920	1380
3,0	2	0,028	560	840	1120	1680
3,5	2	0,033	660	990	1320	1980
4,0	2	0,038	760	1140	1520	2280
5,0	2	0,047	940	1410	1880	2820
6,0	2	0,056	1120	1680	2240	3360
8,0	2	0,075	1500	2250	3000	4500
10,0	2	0,094	1880	2820	3760	5640
12,0	2	0,113	2260	3390	4520	6780

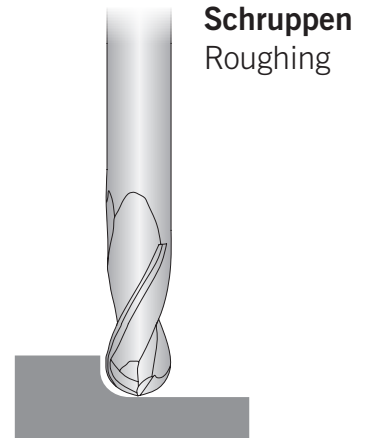

Ø d ₁ [mm]	Z	fz [mm]	n 10000 min1 vf [mm/min.]	n 15000 min1 vf [mm/min.]	n 20000 min1 vf [mm/min.]	n 30000 min1 vf [mm/min.]
2,0	2	0,015	300	450	600	900
2,5	2	0,018	360	540	720	1080
3,0	2	0,022	440	660	880	1320
3,5	2	0,026	520	780	1040	1560
4,0	2	0,029	580	870	1160	1740
5,0	2	0,036	720	1080	1440	2160
6,0	2	0,044	880	1320	1760	2640
8,0	2	0,058	1160	1740	2320	3480
10,0	2	0,073	1460	2190	2920	4380
12,0	2	0,087	1740	2610	3480	5220

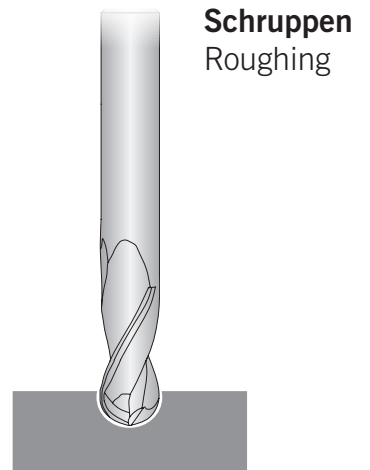

Achtung:
Die angegebenen Schnittparameter sind Richt- und Startwerte.
Kundenspezifische Gegebenheiten wie Antriebsleistung, Maschinenstabilität,
Werkzeugauskragung etc. sind hierbei nicht berücksichtigt.

Attention:
These cutting data are recommendations only.
Customer specific circumstances such as machine power, stability,
tool overhang etc. are not taken into consideration.

AFD51820-...

D100-Beschichtung für Graphitbearbeitung

D100 coating for graphite machining

Ø d ₁ [mm]	Z	fz [mm]	n 10000 min1 vf [mm/min.]	n 15000 min1 vf [mm/min.]	n 20000 min1 vf [mm/min.]	n 30000 min1 vf [mm/min.]
2,0	2	0,022	440	660	880	1320
2,5	2	0,027	540	810	1080	1620
3,0	2	0,032	640	960	1280	1920
3,5	2	0,037	740	1110	1480	2220
4,0	2	0,043	860	1290	1720	2580
5,0	2	0,053	1060	1590	2120	3180
6,0	2	0,064	1280	1920	2560	3840
8,0	2	0,085	1700	2550	3400	5100
10,0	2	0,107	2140	3210	4280	6420
12,0	2	0,128	2560	3840	5120	7680

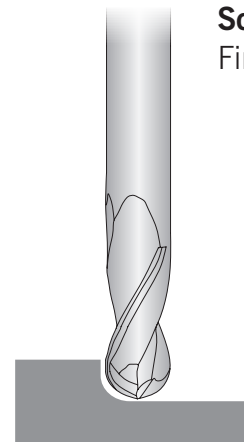

Schlichten
Finishing

AFD

Ø d ₁ [mm]	Z	fz [mm]	n 10000 min1 vf [mm/min.]	n 15000 min1 vf [mm/min.]	n 20000 min1 vf [mm/min.]	n 30000 min1 vf [mm/min.]
2,0	2	0,022	440	660	880	1320
2,5	2	0,027	540	810	1080	1620
3,0	2	0,032	640	960	1280	1920
3,5	2	0,037	740	1110	1480	2220
4,0	2	0,043	860	1290	1720	2580
5,0	2	0,053	1060	1590	2120	3180
6,0	2	0,064	1280	1920	2560	3840
8,0	2	0,085	1700	2550	3400	5100
10,0	2	0,107	2140	3210	4280	6420
12,0	2	0,128	2560	3840	5120	7680

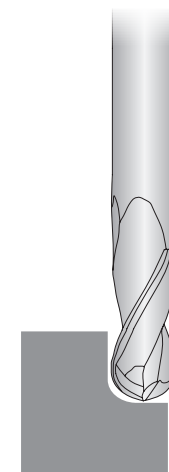

Schlichten
Finishing

Achtung:
Die angegebenen Schnittparameter sind Richt- und Startwerte.
Kundenspezifische Gegebenheiten wie Antriebsleistung, Maschinenstabilität,
Werkzeugauskragung etc. sind hierbei nicht berücksichtigt.

Attention:
These cutting data are recommendations only.
Customer specific circumstances such as machine power, stability,
tool overhang etc. are not taken into consideration.

Alle Angaben in mm / Dimensions in mm

AFD51820-...

DLC-Beschichtung für Aluminiumlegierungen

DLC coating for aluminium alloys

$\varnothing d_1$ [mm]	Z	Vc m/min.	fz [mm]	n [U/min ¹]	vf [mm/min.]
2,0	2	160	0,020	25000	1000
3,0	2	160	0,029	17000	1000
4,0	2	160	0,040	12500	1000
5,0	2	160	0,060	10000	1200
6,0	2	160	0,080	8500	1350
8,0	2	175	0,100	7000	1450
10,0	2	188	0,120	6000	1450
12,0	2	188	0,140	5000	1450

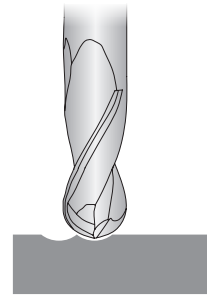

DLC-Beschichtung für Kupferlegierungen

DLC coating for copper alloys

$\varnothing d_1$ [mm]	Z	Vc m/min.	fz [mm]	n [U/min ¹]	vf [mm/min.]
2,0	2	120	0,020	19000	800
3,0	2	115	0,032	12500	800
4,0	2	120	0,042	9500	800
5,0	2	120	0,055	7600	850
6,0	2	120	0,070	6400	900
8,0	2	130	0,090	5100	900
10,0	2	130	0,110	4200	900
12,0	2	130	0,130	3500	900

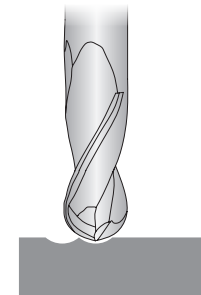

Achtung:
Die angegebenen Schnittparameter sind Richt- und Startwerte.
Kundenspezifische Gegebenheiten wie Antriebsleistung, Maschinenstabilität,
Werkzeugauskragung etc. sind hierbei nicht berücksichtigt.

Attention:
These cutting data are recommendations only.
Customer specific circumstances such as machine power, stability,
tool overhang etc. are not taken into consideration.

Alle Angaben in mm / Dimensions in mm

AFD54030-...

D100-Beschichtung für Graphitbearbeitung

D100 coating for graphite machining

Ø d ₁ [mm]	Z	fz [mm]	n 10000 min1 vf [mm/min.]	n 15000 min1 vf [mm/min.]	n 20000 min1 vf [mm/min.]	n 30000 min1 vf [mm/min.]
2,0	3	0,024	720	1080	1440	2160
3,0	3	0,035	1050	1575	2100	3150
4,0	3	0,047	1410	2115	2820	4230
5,0	3	0,059	1770	2655	3540	5310
6,0	3	0,071	2130	3195	4260	6390
8,0	3	0,094	2820	4230	5640	8460
10,0	3	0,118	3540	5310	7080	10620
12,0	3	0,141	4230	6345	8460	12690

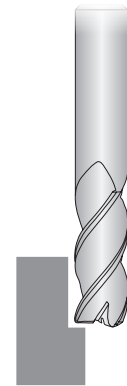

Schruppen
Roughing

AFD

Ø d ₁ [mm]	Z	fz [mm]	n 10000 min1 vf [mm/min.]	n 15000 min1 vf [mm/min.]	n 20000 min1 vf [mm/min.]	n 30000 min1 vf [mm/min.]
2,0	3	0,018	540	810	1080	1620
3,0	3	0,027	810	1215	1620	2430
4,0	3	0,036	1080	1620	2160	3240
5,0	3	0,045	1350	2025	2700	4050
6,0	3	0,055	1650	2475	3300	4950
8,0	3	0,073	2190	3285	4380	6570
10,0	3	0,091	2730	4095	5460	8190
12,0	3	0,109	3270	4905	6540	9810

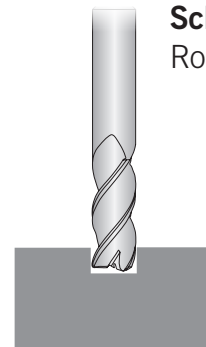

Schruppen
Roughing

Achtung:

Die angegebenen Schnittparameter sind Richt- und Startwerte. Kundenspezifische Gegebenheiten wie Antriebsleistung, Maschinenstabilität, Werkzeugauskragung etc. sind hierbei nicht berücksichtigt.

Attention:

These cutting data are recommendations only. Customer specific circumstances such as machine power, stability, tool overhang etc. are not taken into consideration.

Alle Angaben in mm / Dimensions in mm

AFD54030-...

D100-Beschichtung für Graphitbearbeitung

D100 coating for graphite machining

AFD

Ø d ₁ [mm]	Z	fz [mm]	n 10000 min1 vf [mm/min.]	n 15000 min1 vf [mm/min.]	n 20000 min1 vf [mm/min.]	n 30000 min1 vf [mm/min.]
2,0	3	0,027	810	1215	1620	2430
3,0	3	0,040	1200	1800	2400	3600
4,0	3	0,053	1590	2385	3180	4770
5,0	3	0,067	2010	3015	4020	6030
6,0	3	0,080	2400	3600	4800	7200
8,0	3	0,107	3210	4815	6420	9630
10,0	3	0,133	3990	5985	7980	11970
12,0	3	0,160	4800	7200	9600	14400

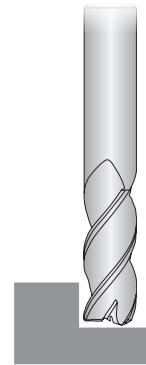

Schlichten
Finishing

Ø d ₁ [mm]	Z	fz [mm]	n 10000 min1 vf [mm/min.]	n 15000 min1 vf [mm/min.]	n 20000 min1 vf [mm/min.]	n 30000 min1 vf [mm/min.]
2,0	3	0,027	810	1215	1620	2430
3,0	3	0,040	1200	1800	2400	3600
4,0	3	0,053	1590	2385	3180	4770
5,0	3	0,067	2010	3015	4020	6030
6,0	3	0,080	2400	3600	4800	7200
8,0	3	0,107	3210	4815	6420	9630
10,0	3	0,133	3990	5985	7980	11970
12,0	3	0,160	4800	7200	9600	14400



Schlichten
Finishing

Achtung:
Die angegebenen Schnittparameter sind Richt- und Startwerte.
Kundenspezifische Gegebenheiten wie Antriebsleistung, Maschinenstabilität,
Werkzeugauskragung etc. sind hierbei nicht berücksichtigt.

Attention:
These cutting data are recommendations only.
Customer specific circumstances such as machine power, stability,
tool overhang etc. are not taken into consideration.

AFD54030-...

DLC-Beschichtung für Aluminiumlegierungen

DLC coating for aluminium alloys

$\varnothing d_1$ [mm]	Z	Vc m/min.	fz [mm]	n [U/min ¹]	vf [mm/min.]
2,0	3	170	0,012	27000	1000
3,0	3	200	0,017	21000	1100
4,0	3	190	0,026	15000	1200
5,0	3	190	0,034	12000	1250
6,0	3	190	0,046	10000	1400
8,0	3	190	0,066	7500	1500
10,0	3	190	0,094	6000	1700
12,0	3	190	0,110	5000	1700

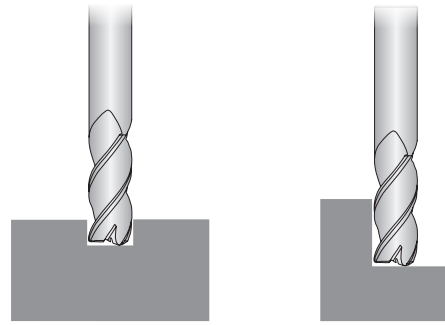

AFD

DLC-Beschichtung für Kupferlegierungen

DLC coating for copper alloys

$\varnothing d_1$ [mm]	Z	Vc m/min.	fz [mm]	n [U/min ¹]	vf [mm/min.]
2,0	3	65	0,008	10000	240
3,0	3	75	0,013	8000	320
4,0	3	75	0,020	6000	360
5,0	3	75	0,026	4800	385
6,0	3	75	0,033	4000	400
8,0	3	75	0,050	3000	460
10,0	3	75	0,066	2400	480
12,0	3	75	0,080	2000	510

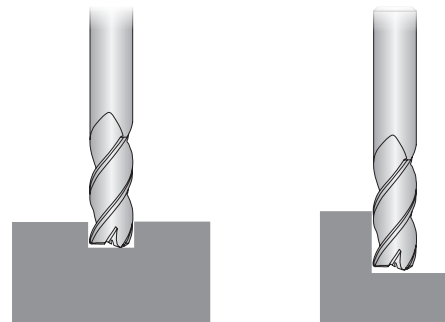
**Achtung:**

Die angegebenen Schnittparameter sind Richt- und Startwerte.
Kundenspezifische Gegebenheiten wie Antriebsleistung, Maschinenstabilität,
Werkzeugauskragung etc. sind hierbei nicht berücksichtigt.

Attention:

These cutting data are recommendations only.
Customer specific circumstances such as machine power, stability,
tool overhang etc. are not taken into consideration.

Alle Angaben in mm / Dimensions in mm

AFD54031-...

D100-Beschichtung für Graphitbearbeitung

D100 coating for graphite machining

AFD

Ø d ₁ [mm]	Z	fz [mm]	n 10000 min1 vf [mm/min.]	n 15000 min1 vf [mm/min.]	n 20000 min1 vf [mm/min.]	n 30000 min1 vf [mm/min.]
2,0	3	0,019	570	855	1140	1710
3,0	3	0,028	840	1260	1680	2520
4,0	3	0,038	1140	1710	2280	3420
5,0	3	0,047	1410	2115	2820	4230
6,0	3	0,056	1680	2520	3360	5040
8,0	3	0,075	2250	3375	4500	6750
10,0	3	0,094	2820	4230	5640	8460
12,0	3	0,113	3390	5085	6780	10170

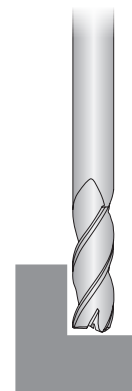

Schruppen
Roughing

Ø d ₁ [mm]	Z	fz [mm]	n 10000 min1 vf [mm/min.]	n 15000 min1 vf [mm/min.]	n 20000 min1 vf [mm/min.]	n 30000 min1 vf [mm/min.]
2,0	3	0,021	630	945	1260	1890
3,0	3	0,032	960	1140	1920	2880
4,0	3	0,043	1290	1935	2580	3870
5,0	3	0,053	1590	2385	3180	4770
6,0	3	0,064	1920	2880	3840	5760
8,0	3	0,085	2550	3825	5100	7650
10,0	3	0,107	3210	4815	6420	9630
12,0	3	0,128	3840	5760	7680	11520

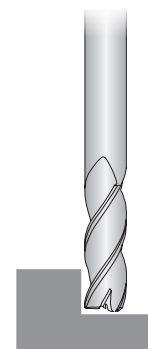

Schlichten
Finishing

Achtung:
Die angegebenen Schnittparameter sind Richt- und Startwerte.
Kundenspezifische Gegebenheiten wie Antriebsleistung, Maschinenstabilität,
Werkzeugauskragung etc. sind hierbei nicht berücksichtigt.

Attention:
These cutting data are recommendations only.
Customer specific circumstances such as machine power, stability,
tool overhang etc. are not taken into consideration.

AFD54031-...

D100-Beschichtung für Graphitbearbeitung

D100 coating for graphite machining

$\varnothing d_1$ [mm]	Z	fz [mm]	n 10000 min1 vf [mm/min.]	n 15000 min1 vf [mm/min.]	n 20000 min1 vf [mm/min.]	n 30000 min1 vf [mm/min.]
2,0	3	0,021	630	945	1260	1890
3,0	3	0,032	960	1440	1920	2880
4,0	3	0,043	1290	1935	2580	3870
5,0	3	0,053	1590	2385	3180	4770
6,0	3	0,064	1920	2880	3840	5760
8,0	3	0,085	2550	3825	5100	7650
10,0	3	0,107	3210	4815	6420	9630
12,0	3	0,128	3840	5760	7680	11520

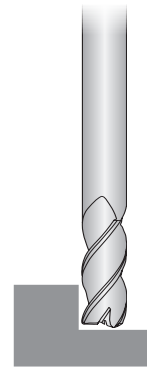
Schlichten
Finishing

AFD

Achtung:

Die angegebenen Schnittparameter sind Richt- und Startwerte.
Kundenspezifische Gegebenheiten wie Antriebsleistung, Maschinenstabilität,
Werkzeugauskragung etc. sind hierbei nicht berücksichtigt.

Attention:

These cutting data are recommendations only.
Customer specific circumstances such as machine power, stability,
tool overhang etc. are not taken into consideration.

Alle Angaben in mm / Dimensions in mm

AFD54031-...

DLC-Beschichtung für Aluminiumlegierungen

DLC coating for aluminium alloys

Ø d ₁ [mm]	Z	Vc m/min.	fz [mm]	n [U/min ¹]	vf [mm/min.]
2,0	3	170	0,012	27000	1000
3,0	3	200	0,017	21000	1100
4,0	3	190	0,026	15000	1200
5,0	3	190	0,034	12000	1250
6,0	3	190	0,046	10000	1400
8,0	3	190	0,066	7500	1500
10,0	3	190	0,094	6000	1700
12,0	3	190	0,110	5000	1700

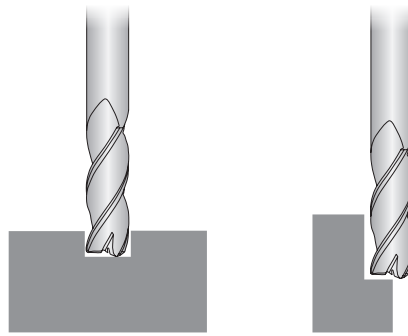

AFD

DLC-Beschichtung für Kupferlegierungen

DLC coating for copper alloys

Ø d ₁ [mm]	Z	Vc m/min.	fz [mm]	n [U/min ¹]	vf [mm/min.]
2,0	3	65	0,008	10000	240
3,0	3	75	0,013	8000	320
4,0	3	75	0,020	6000	360
5,0	3	75	0,026	4800	385
6,0	3	75	0,033	4000	400
8,0	3	75	0,050	3000	460
10,0	3	75	0,066	2400	480
12,0	3	75	0,080	2000	510

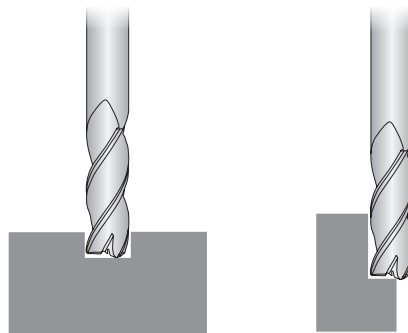

Achtung:
Die angegebenen Schnittparameter sind Richt- und Startwerte.
Kundenspezifische Gegebenheiten wie Antriebsleistung, Maschinenstabilität,
Werkzeugauskragung etc. sind hierbei nicht berücksichtigt.

Attention:
These cutting data are recommendations only.
Customer specific circumstances such as machine power, stability,
tool overhang etc. are not taken into consideration.

AFD51830-...

D100-Beschichtung für Graphitbearbeitung

D100 coating for graphite machining

Ø d ₁ [mm]	Z	fz [mm]	n 10000 min1 vf [mm/min.]	n 15000 min1 vf [mm/min.]	n 20000 min1 vf [mm/min.]	n 30000 min1 vf [mm/min.]
2,0	3	0,018	540	810	1080	1620
2,5	3	0,023	690	1035	1380	2070
3,0	3	0,028	840	1260	1680	2520
3,5	3	0,033	990	1485	1980	2970
4,0	3	0,038	1140	1710	2280	3420
5,0	3	0,047	1410	2115	2820	4230
6,0	3	0,056	1680	2520	3360	5040
8,0	3	0,075	2250	3375	4500	6750
10,0	3	0,094	2820	4230	5640	8460
12,0	3	0,113	3390	5085	6780	10170

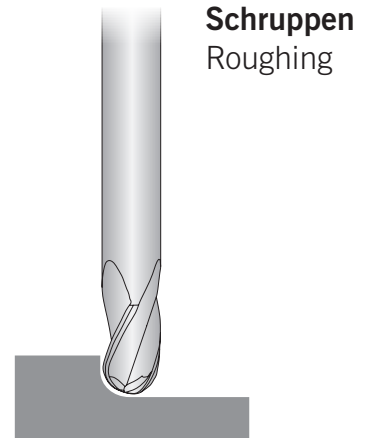

AFD

Ø d ₁ [mm]	Z	fz [mm]	n 10000 min1 vf [mm/min.]	n 15000 min1 vf [mm/min.]	n 20000 min1 vf [mm/min.]	n 30000 min1 vf [mm/min.]
2,0	3	0,015	450	675	900	1350
2,5	3	0,018	540	810	1080	1620
3,0	3	0,022	660	990	1320	1980
3,5	3	0,026	780	1170	1560	2340
4,0	3	0,029	870	1305	1740	2610
5,0	3	0,036	1080	1620	2160	3240
6,0	3	0,044	1320	1980	2640	3960
8,0	3	0,058	1740	2610	3480	5220
10,0	3	0,073	2190	3285	4380	6570
12,0	3	0,087	2610	3915	5220	7830

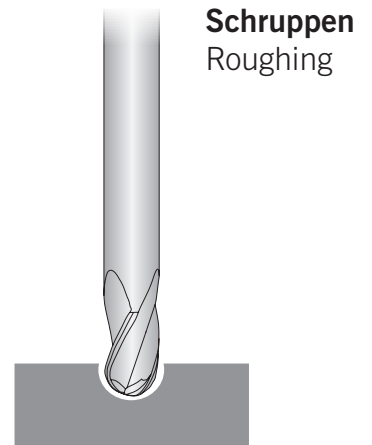

Achtung:
Die angegebenen Schnittparameter sind Richt- und Startwerte.
Kundenspezifische Gegebenheiten wie Antriebsleistung, Maschinenstabilität,
Werkzeugauskragung etc. sind hierbei nicht berücksichtigt.

Attention:
These cutting data are recommendations only.
Customer specific circumstances such as machine power, stability,
tool overhang etc. are not taken into consideration.

Alle Angaben in mm / Dimensions in mm

AFD51830-...

D100-Beschichtung für Graphitbearbeitung

D100 coating for graphite machining

AFD

Ø d ₁ [mm]	Z	fz [mm]	n 10000 min1 vf [mm/min.]	n 15000 min1 vf [mm/min.]	n 20000 min1 vf [mm/min.]	n 30000 min1 vf [mm/min.]
2,0	3	0,022	660	990	1320	1980
2,5	3	0,027	810	1215	1620	2430
3,0	3	0,032	960	1440	1920	2880
3,5	3	0,037	1110	1665	2220	3330
4,0	3	0,043	1290	1935	2580	3870
5,0	3	0,053	1590	2385	3180	4770
6,0	3	0,064	1920	2880	3840	5760
8,0	3	0,085	2550	3825	5100	7650
10,0	3	0,107	3210	4815	6420	9630
12,0	3	0,128	3840	5760	7680	11520

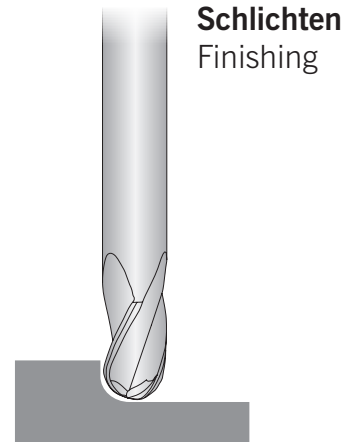

Ø d ₁ [mm]	Z	fz [mm]	n 10000 min1 vf [mm/min.]	n 15000 min1 vf [mm/min.]	n 20000 min1 vf [mm/min.]	n 30000 min1 vf [mm/min.]
2,0	3	0,022	660	990	1320	1980
2,5	3	0,027	810	1215	1620	2430
3,0	3	0,032	960	1440	1920	2880
3,5	3	0,037	1110	1665	2220	3330
4,0	3	0,043	1290	1935	2580	3870
5,0	3	0,053	1590	2385	3180	4770
6,0	3	0,064	1920	2880	3840	5760
8,0	3	0,085	2550	3825	5100	7650
10,0	3	0,107	3210	4815	6420	9630
12,0	3	0,128	3840	5760	7680	11520

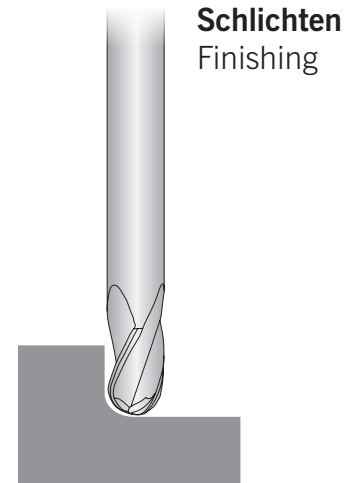

Achtung:
Die angegebenen Schnittparameter sind Richt- und Startwerte.
Kundenspezifische Gegebenheiten wie Antriebsleistung, Maschinenstabilität,
Werkzeugauskragung etc. sind hierbei nicht berücksichtigt.

Attention:
These cutting data are recommendations only.
Customer specific circumstances such as machine power, stability,
tool overhang etc. are not taken into consideration.

AFD51830-...

DLC-Beschichtung für Aluminiumlegierungen

DLC coating for aluminium alloys

$\varnothing d_1$ [mm]	Z	Vc m/min.	fz [mm]	n [U/min ¹]	vf [mm/min.]
2,0	3	160	0,020	25000	1000
3,0	3	160	0,029	17000	1000
4,0	3	160	0,040	12500	1000
5,0	3	160	0,060	10000	1200
6,0	3	160	0,080	8500	1350
7,0	3	175	0,090	8000	1450
8,0	3	175	0,100	7000	1450
9,0	3	180	0,110	6400	1400
10,0	3	188	0,120	6000	1450
12,0	3	188	0,140	5000	1450

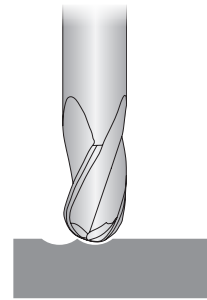

AFD

DLC-Beschichtung für Kupferlegierungen

DLC coating for copper alloys

$\varnothing d_1$ [mm]	Z	Vc m/min.	fz [mm]	n [U/min ¹]	vf [mm/min.]
2,0	3	120	0,020	19000	800
3,0	3	115	0,032	12500	800
4,0	3	120	0,042	9500	800
5,0	3	120	0,055	7600	850
6,0	3	120	0,070	6400	900
7,0	3	125	0,080	5700	900
8,0	3	130	0,090	5100	900
9,0	3	130	0,100	4600	900
10,0	3	130	0,110	4200	900
12,0	3	130	0,130	3500	900

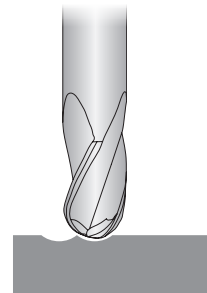
**Achtung:**

Die angegebenen Schnittparameter sind Richt- und Startwerte.
Kundenspezifische Gegebenheiten wie Antriebsleistung, Maschinenstabilität,
Werkzeugauskragung etc. sind hierbei nicht berücksichtigt.

Attention:

These cutting data are recommendations only.
Customer specific circumstances such as machine power, stability,
tool overhang etc. are not taken into consideration.

Alle Angaben in mm / Dimensions in mm

AFD50740-...

D100-Beschichtung für Graphitbearbeitung

D100 coating for graphite machining

AFD

Ø d ₁ [mm]	Z	fz [mm]	n 10000 min1 vf [mm/min.]	n 15000 min1 vf [mm/min.]	n 20000 min1 vf [mm/min.]	n 30000 min1 vf [mm/min.]
6,0	4	0,056	2240	3360	4460	6720
8,0	4	0,075	3000	4500	6000	9000
10,0	4	0,094	3760	5640	7520	11280
12,0	4	0,113	4520	6780	9040	13560

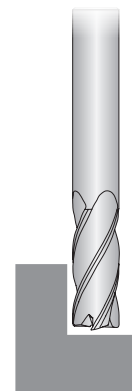

Schruppen
Roughing

Ø d ₁ [mm]	Z	fz [mm]	n 10000 min1 vf [mm/min.]	n 15000 min1 vf [mm/min.]	n 20000 min1 vf [mm/min.]	n 30000 min1 vf [mm/min.]
6,0	4	0,044	1760	2640	3520	5280
8,0	4	0,058	2320	3480	4640	6960
10,0	4	0,073	2920	4380	5840	8760
12,0	4	0,087	3480	5220	6960	10440

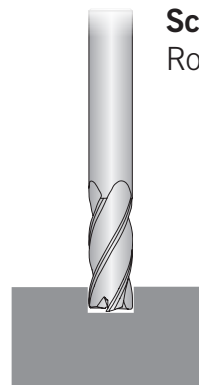

Schruppen
Roughing

Achtung:
Die angegebenen Schnittparameter sind Richt- und Startwerte.
Kundenspezifische Gegebenheiten wie Antriebsleistung, Maschinenstabilität,
Werkzeugauskragung etc. sind hierbei nicht berücksichtigt.

Attention:
These cutting data are recommendations only.
Customer specific circumstances such as machine power, stability,
tool overhang etc. are not taken into consideration.

AFD50740-...

D100-Beschichtung für Graphitbearbeitung

D100 coating for graphite machining

Ø d ₁ [mm]	Z	fz [mm]	n 10000 min1 vf [mm/min.]	n 15000 min1 vf [mm/min.]	n 20000 min1 vf [mm/min.]	n 30000 min1 vf [mm/min.]
6,0	4	0,080	3200	4800	6400	9600
8,0	4	0,107	4280	6420	8560	12840
10,0	4	0,133	5320	7980	10640	15960
12,0	4	0,160	6400	9600	12800	19200

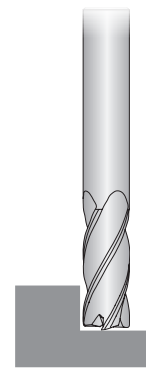

Schlichten
Finishing

AFD

Ø d ₁ [mm]	Z	fz [mm]	n 10000 min1 vf [mm/min.]	n 15000 min1 vf [mm/min.]	n 20000 min1 vf [mm/min.]	n 30000 min1 vf [mm/min.]
6,0	4	0,080	3200	4800	6400	9600
8,0	4	0,107	4280	6420	8560	12840
10,0	4	0,133	5320	7980	10640	15960
12,0	4	0,160	6400	9600	12800	19200

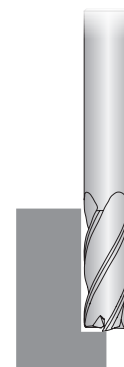

Schlichten
Finishing

Achtung:
Die angegebenen Schnittparameter sind Richt- und Startwerte.
Kundenspezifische Gegebenheiten wie Antriebsleistung, Maschinenstabilität,
Werkzeugauskragung etc. sind hierbei nicht berücksichtigt.

Attention:
These cutting data are recommendations only.
Customer specific circumstances such as machine power, stability,
tool overhang etc. are not taken into consideration.

Alle Angaben in mm / Dimensions in mm

AFD50740-...

DLC-Beschichtung für Aluminiumlegierungen

DLC coating for aluminium alloys

Ø d ₁ [mm]	Z	Vc m/min.	fz [mm]	n [U/min ¹]	vf [mm/min.]
6,0	4	190	0,046	10000	1850
8,0	4	190	0,066	7500	2000
10,0	4	190	0,093	6000	2250
12,0	4	190	0,112	5000	2250

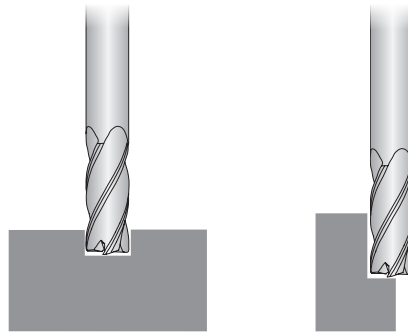

AFD

DLC-Beschichtung für Kupferlegierungen

DLC coating for copper alloys

Ø d ₁ [mm]	Z	Vc m/min.	fz [mm]	n [U/min ¹]	vf [mm/min.]
6,0	4	75	0,033	4000	530
8,0	4	75	0,050	3000	600
10,0	4	75	0,066	2400	640
12,0	4	75	0,085	2000	680

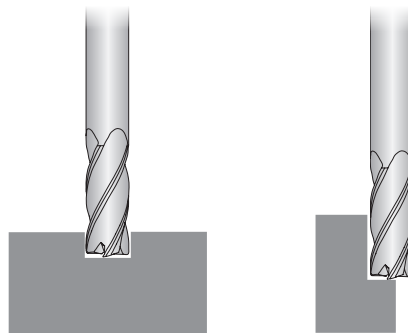

Achtung:
Die angegebenen Schnittparameter sind Richt- und Startwerte.
Kundenspezifische Gegebenheiten wie Antriebsleistung, Maschinenstabilität,
Werkzeugauskragung etc. sind hierbei nicht berücksichtigt.

Attention:
These cutting data are recommendations only.
Customer specific circumstances such as machine power, stability,
tool overhang etc. are not taken into consideration.

ARNO[®]

WERKZEUGE

We have a passion for precision.

AUSFÜHRUNG AFG

Design AFG

**Ausgezeichnet für die Bearbeitung
von Stählen und gehärteten Stählen.**

Excellent for machining steel and hardened steel.

Nicht nur bei der Bearbeitung von legierten und unlegierten Stählen leisten die AFG-Fräser ganze Arbeit, sondern auch bei gehärteten Stählen (bis 50 HRC) und anderen zähen Werkstoffen. Für die Trockenbearbeitung geeignet.



Not just for milling of alloy and non-alloy steel, but also for hard steel (up to 50 HRC) as well as other tough materials. Also suitable for dry machining.

VHM-Schaftfräser

2 Schneiden, kurze Ausführung

Solid carbide end-mill

2 flutes, short design



2



30°



HA

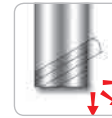

Seite
Page
183-192



TiAlN



Feinstkorn
Ultra micro
granulation



P	●	N
M	●	S
K		H

AFG50120-...

Schaft / Shank DIN 6535HA	d	d _A	l ₁	l
AFG50120-020B	2,0	6	6,0	40
AFG50120-030	3,0	6	8,0	45
AFG50120-040	4,0	6	11,0	45
AFG50120-050	5,0	6	13,0	50
AFG50120-060	6,0	6	13,0	50
AFG50120-080	8,0	8	19,0	60
AFG50120-100	10,0	10	22,0	70
AFG50120-120	12,0	12	26,0	75
AFG50120-140	14,0	14	26,0	85
AFG50120-160	16,0	16	32,0	100
AFG50120-180	18,0	18	32,0	100
AFG50120-200	20,0	20	38,0	105
AFG50120-220	22,0	20	38,0	105
AFG50120-250	25,0	25	45,0	120

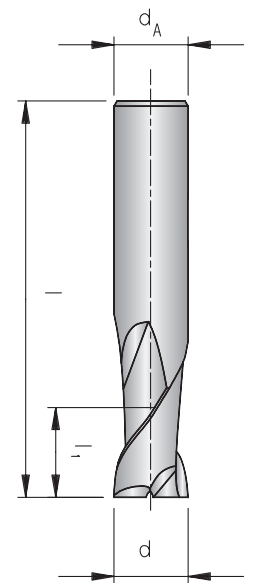

Toleranz / Tolerance	
Fräser / Mill	0 -0,03
Schaft / Shank	h6

VHM-Schaftfräser

2 Schneiden, lange Ausführung



Solid carbide end-mill

2 flutes, long design

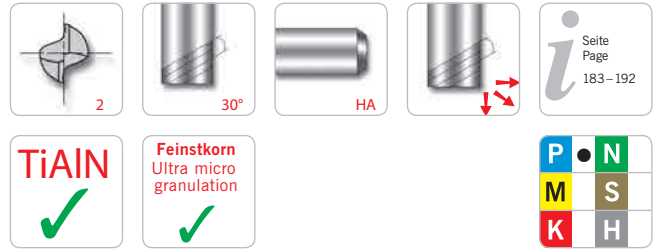

Seite
Page
183-192

P	●	N
M		S
K		H

AFG50121-...

Schaft / Shank DIN 6535HA	d	d _A	l ₁	l
AFG50121-020	2,0	4	8,0	40
AFG50121-030	3,0	6	12,0	50
AFG50121-040	4,0	6	15,0	50
AFG50121-050	5,0	6	20,0	60
AFG50121-060	6,0	6	20,0	60
AFG50121-080	8,0	8	25,0	70
AFG50121-100	10,0	10	30,0	90
AFG50121-120	12,0	12	30,0	90
AFG50121-140	14,0	16	40,0	110
AFG50121-160	16,0	16	50,0	110
AFG50121-180	18,0	20	50,0	110
AFG50121-200	20,0	20	55,0	110
AFG50121-250	25,0	25	75,0	140

Toleranz / Tolerance	
Fräser / Mill	0 -0,03
Schaft / Shank	h6

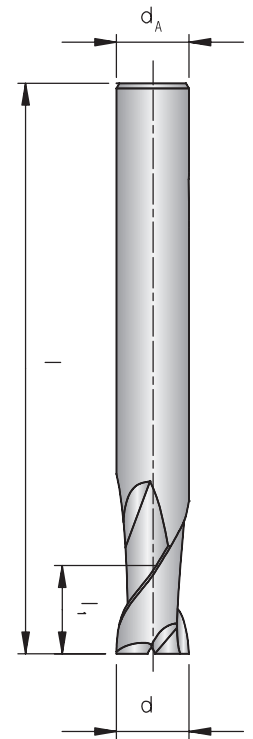

AFG

● = Hauptanwendung / Main application
○ = Nebenanwendung / Suitable

Alle Angaben in mm / Dimensions in mm

VHM-Radiusfräser

2 Schneiden, lange Ausführung

Solid carbide ball-nose end-mill

2 flutes, long design

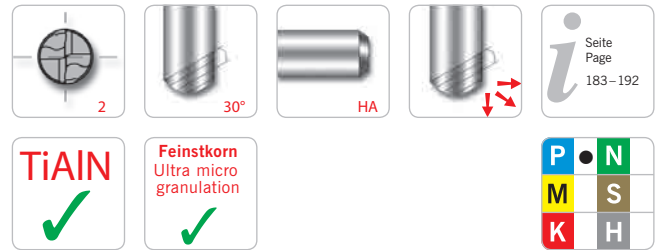

AFG

AFG50321-...

Schaft / Shank DIN 6535HA	d	d _A	l ₁	l
AFG50321-020	2,0	6	5,0	50
AFG50321-030	3,0	6	8,0	60
AFG50321-040	4,0	6	8,0	70
AFG50321-050	5,0	6	10,0	80
AFG50321-060	6,0	6	12,0	90
AFG50321-080	8,0	8	14,0	100
AFG50321-100	10,0	10	18,0	100
AFG50321-120	12,0	12	22,0	110
AFG50321-140	14,0	14	26,0	110
AFG50321-160	16,0	16	30,0	140
AFG50321-180	18,0	18	34,0	140
AFG50321-200	20,0	20	38,0	160
AFG50321-250	25,0	25	50,0	180

Toleranz / Tolerance

Fräser / Mill	0
Schaft / Shank	-0,03
	h6

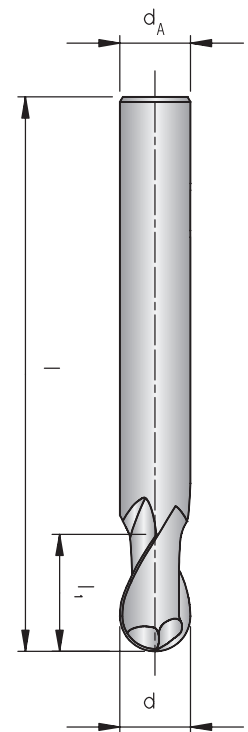

● = Hauptanwendung / Main application
○ = Nebenanwendung / Suitable

Alle Angaben in mm / Dimensions in mm

VHM-Radiusfräser

2 Schneiden, mit konischem Schaffteil

Solid carbide ball-nose end-mill

2 flutes, with taper neck

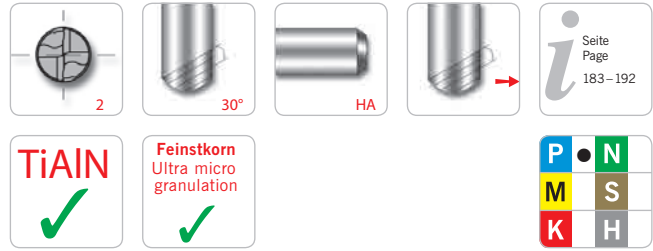

AFG50322-...

Schaft / Shank DIN 6535HA	d	d _A	d ₃	l ₁	l ₂	l ₃	l	R	A
AFG50322-010A	1,0	6	2,00	2,0	4	23	60	0,50	1°30'
AFG50322-010B	1,0	6	4,30	2,0	4	23	60	0,50	5°
AFG50322-010C	1,0	6	5,00	2,0	4	42	80	0,50	3°
AFG50322-020A	2,0	6	2,90	4,0	6	23	60	1,00	1°30'
AFG50322-020B	2,0	6	5,00	4,0	6	23	60	1,00	5°
AFG50322-020C	2,0	6	5,70	4,0	6	41	80	1,00	3°
AFG50322-030A	3,0	6	5,60	6,0	8	32	70	1,50	3°
AFG50322-030B	3,0	6	5,30	6,0	8	52	90	1,50	1°30'
AFG50322-040A	4,0	6	6,00	8,0	10	28	70	2,00	3°
AFG50322-040B	4,0	6	6,00	8,0	10	49	90	2,00	1°30'
AFG50322-050A	5,0	8	8,00	10,0	12	41	90	2,50	3°
AFG50322-050B	5,0	8	7,00	10,0	12	61	110	2,50	1°30'
AFG50322-060A	6,0	8	8,00	12,0	15	34	90	3,00	3°
AFG50322-060B	6,0	8	8,00	12,0	15	53	110	3,00	1°30'
AFG50322-080A	8,0	10	10,00	14,0	17	36	100	4,00	3°
AFG50322-080B	8,0	10	10,00	14,0	17	55	120	4,00	1°30'
AFG50322-100A	10,0	12	12,00	18,0	21	40	110	5,00	3°
AFG50322-100B	10,0	12	12,00	18,0	21	59	130	5,00	1°30'
AFG50322-120A	12,0	16	16,00	22,0	25	63	140	6,00	3°
AFG50322-120B	12,0	16	15,00	22,0	25	83	160	6,00	1°30'

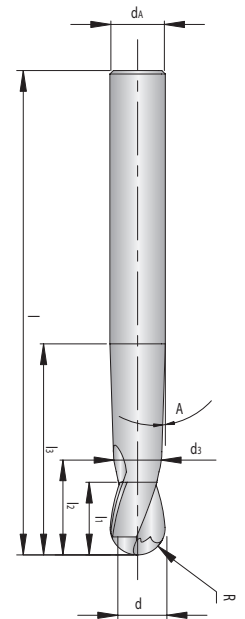

Toleranz / Tolerance	
Fräser / Mill	0 -0,03
Radius / Radius	± 0,01
Schaft / Shank	h6

● = Hauptanwendung / Main application
○ = Nebenanwendung / Suitable

Alle Angaben in mm / Dimensions in mm

VHM-Radiusfräser

2 Schneiden, lange Ausführung (Schlitzfräsen)

Solid carbide ball-nose end-mill

2 flutes, long design (Slotting)

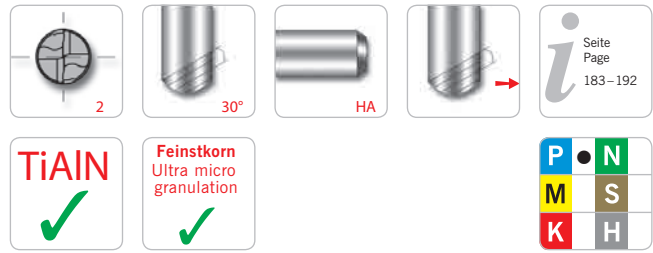

AFG

AFG52021-...

Schaft / Shank DIN 6535HA	d	d _A	d ₃	l ₁	l ₂	l
AFG52021-004A	0,4	4	0,37	0,6	1	45
AFG52021-004B	0,4	4	0,37	0,6	2	45
AFG52021-004C	0,4	4	0,37	0,6	3	45
AFG52021-005A	0,5	4	0,45	0,7	2	45
AFG52021-005B	0,5	4	0,45	0,7	4	45
AFG52021-005C	0,5	4	0,45	0,7	6	45
AFG52021-005D	0,5	4	0,45	0,7	8	45
AFG52021-006A	0,6	4	0,55	0,9	2	45
AFG52021-006B	0,6	4	0,55	0,9	4	45
AFG52021-006C	0,6	4	0,55	0,9	6	35
AFG52021-006D	0,6	4	0,55	0,9	6	45
AFG52021-006E	0,6	4	0,55	0,9	8	45
AFG52021-008A	0,8	4	0,75	1,2	2	45
AFG52021-008B	0,8	4	0,75	1,2	4	45
AFG52021-008C	0,8	4	0,75	1,2	6	45
AFG52021-008D	0,8	4	0,75	1,2	8	45
AFG52021-008E	0,8	4	0,75	1,2	10	45
AFG52021-010A	1,0	4	0,95	1,5	3	45
AFG52021-010B	1,0	4	0,95	1,5	4	45
AFG52021-010C	1,0	4	0,95	1,5	5	45
AFG52021-010D	1,0	4	0,95	1,5	6	45
AFG52021-010E	1,0	4	0,95	1,5	7	45
AFG52021-010F	1,0	4	0,95	1,5	8	45
AFG52021-010G	1,0	4	0,95	1,5	9	45
AFG52021-010H	1,0	4	0,95	1,5	10	45
AFG52021-010I	1,0	4	0,95	1,5	12	45
AFG52021-010J	1,0	4	0,95	1,5	14	50
AFG52021-010K	1,0	4	0,95	1,5	16	50
AFG52021-010L	1,0	4	0,95	1,5	20	55
AFG52021-012A	1,2	4	1,15	1,8	8	45
AFG52021-012B	1,2	4	1,15	1,8	12	45
AFG52021-014A	1,4	4	1,35	2,1	8	45
AFG52021-014B	1,4	4	1,35	2,1	12	45
AFG52021-014C	1,4	4	1,35	2,1	16	50
AFG52021-015A	1,5	4	1,45	2,3	6	45
AFG52021-015B	1,5	4	1,45	2,3	8	45
AFG52021-015C	1,5	4	1,45	2,3	10	45
AFG52021-015D	1,5	4	1,45	2,3	12	45
AFG52021-015E	1,5	4	1,45	2,3	16	50
AFG52021-015F	1,5	4	1,45	2,3	20	55
AFG52021-016A	1,6	4	1,55	2,4	8	45
AFG52021-016B	1,6	4	1,55	2,4	12	45
AFG52021-016C	1,6	4	1,55	2,4	16	50

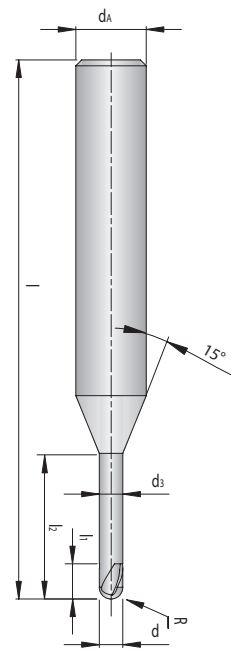

● = Hauptanwendung / Main application
○ = Nebenanwendung / Suitable

Alle Angaben in mm / Dimensions in mm

VHM-Radiusfräser

2 Schneiden, lange Ausführung (Schlitzfräsen)

Solid carbide ball-nose end-mill

2 flutes, long design (Slotting)

AFG52021-...

Schaft / Shank DIN 6535HA	d	d _A	d ₃	l ₁	l ₂	l
AFG52021-016D	1,6	4	1,55	2,4	20	55
AFG52021-018A	1,8	4	1,75	2,7	8	45
AFG52021-018B	1,8	4	1,75	2,7	12	45
AFG52021-018C	1,8	4	1,75	2,7	16	50
AFG52021-018D	1,8	4	1,75	2,7	20	55
AFG52021-020A	2,0	4	1,95	3,0	4	45
AFG52021-020B	2,0	4	1,95	3,0	6	45
AFG52021-020C	2,0	4	1,95	3,0	8	45
AFG52021-020D	2,0	4	1,95	3,0	10	45
AFG52021-020E	2,0	4	1,95	3,0	12	50
AFG52021-020F	2,0	4	1,95	3,0	14	50
AFG52021-020G	2,0	4	1,95	3,0	16	50
AFG52021-020H	2,0	4	1,95	3,0	20	55
AFG52021-020I	2,0	4	1,95	3,0	22	60
AFG52021-020J	2,0	4	1,95	3,0	25	60
AFG52021-020K	2,0	4	1,95	3,0	30	70
AFG52021-030A	3,0	6	2,85	4,5	8	50
AFG52021-030B	3,0	6	2,85	4,5	10	50
AFG52021-030C	3,0	6	2,85	4,5	12	50
AFG52021-030D	3,0	6	2,85	4,5	16	55
AFG52021-030E	3,0	6	2,85	4,5	20	60
AFG52021-030F	3,0	6	2,85	4,5	25	65
AFG52021-030G	3,0	6	2,85	4,5	30	70
AFG52021-030H	3,0	6	2,85	4,5	35	80
AFG52021-040A	4,0	6	3,85	6,0	10	60
AFG52021-040B	4,0	6	3,85	6,0	12	60
AFG52021-040C	4,0	6	3,85	6,0	16	60
AFG52021-040D	4,0	6	3,85	6,0	20	65
AFG52021-040E	4,0	6	3,85	6,0	25	70
AFG52021-040F	4,0	6	3,85	6,0	30	70
AFG52021-040G	4,0	6	3,85	6,0	35	80
AFG52021-040H	4,0	6	3,85	6,0	40	90
AFG52021-040I	4,0	6	3,85	6,0	45	90
AFG52021-040J	4,0	6	3,85	6,0	50	100
AFG52021-050A	5,0	6	4,85	7,5	16	60
AFG52021-050B	5,0	6	4,85	7,5	20	60
AFG52021-050C	5,0	6	4,85	7,5	25	70
AFG52021-050D	5,0	6	4,85	7,5	30	80
AFG52021-050E	5,0	6	4,85	7,5	35	80
AFG52021-060A	6,0	6	5,85	9,0	20	80
AFG52021-060B	6,0	6	5,85	9,0	30	90
AFG52021-060C	6,0	6	5,85	9,0	40	100
AFG52021-060D	6,0	6	5,85	9,0	50	110

Toleranz / Tolerance

Fräser / Mill	0 -0,02
Radius / Radius	± 0,01
Schaft / Shank	h6

● = Hauptanwendung / Main application
○ = Nebenanwendung / Suitable

Alle Angaben in mm / Dimensions in mm

VHM-Radiusfräser

2 Schneiden, lange Ausführung

Solid carbide ball-nose end-mill

2 flutes, long design

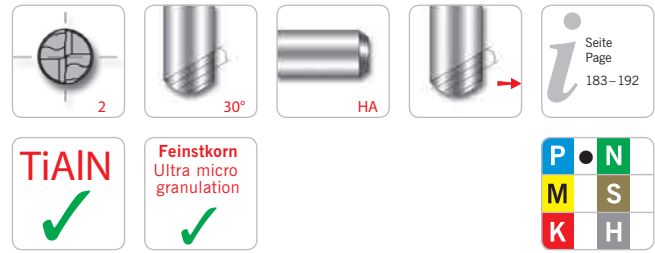

AFG

AFG51621-...

Schaft / Shank DIN 6535HA	d	d _A	d ₃	l ₁	l ₂	l
AFG51621-030	3,0	6	2,50	2,3	30	80
AFG51621-040	4,0	6	3,30	3,1	30	80
AFG51621-050	5,0	6	4,10	3,9	38	80
AFG51621-060	6,0	6	4,70	4,9	28	100
AFG51621-080	8,0	8	6,50	6,3	33	100
AFG51621-100	10,0	10	8,20	7,9	40	100
AFG51621-120	12,0	12	9,80	9,5	49	100

Toleranz / Tolerance	
Fräser / Mill	0 -0,03
Radius / Radius	± 0,01
Schaft / Shank	h6

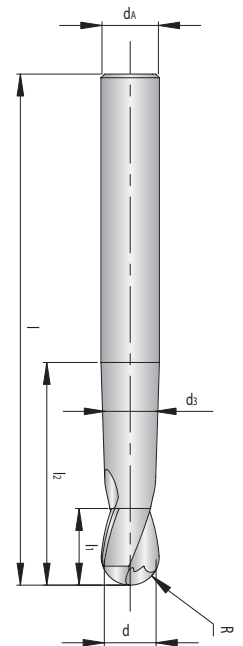

VHM-Schaftfräser

3 Schneiden, Mini-Ausführung



N NEU/NEW

Solid carbide end-mill

3 flutes, mini design

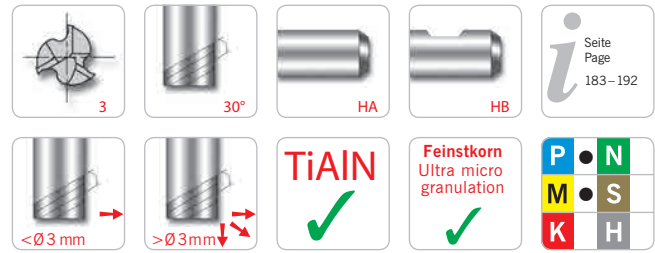

AFG50134-... / AFG60134-...

Schaft / Shank DIN 6535HA / HB	d	d _A	l ₁	l
AFG50134-015* N	1,5	4	2,0	35
AFG50134-020* N	2,0	4	4,0	35
AFG60134-030 N	3,0	6	5,0	36
AFG60134-040 N	4,0	6	7,0	38
AFG60134-050 N	5,0	6	8,0	39
AFG60134-060 N	6,0	6	8,0	39
AFG60134-080 N	8,0	8	11,0	43
AFG60134-100 N	10,0	10	13,0	50
AFG60134-120 N	12,0	12	15,0	55

Toleranz / Tolerance

Fräser / Mill	0 -0,03
Schaft / Shank	h6

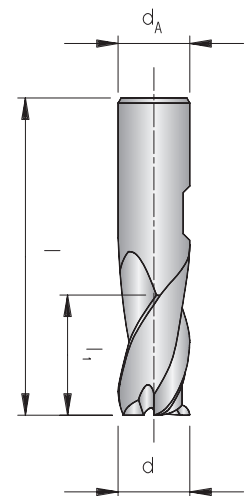

* Zylinderschaft nach DIN 6535HA ohne Mitnahmefläche

* Cylindrical shank to DIN 6535HA, no flat

● = Hauptanwendung / Main application
○ = Nebenanwendung / Suitable

Alle Angaben in mm / Dimensions in mm

VHM-Schaftfräser

4 Schneiden, mit Eckenradius

Solid carbide end-mill

4 flutes, with corner radius

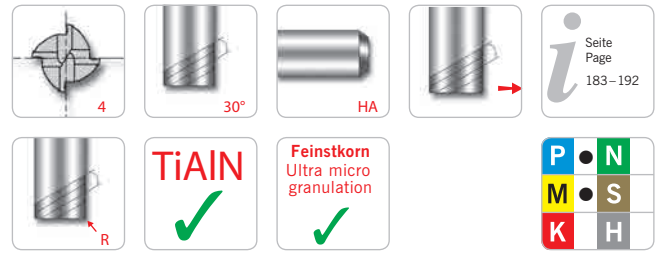

AFG

AFG50745-...R...

Schaft / Shank DIN 6535HA	d	d _A	d ₃	l ₁	l ₂	l	R
AFG50745-020R0,2	2,0	6	1,90	2,5	5	50	0,20
AFG50745-025R0,25	2,5	6	2,40	3,0	6	50	0,25
AFG50745-030R0,3	3,0	6	2,80	4,0	7	50	0,30
AFG50745-035R0,35	3,5	6	3,20	4,5	8	50	0,35
AFG50745-040R0,4	4,0	6	3,70	5,0	9	50	0,40
AFG50745-050R0,5	5,0	6	4,60	6,0	12	50	0,50
AFG50745-060R0,6	6,0	6	5,60	7,0	14	55	0,60
AFG50745-080R0,8	8,0	8	7,40	10,0	18	60	0,80
AFG50745-100R1,0	10,0	10	9,40	12,0	25	70	1,00
AFG50745-120R1,2	12,0	12	11,40	15,0	30	80	1,20
AFG50745-160R1,6	16,0	16	15,40	18,0	35	90	1,60

Toleranz / Tolerance	
Fräser / Mill	0 -0,03
Radius / Radius	± 0,01
Schaft / Shank	h6

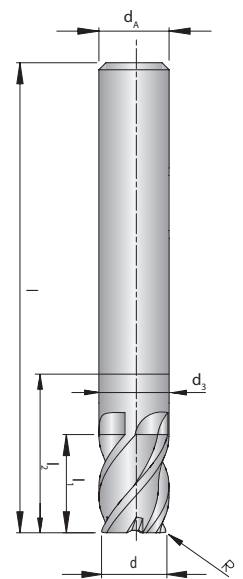

VHM-Schaftfräser

4 Schneiden, kurze Ausführung

Solid carbide end-mill

4 flutes, short design

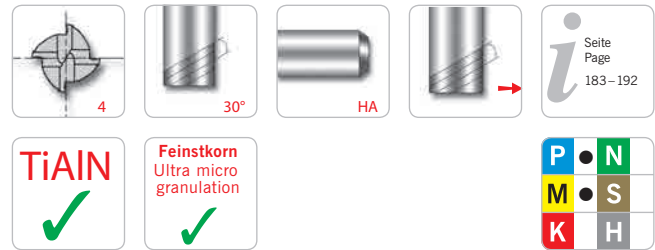

AFG50140-...

Schaft / Shank DIN 6535HA	d	d _A	l ₁	l
AFG50140-020A N	2,0	4	6,0	40
AFG50140-020B	2,0	6	6,0	40
AFG50140-025A N	2,5	4	8,0	40
AFG50140-030	3,0	6	8,0	45
AFG50140-040	4,0	6	11,0	45
AFG50140-050	5,0	6	13,0	50
AFG50140-060	6,0	6	13,0	50
AFG50140-080	8,0	8	19,0	60
AFG50140-100	10,0	10	22,0	70
AFG50140-120	12,0	12	26,0	75
AFG50140-140	14,0	14	26,0	85
AFG50140-160	16,0	16	32,0	100
AFG50140-180	18,0	18	32,0	100
AFG50140-200	20,0	20	38,0	105
AFG50140-220	22,0	20	38,0	105
AFG50140-250	25,0	25	45,0	120

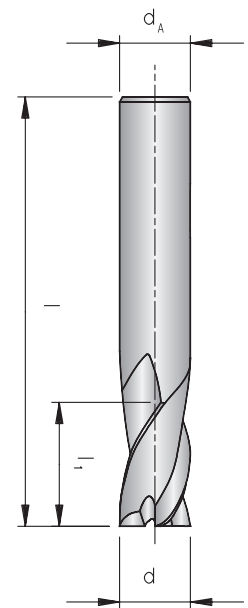

Toleranz / Tolerance	
Fräser / Mill	0 -0,03
Schaft / Shank	h6

● = Hauptanwendung / Main application
○ = Nebenanwendung / Suitable

Alle Angaben in mm / Dimensions in mm

VHM-Schaftfräser

4 Schneiden, kurze Ausführung

Solid carbide end-mill

4 flutes, short design



N NEU/NEW

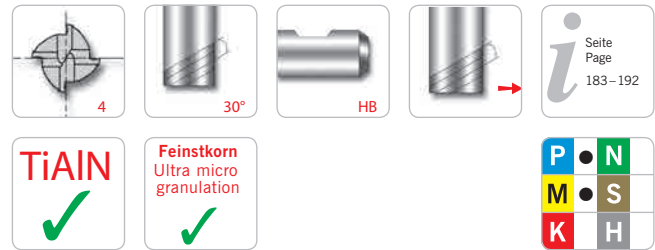

Seite
Page
183-192



AFG60140-...

Schaft / Shank DIN 6535HB	d	d _A	l ₁	l
AFG60140-020B N	2,0	6	6,0	40
AFG60140-030 N	3,0	6	8,0	45
AFG60140-040 N	4,0	6	11,0	45
AFG60140-050 N	5,0	6	13,0	50
AFG60140-060 N	6,0	6	13,0	50
AFG60140-080 N	8,0	8	19,0	60
AFG60140-100 N	10,0	10	22,0	70
AFG60140-120 N	12,0	12	26,0	75
AFG60140-140 N	14,0	14	26,0	85
AFG60140-160 N	16,0	16	32,0	100
AFG60140-180 N	18,0	18	32,0	100
AFG60140-200 N	20,0	20	38,0	105

Toleranz / Tolerance	
Fräser / Mill	0 -0,03
Schaft / Shank	h6

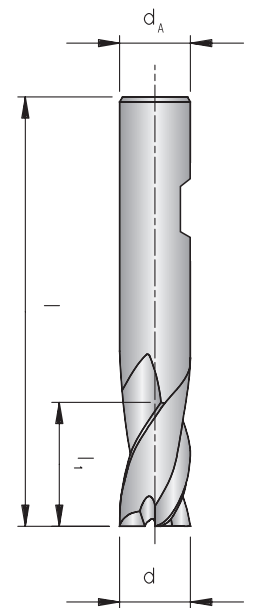

VHM-Schaftfräser

4 Schneiden, lange Ausführung, mit Eckenradius



Solid carbide end-mill

4 flutes, long design, with corner radius

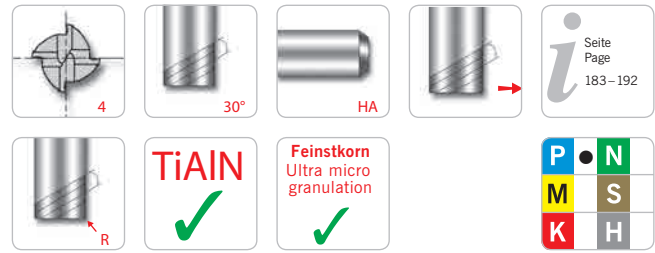

AFG50741-...R...

Schaft / Shank DIN 6535HA	d	d _A	l ₁	l	R
AFG50741-030R0,3	3,0	6	12,0	50	0,30
AFG50741-040R0,3	4,0	6	15,0	50	0,30
AFG50741-040R0,5	4,0	6	15,0	50	0,50
AFG50741-050R0,3	5,0	6	20,0	60	0,30
AFG50741-050R0,5	5,0	6	20,0	60	0,50
AFG50741-060R0,3	6,0	6	20,0	60	0,30
AFG50741-060R0,5	6,0	6	20,0	60	0,50
AFG50741-060R1,0	6,0	6	20,0	60	1,00
AFG50741-080R0,3	8,0	8	25,0	70	0,30
AFG50741-080R0,5	8,0	8	25,0	70	0,50
AFG50741-080R1,0	8,0	8	25,0	70	1,00
AFG50741-080R1,5	8,0	8	25,0	70	1,50
AFG50741-080R2,0	8,0	8	25,0	70	2,00
AFG50741-100R0,3	10,0	10	30,0	90	0,30
AFG50741-100R0,5	10,0	10	30,0	90	0,50
AFG50741-100R1,0	10,0	10	30,0	90	1,00
AFG50741-100R1,5	10,0	10	30,0	90	1,50
AFG50741-100R2,0	10,0	10	30,0	90	2,00
AFG50741-120R0,5	12,0	12	30,0	90	0,50
AFG50741-120R1,0	12,0	12	30,0	90	1,00
AFG50741-120R1,5	12,0	12	30,0	90	1,50
AFG50741-120R2,0	12,0	12	30,0	90	2,00
AFG50741-160R0,5	16,0	16	50,0	110	0,50
AFG50741-160R1,0	16,0	16	50,0	110	1,00
AFG50741-160R1,5	16,0	16	50,0	110	1,50
AFG50741-160R2,0	16,0	16	50,0	110	2,00
AFG50741-200R0,5	20,0	20	55,0	110	0,50
AFG50741-200R1,0	20,0	20	55,0	110	1,00
AFG50741-200R1,5	20,0	20	55,0	110	1,50
AFG50741-200R2,0	20,0	20	55,0	110	2,00

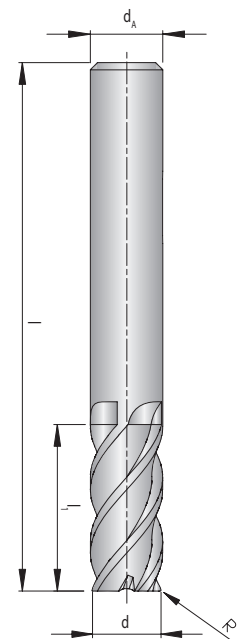

Toleranz / Tolerance	
Fräser / Mill	0 -0,03
Radius / Radius	± 0,01
Schaft / Shank	h6

● = Hauptanwendung / Main application
○ = Nebenanwendung / Suitable

Alle Angaben in mm / Dimensions in mm

VHM-Schaftfräser

4 Schneiden, lange Ausführung

Solid carbide end-mill

4 flutes, long design

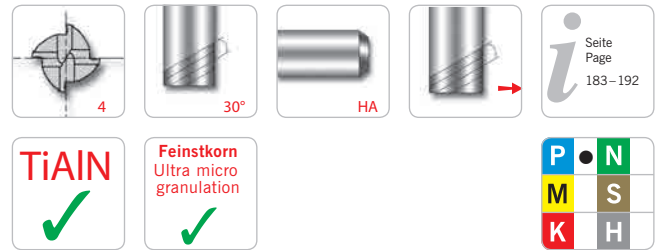

AFG50141-...

Schaft / Shank DIN 6535HA	d	d _A	l ₁	l
AFG50141-020	2,0	4	8,0	40
AFG50141-030	3,0	6	12,0	50
AFG50141-040	4,0	6	15,0	50
AFG50141-050	5,0	6	20,0	60
AFG50141-060	6,0	6	20,0	60
AFG50141-080	8,0	8	25,0	70
AFG50141-100	10,0	10	30,0	90
AFG50141-120	12,0	12	30,0	90
AFG50141-140	14,0	16	40,0	110
AFG50141-160	16,0	16	50,0	110
AFG50141-180	18,0	20	50,0	110
AFG50141-200	20,0	20	55,0	110
AFG50141-250	25,0	25	75,0	140

Toleranz / Tolerance	
Fräser / Mill	0 -0,03
Schaft / Shank	h6

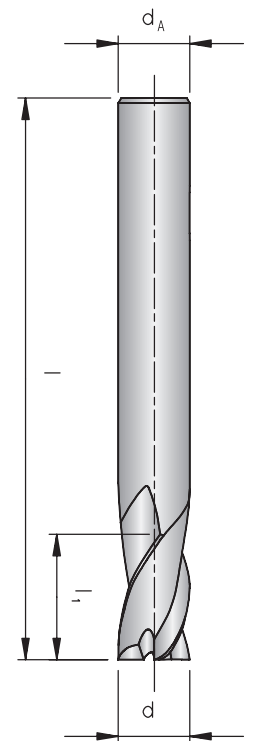

VHM-Schaftfräser

4 Schneiden, lange Ausführung



Solid carbide end-mill

4 flutes, long design

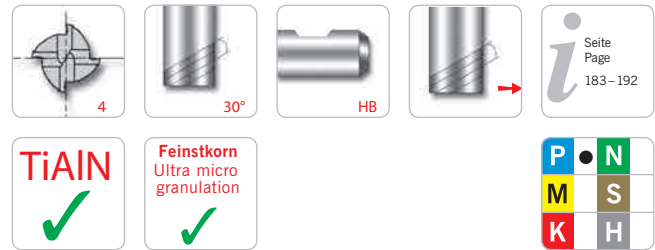

AFG60141-...

Schaft / Shank DIN 6535HB	d	d _A	l ₁	l
AFG60141-030	3,0	6	12,0	50
AFG60141-040	4,0	6	15,0	50
AFG60141-050	5,0	6	20,0	60
AFG60141-060	6,0	6	20,0	60
AFG60141-080	8,0	8	25,0	70
AFG60141-100	10,0	10	30,0	90
AFG60141-120	12,0	12	30,0	90
AFG60141-140	14,0	16	40,0	110
AFG60141-160	16,0	16	50,0	110
AFG60141-180	18,0	20	50,0	110
AFG60141-200	20,0	20	55,0	110
AFG60141-250	25,0	25	75,0	140

Toleranz / Tolerance	
Fräser / Mill	0 -0,03
Schaft / Shank	h6

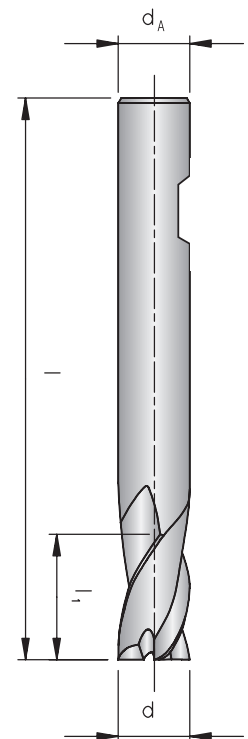

AFG

● = Hauptanwendung / Main application
○ = Nebenanwendung / Suitable

Alle Angaben in mm / Dimensions in mm

VHM-Schaftfräser

4 - 8 Schneiden, lange Ausführung

Solid carbide end-mill

4 - 8 flutes, long design



AFG

AFG502.0-...

Schaft / Shank DIN 6535HA	d	d _A	l ₁	l	z
AFG50240-040	4,0	6	11,0	57	4
AFG50260-060	6,0	6	13,0	57	6
AFG50260-080	8,0	8	19,0	63	6
AFG50260-100	10,0	10	22,0	72	6
AFG50260-120	12,0	12	26,0	83	6
AFG50260-140	14,0	14	26,0	83	6
AFG50260-160	16,0	16	32,0	92	6
AFG50280-180	18,0	18	32,0	92	8
AFG50280-200	20,0	20	38,0	104	8
AFG50280-250	25,0	25	44,0	104	8

Toleranz / Tolerance	
Fräser / Mill	0 -0,03
Schaft / Shank	h6

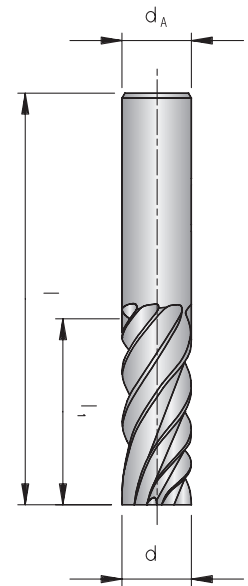

VHM-Schaftfräser

6-8 Schneiden, extra lange Ausführung

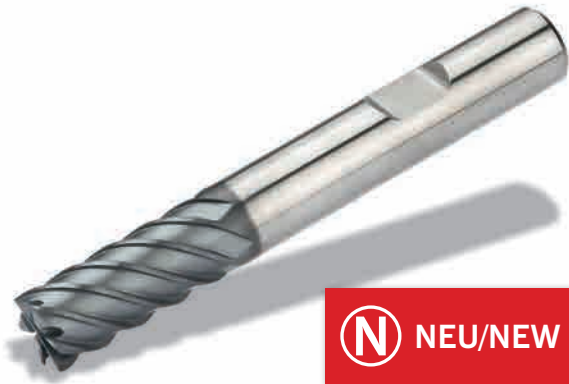

Solid carbide end-mill

6-8 flutes, extra long design

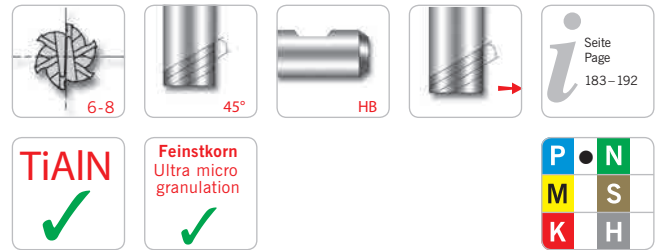

AFG602.0-...

Schaft / Shank DIN 6535HB	d	d _A	l ₁	l	z
AFG60240-040 N	4,0	6	11,0	57	4
AFG60260-060 N	6,0	6	13,0	57	6
AFG60260-070 N	7,0	8	16,0	63	6
AFG60260-080 N	8,0	8	19,0	63	6
AFG60260-100 N	10,0	10	22,0	72	6
AFG60260-120 N	12,0	12	26,0	83	6
AFG60260-140 N	14,0	14	26,0	83	6
AFG60260-160 N	16,0	16	32,0	92	6
AFG60280-180 N	18,0	18	32,0	92	8
AFG60280-200 N	20,0	20	38,0	104	8
AFG60280-250 N	25,0	25	44,0	104	8

Toleranz / Tolerance	
Fräser / Mill	0 -0,03
Schaft / Shank	h6

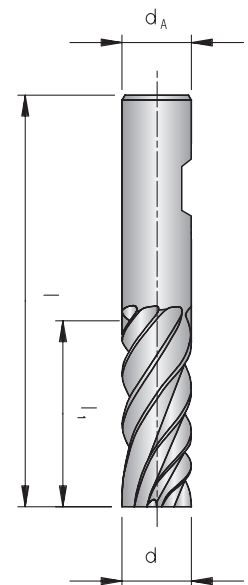

AFG

● = Hauptanwendung / Main application
○ = Nebenanwendung / Suitable

Alle Angaben in mm / Dimensions in mm

VHM-Schaftfräser

6 Schneiden, lange Ausführung, mit Eckenradius

Solid carbide end-mill

6 flutes, long design, with corner radius

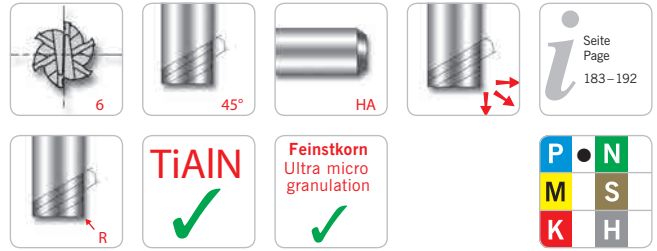

Seite
Page
183-192



AFG

AFG50861-...R...

Schaft / Shank DIN 6535HA	d	d _A	l ₁	l	R
AFG50861-060R0,5	6,0	6	13,0	70	0,50
AFG50861-080R0,5	8,0	8	19,0	90	0,50
AFG50861-100R0,5	10,0	10	22,0	100	0,50
AFG50861-100R1,0	10,0	10	22,0	100	1,00
AFG50861-120R0,5	12,0	12	26,0	110	0,50
AFG50861-120R1,0	12,0	12	26,0	110	1,00
AFG50861-160R1,0	16,0	16	32,0	130	1,00
AFG50861-160R1,5	16,0	16	32,0	130	1,50
AFG50861-200R1,0	20,0	20	38,0	140	1,00
AFG50861-200R1,5	20,0	20	38,0	140	1,50
AFG50861-200R2,0	20,0	20	38,0	140	2,00

Toleranz / Tolerance	
Fräser / Mill	0 -0,03
Radius / Radius	± 0,01
Schaft / Shank	h6

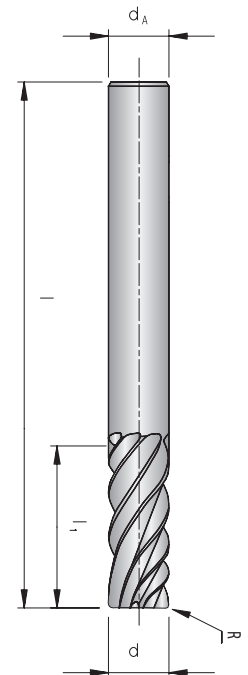

VHM-Schaftfräser

6 Schneiden, extra lange Ausführung



Solid carbide end-mill

6 flutes, extra long design

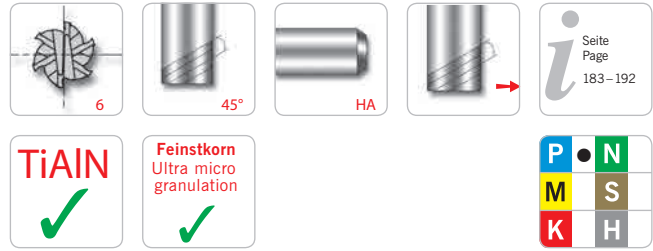

AFG50262-...

Schaft / Shank DIN 6535HA	d	d _A	l ₁	l
AFG50262-060	6,0	6	26,0	70
AFG50262-080	8,0	8	36,0	90
AFG50262-100	10,0	10	46,0	100
AFG50262-120	12,0	12	56,0	110
AFG50262-160	16,0	16	66,0	130
AFG50262-200	20,0	20	76,0	140
AFG50262-250	25,0	25	92,0	180

Toleranz / Tolerance	
Fräser / Mill	0 -0,03
Schaft / Shank	h6

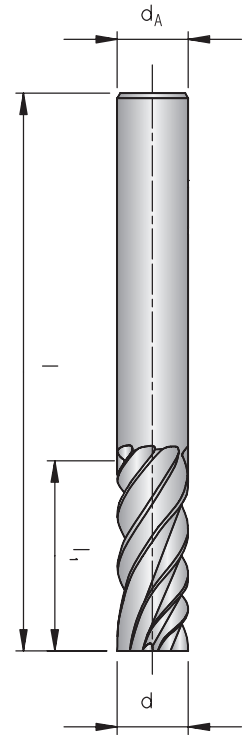

AFG

● = Hauptanwendung / Main application
○ = Nebenanwendung / Suitable

Alle Angaben in mm / Dimensions in mm

VHM-Schaftfräser

6 Schneiden, extra lange Ausführung

Solid carbide end-mill

6 flutes, extra long design



N NEU/NEW



6



45°



HB

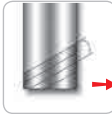

i

Seite
Page
183-192

TiAlN

✓

Feinstkorn
Ultra micro
granulation

✓

P	●	N
M		S
K		H

AFG60262-...

Schaft / Shank DIN 6535HB	d	d _A	l ₁	l
AFG60262-060 N	6,0	6	26,0	70
AFG60262-080 N	8,0	8	36,0	90
AFG60262-100 N	10,0	10	46,0	100
AFG60262-120 N	12,0	12	56,0	110
AFG60262-160 N	16,0	16	66,0	130
AFG60262-200 N	20,0	20	76,0	140
AFG60262-250 N	25,0	25	92,0	180

Toleranz / Tolerance	
Fräser / Mill	0 -0,03
Schaft / Shank	h6

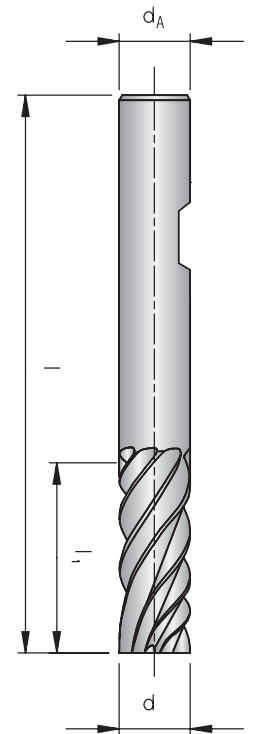

AFG

VHM-Schrupfräser

3 - 5 Schneiden, kurze Ausführung



Solid carbide roughing end-mill

3 - 5 flutes, short design

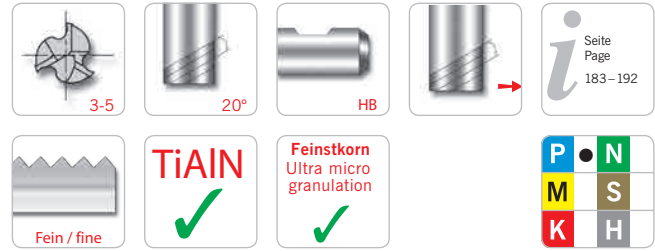

AFG606.0-...

Schaft / Shank DIN 6535HB	d h10	d _A h6	l ₁	l	z
AFG60630-060	6,0	6	7,0	54	3
AFG60630-080	8,0	8	9,0	58	3
AFG60640-100	10,0	10	14,0	66	4
AFG60640-120	12,0	12	16,0	73	4
AFG60640-140	14,0	14	18,0	75	4
AFG60640-160	16,0	16	22,0	82	4
AFG60640-180	18,0	18	24,0	84	4
AFG60640-200	20,0	20	26,0	92	4
AFG60650-250	25,0	25	25,0	110	5

Toleranz / Tolerance (μm)	Nennwertbereich / Diameter range (mm)		
	> 6 - 10	> 10 - 18	> 18 - 30
h10	0 -58	0 -70	0 -84
h6	0 -9	0 -11	0 -13

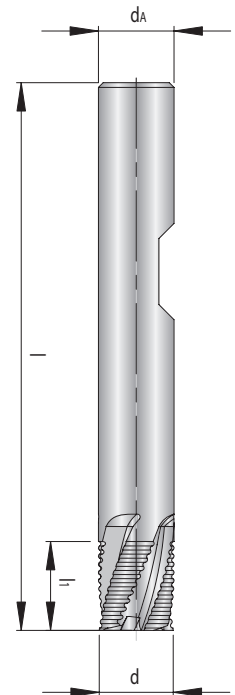

AFG

● = Hauptanwendung / Main application
○ = Nebenanwendung / Suitable

Alle Angaben in mm / Dimensions in mm

VHM-Schruppräser

3 - 5 Schneiden, lange Ausführung

Solid carbide roughing end-mill

3 - 5 flutes, long design



N NEU/NEW

Seite Page 183-192

P	●	N
M		S
K		H

AFG

AFG606.1-...

Schaft / Shank DIN 6535HB	d h10	d _A h6	l ₁	l	z
AFG60631-040 N	4,0	6	11,0	57	3
AFG60631-050 N	5,0	6	13,0	57	3
AFG60631-060	6,0	6	16,0	57	3
AFG60631-070 N	7,0	8	16,0	63	3
AFG60631-080	8,0	8	16,0	63	3
AFG60641-090	9,0	10	19,0	72	4
AFG60641-100	10,0	10	22,0	72	4
AFG60641-120	12,0	12	26,0	83	4
AFG60641-140	14,0	14	26,0	83	4
AFG60641-160	16,0	16	32,0	92	4
AFG60641-180	18,0	18	32,0	92	4
AFG60641-200	20,0	20	38,0	104	4
AFG60651-250	25,0	25	45,0	121	5

Toleranz / Tolerance (μm)	Nennwertbereich / Diameter range (mm)			
	> 3 - 6	> 6 - 10	> 10 - 18	> 18 - 30
h10	0 -48	0 -58	0 -70	0 -84
h6	0 -8	0 -9	0 -11	0 -13

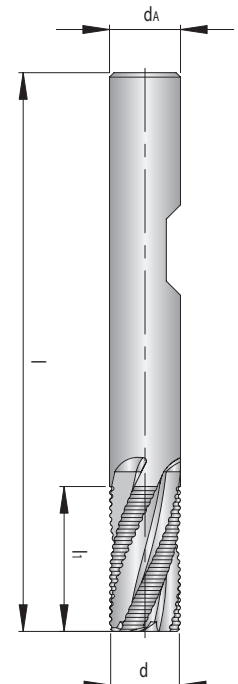

Empfohlene Schnittwerte VHM-Schafffräser

Ausführung AFG

ISO	Werkstoff	Festigkeit [N/mm ²]	Vorschub-Korrekturfaktor [$\times f_z$]	Schrupp- und Nutfräsen				Schlicht- und Konturfräsen				
				AlTiN <small>V_c [m/min]</small>	TiAlN <small>V_c [m/min]</small>	TiCN <small>V_c [m/min]</small>	Tia70 <small>V_c [m/min]</small>	AlTiN <small>V_c [m/min]</small>	TiAlN <small>V_c [m/min]</small>	TiCN <small>V_c [m/min]</small>	Tia70 <small>V_c [m/min]</small>	
P	Allgemeiner Baustahl	< 800	1,2		100-150				200-240			
	Automatenstahl	< 800	1,2		100-150				200-240			
	Einsatzstahl, unlegiert	< 800	1,2		100-150				200-240			
	Einsatzstahl, legiert	< 1000	1		90-120				170-200			
	Vergütungsstahl, unlegiert	< 850	1,2		90-130				180-220			
	Vergütungsstahl, unlegiert	< 1000	1		60-90				100-140			
	Vergütungsstahl, legiert	< 800	1,2		90-120				170-200			
	Vergütungsstahl, legiert	< 1300	0,8		60-80				90-120			
	Stahlguss	< 850	1,2		70-100				150-180			
	Nitrierstahl	< 1000	1		80-90				100-140			
	Nitrierstahl	< 1200	0,8		60-80				90-120			
	Wälzlagerstahl	< 1200	0,8		60-90				100-140			
	Federstahl	< 1200	0,8		40-60				90-120			
	Schnellarbeitsstahl	< 1300	0,8		40-50				40-50			
Werkzeugstahl für Kaltarbeit	< 1300	0,8		60-70				90-110				
Werkzeugstahl für Warmarbeit	< 1300	0,8		60-70				90-110				
M	Stahl und Stahlguss, rostfrei geschwefelt	< 850	1		60-80				85-120			
	Nichtrostender Stahl, ferritisch	< 750	1		50-70				85-120			
	Nichtrostender Stahl, martensitisch	< 900	1		40-60				70-100			
	Nichtrostender Stahl, ferritisch/martensitisch	< 1100	0,9		30-40				60-80			
	Nichtrostender Stahl, austenitisch/ferritisch	< 850	1		50-70				80-120			
	Nichtrostender Stahl, austenitisch	< 750	1		60-80				80-120			
Hitzebeständig	< 1100	0,9		30-40				60-80				
K	Grauguss mit Lammellengraphit	100-350										
	Grauguss mit Lammellengraphit	300-1000										
	Kugelgraphitguss	300-500										
	Kugelgraphitguss	550-800										
	Temperguss, weiß	350-450										
	Temperguss, weiß	500-650										
	Temperguss, schwarz	350-450										
	Temperguss, schwarz	500-700										
N	Aluminium (unlegiert, niedrig legiert)	< 350										
	Aluminiumlegierungen < 0,5% Si	< 500										
	Aluminiumlegierungen 0,5 - 10% Si	< 400										
	Aluminiumlegierungen 10 - 15% Si	< 400										
	Aluminiumlegierungen > 15% Si	< 400										
	Kupfer (unlegiert, niedrig legiert)	< 350										
	Kupfer-Knetlegierungen	< 700										
	Kupfer-Sonderlegierungen	< 200 HB										
	Kupfer-Sonderlegierungen	< 300 HB										
	Kupfer-Sonderlegierungen	> 300 HB										
	Messing kurzspanend, Bronze, Rotguss	< 600										
	Messing langspanend	< 600										
	Thermoplaste											
	Duroplaste											
	Faserverstärkte Kunststoffe											
	Magnesium und Magnesiumlegierungen	< 850										
Graphit												
Wolfram und Wolframlegierungen												
Molybdän und Molybdänlegierungen												
S	Reinnickel											
	Nickellegierungen											
	Nickellegierungen	< 850										
	Nickel-Chromlegierungen											
	Nickel- und Kobaltlegierungen	< 1300										
	Hochwärmefeste Legierungen	< 1300										
	Nickel-Kobalt-(Chrom-)legierungen	< 1400										
	Nickel- und Kobaltlegierungen	< 1300										
	Reintitan	< 900										
Titanlegierungen	< 700											
Titanlegierungen	< 1200											
H	Stahl gehärtet	< 45 HRC	0,7		45-60				120-150			
		46-55 HRC	0,7		20-45				80-120			
		56-60 HRC	1,1		12-20							
		61-65 HRC										
		65-70 HRC										

Die Tabellenwerte sind Richtwerte. Es kann notwendig sein, die Werte den jeweiligen Bearbeitungsbedingungen anzupassen.

AFG

Recommended cutting data Solid carbide end-mill

Design AFG

ISO	Material	Strength [N/mm ²]	Correction factor [x f _c]	Roughing and full slot milling				Peripheral- and contour milling				
				AlTiN	TiAlN	TiCN	Tia70	AlTiN	TiAlN	TiCN	Tia70	
				V _c [m/min]	V _c [m/min]	V _c [m/min]	V _c [m/min]	V _c [m/min]	V _c [m/min]	V _c [m/min]	V _c [m/min]	
P	General construction steel	< 800	1,2		100-150				200-240			
	Free cutting steel	< 800	1,2		100-150				200-240			
	Case hardened steel, non alloyed	< 800	1,2		100-150				200-240			
	Alloyed case hardened steel	< 1000	1		90-120				170-200			
	Tempering steel, non alloyed	< 850	1,2		90-130				180-220			
	Tempering steel, non alloyed	< 1000	1		60-90				100-140			
	Tempering steel, alloyed	< 800	1,2		90-120				170-200			
	Tempering steel, alloyed	< 1300	0,8		60-80				90-120			
	Steel castings	< 850	1,2		70-100				150-180			
	Nitriding steel	< 1000	1		80-90				100-140			
	Nitriding steel	< 1200	0,8		60-80				90-120			
	Roller bearing steel	< 1200	0,8		60-90				100-140			
	Spring steel	< 1200	0,8		40-60				90-120			
	High-speed steel	< 1300	0,8		40-50				40-50			
Cold working tool steel	< 1300	0,8		60-70				90-110				
Hot working tool steel	< 1300	0,8		60-70				90-110				
M	Steel and sulphured cast stainless steel	< 850	1		60-80				85-120			
	Stainless steel, ferritic	< 750	1		50-70				85-120			
	Stainless steel, martensitic	< 900	1		40-60				70-100			
	Stainless steel, ferritic/martensitic	< 1100	0,9		30-40				60-80			
	Stainless steel, austenitic/ferritic	< 850	1		50-70				80-120			
	Stainless steel, austenitic	< 750	1		60-80				80-120			
	Heat resistant steel	< 1100	0,9		30-40				60-80			
K	Grey cast iron with lamellar graphite	100-350										
	Grey cast iron with lamellar graphite	300-1000										
	Spheroidal cast iron	300-500										
	Spheroidal cast iron	550-800										
	White cast iron, tempered	350-450										
	White cast iron, tempered	500-650										
	Black cast iron, tempered	350-450										
	Black cast iron, tempered	500-700										
N	Aluminium (non alloyed, low alloyed)	< 350										
	Aluminium alloys < 0,5% Si	< 500										
	Aluminium alloys 0,5% - 10% Si	< 400										
	Aluminium alloys 10% - 15% Si	< 400										
	Aluminium alloys > 15% Si	< 400										
	Copper (non alloyed, low alloyed)	< 350										
	Copper wrought alloys	< 700										
	Special copper alloys	< 200 HB										
	Special copper alloys	< 300 HB										
	Special copper alloys	> 300 HB										
	Short-chipping brass, bronze, red bronze	< 600										
	Long-chipping brass	< 600										
	Thermoplastics											
	Duroplastics											
	Fibre-reinforced plastics											
	Magnesium and magnesium alloys	< 850										
	Graphite											
Tungsten and tungsten alloys												
Molybdenum and molybdenum alloys												
S	Pure nickel											
	Nickel alloys											
	Nickel alloys	< 850										
	Nickel-chromium alloys											
	Nickel and cobalt alloys	< 1300										
	Nickel and cobalt alloys	< 1300										
	Heat resistant alloys	< 1400										
	Nickel-cobalt-chromium alloys	< 1300										
	Pure titanium	< 900										
	Titanium alloys	< 700										
Titanium alloys	< 1200											
H	Tempered steel	< 45 HRC	0,7		45-60				120-150			
		46-55 HRC	0,7		20-45				80-120			
		56-60 HRC	1,1		12-20							
		61-65 HRC										
		65-70 HRC										

The recommended cutting data are only approximate values. It may be necessary to adjust them to each individual machining application.

Für die nachfolgenden Vorschub-Richtwerte müssen die Werte je nach zu bearbeitendem Material gemäß dem in den Schnittgeschwindigkeitstabellen angegebenen Korrekturfaktor $K_f [f_z]$ korrigiert werden.

For the following feed tables the values must be corrected depending on the material being machined in line with the correction factor $K_f [f_z]$.

Beispiel für Fräser mit Schneidendurchmesser 6 mm:

An example using a cutter with \varnothing 6 mm is detailed:

Schnittgeschwindigkeits-Tabelle / V_c -table

ISO	Werkstoff / Material	Festigkeit Strength [N/mm ² - HB]	$K_f [x f_z]$	TiAlN V_c [m/min]
P	Allgemeiner Baustahl General construction steel	< 800 N/mm ²	1,2	100 - 150
	Automatenstahl Free cutting steel	< 800 N/mm ²	1,2	100 - 150
	Einsatzstahl, unlegiert Case hardened steel, non alloyed	< 800 N/mm ²	1,2	100 - 150
	Einsatzstahl, legiert Alloyed case hardened steel	< 1000 N/mm ²	1	90 - 120
	Vergütungsstahl, unlegiert Tempering steel, non alloyed	< 850 N/mm ²	1,2	90 - 130
	Vergütungsstahl, unlegiert Tempering steel, non alloyed	< 1000 N/mm ²	1	60 - 90
	Vergütungsstahl, legiert Tempering steel, alloyed	< 800 N/mm ²	1,2	90 - 120
	Vergütungsstahl, legiert Tempering steel, alloyed	< 1300 N/mm ²	0,8	60 - 80
	Stahlguss Steel castings	< 850 N/mm ²	1,2	70 - 100

Korrekturfaktor-Tabelle / f_z -table

$\varnothing d_1$ [mm]	Korrekturfaktor/ Correction factor $K_f [f_z]$		
	1	0,7	0,8
1	0,004	0,003	0,003
2	0,008	0,006	0,006
3	0,012	0,008	0,010
4	0,016	0,011	0,013
5	0,020	0,014	0,016
6	0,024	0,017	0,019
8	0,032	0,022	0,026

Für legierten Einsatzstahl gilt der Vorschubwert aus der Korrekturfaktor-Tabelle.

$K_f (f_z) = 1$ (entsprechend 100%) $f_z = 0,024$

Für legierten Vergütungsstahl < 1300 N/mm² wird der Vorschubwert aus der Korrekturfaktor-Tabelle um 20% reduziert.

$K_f (f_z) = 0,8$ (entsprechend 80%) $f_z = 0,019$

For case-hardening alloy steel the feed value from the table is valid:

$K_f (f_z) = 1$ (according to 100%) $f_z = 0,024$

For heat treatable steel alloys < 1300 N/mm² the feed value from the table is reduced by 20%.

$K_f (f_z) = 0,8$ (according to 80%) $f_z = 0,019$

Generelle Berechnungsformeln / General rule:

Vorschub pro Zahn / Feed per tooth: $= f_z \cdot K_f (f_z)$

Bohrvorschub (Fräsen in axialer Richtung): = Tabellenwert / Zähnezahl

For axial plunge milling: = Table value / Number of teeth

Vorschub pro Zahn bei einer radialen Zustellung von 0,2 – 0,3 mm

Feed per tooth with radial depth of cut from 0,2 – 0,3 mm

≤ 40 HRC

Ø d ₁ [mm]	Korrekturfaktor / Correction factor Kf [f _z]									
	1	0,7	0,8	0,9	1,1	1,2	1,5	1,6	1,8	1,9
1	0,004	0,003	0,003	0,004	0,004	0,005	0,006	0,006	0,007	0,008
2	0,008	0,006	0,006	0,007	0,009	0,010	0,012	0,013	0,014	0,015
3	0,012	0,008	0,010	0,011	0,013	0,014	0,018	0,019	0,022	0,023
4	0,016	0,011	0,013	0,014	0,018	0,019	0,024	0,026	0,029	0,030
5	0,020	0,014	0,016	0,018	0,022	0,024	0,030	0,032	0,036	0,038
6	0,024	0,017	0,019	0,022	0,026	0,029	0,036	0,038	0,043	0,046
8	0,032	0,022	0,026	0,029	0,035	0,038	0,048	0,051	0,058	0,061
10	0,040	0,028	0,032	0,036	0,044	0,048	0,060	0,064	0,072	0,076
12	0,048	0,034	0,038	0,043	0,053	0,058	0,072	0,077	0,086	0,091
14	0,056	0,039	0,045	0,050	0,062	0,067	0,084	0,090	0,101	0,106
16	0,064	0,045	0,051	0,058	0,070	0,077	0,096	0,102	0,115	0,122
18	0,072	0,050	0,058	0,065	0,079	0,086	0,108	0,115	0,130	0,137
20	0,080	0,056	0,064	0,072	0,088	0,096	0,120	0,128	0,144	0,152
22	0,090	0,060	0,070	0,080	0,095	0,110	0,130	0,140	0,160	0,170
25	0,100	0,070	0,080	0,090	0,110	0,120	0,150	0,160	0,180	0,190

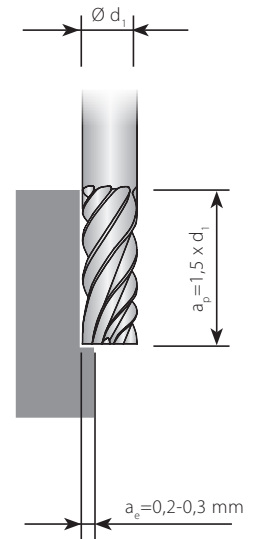

AFG

Vorschub pro Zahn bei einer radialen Zustellung 10% vom Schneidendurchmesser (Ø d₁)

Feed per tooth with radial depth of cut of 10 % of the cutter (Ø d₁)

≤ 40 HRC

Ø d ₁ [mm]	Korrekturfaktor / Correction factor Kf [f _z]									
	1	0,7	0,8	0,9	1,1	1,2	1,5	1,6	1,8	1,9
1	0,003	0,002	0,002	0,003	0,003	0,004	0,005	0,005	0,005	0,006
2	0,008	0,006	0,006	0,007	0,009	0,010	0,012	0,013	0,014	0,015
3	0,012	0,008	0,010	0,011	0,013	0,014	0,018	0,019	0,022	0,023
4	0,014	0,010	0,011	0,013	0,015	0,017	0,021	0,022	0,025	0,027
5	0,017	0,012	0,014	0,015	0,019	0,020	0,026	0,027	0,031	0,032
6	0,020	0,014	0,016	0,018	0,022	0,024	0,030	0,032	0,036	0,038
8	0,027	0,019	0,022	0,024	0,030	0,032	0,041	0,043	0,049	0,051
10	0,033	0,023	0,026	0,030	0,036	0,040	0,050	0,053	0,059	0,063
12	0,040	0,028	0,032	0,036	0,044	0,048	0,060	0,064	0,072	0,076
14	0,047	0,033	0,038	0,042	0,052	0,056	0,071	0,075	0,085	0,089
16	0,053	0,037	0,042	0,048	0,058	0,064	0,080	0,085	0,095	0,101
18	0,060	0,042	0,048	0,054	0,066	0,072	0,090	0,096	0,108	0,114
20	0,067	0,047	0,054	0,060	0,074	0,080	0,101	0,107	0,121	0,127
25	0,083	0,058	0,066	0,075	0,091	0,100	0,125	0,133	0,149	0,158

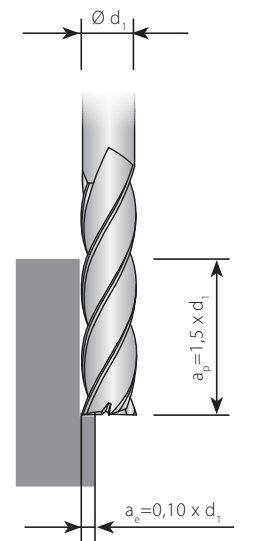

Achtung:
Vorschub-Korrekturfaktor → Kf f_z = 1,10 bei a_p = 1 x d₁ und → Kf f_z = 1,25 bei a_p = 0,5 x d₁
Für unbeschichtete Werkzeuge ist der Vorschub um 10-20 % zu reduzieren.

Attention:
Feed rate correction factor → Kf f_z = 1,10 with a_p = 1 x d₁ and → Kf f_z = 1,25 with a_p = 0,5 x d₁
Feed rates are reduced by 10-20 % for uncoated tools.

Vorschub pro Zahn bei einer radialen Zustellung 20% vom Schneidendurchmesser ($\varnothing d_1$) ≤ 40 HRC
 Feed per tooth with radial depth of cut of 20% of the cutter ($\varnothing d_1$)

$\varnothing d_1$ [mm]	Korrekturfaktor / Correction factor $K_f [f_z]$									
	1	0,7	0,8	0,9	1,1	1,2	1,5	1,6	1,8	1,9
1	0,002	0,001	0,001	0,001	0,002	0,002	0,003	0,003	0,003	0,003
2	0,005	0,003	0,004	0,004	0,005	0,006	0,007	0,008	0,009	0,009
3	0,008	0,005	0,006	0,007	0,008	0,009	0,012	0,012	0,014	0,015
4	0,010	0,007	0,008	0,009	0,011	0,012	0,015	0,016	0,018	0,019
5	0,013	0,009	0,010	0,011	0,014	0,015	0,019	0,020	0,023	0,024
6	0,015	0,010	0,012	0,013	0,016	0,018	0,022	0,024	0,027	0,028
8	0,020	0,014	0,016	0,018	0,022	0,024	0,030	0,032	0,036	0,038
10	0,025	0,017	0,020	0,022	0,027	0,030	0,037	0,040	0,045	0,047
12	0,030	0,021	0,024	0,027	0,033	0,036	0,045	0,048	0,054	0,057
14	0,035	0,024	0,028	0,031	0,038	0,042	0,052	0,056	0,063	0,066
16	0,040	0,028	0,032	0,036	0,044	0,048	0,060	0,064	0,072	0,076
18	0,045	0,031	0,036	0,040	0,049	0,054	0,067	0,072	0,081	0,085
20	0,050	0,035	0,040	0,045	0,055	0,060	0,075	0,080	0,090	0,095
22	0,055	0,040	0,045	0,050	0,060	0,065	0,080	0,090	0,100	0,100
25	0,063	0,044	0,050	0,056	0,069	0,075	0,094	0,100	0,113	0,119

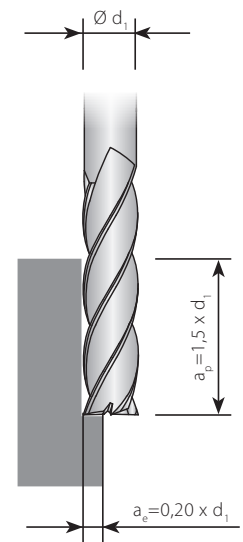

Vorschub pro Zahn bei einer radialen Zustellung 40% vom Schneidendurchmesser ($\varnothing d_1$) ≤ 40 HRC
 Feed per tooth with radial depth of cut of 40% of the cutter ($\varnothing d_1$)

$\varnothing d_1$ [mm]	Korrekturfaktor / Correction factor $K_f [f_z]$									
	1	0,7	0,8	0,9	1,1	1,2	1,5	1,6	1,8	1,9
1	0,001	0,001	0,001	0,001	0,001	0,001	0,002	0,002	0,002	0,003
2	0,004	0,002	0,003	0,003	0,004	0,004	0,006	0,006	0,007	0,007
3	0,006	0,004	0,005	0,005	0,007	0,007	0,009	0,010	0,011	0,012
4	0,008	0,005	0,006	0,007	0,008	0,009	0,012	0,012	0,014	0,015
5	0,010	0,007	0,008	0,009	0,011	0,012	0,015	0,016	0,018	0,019
6	0,012	0,008	0,009	0,010	0,013	0,014	0,018	0,019	0,021	0,022
8	0,016	0,011	0,012	0,014	0,017	0,019	0,024	0,025	0,028	0,030
10	0,020	0,014	0,016	0,018	0,022	0,024	0,030	0,032	0,036	0,038
12	0,024	0,016	0,019	0,021	0,026	0,028	0,036	0,038	0,043	0,045
14	0,028	0,019	0,022	0,025	0,030	0,033	0,042	0,044	0,050	0,053
16	0,032	0,022	0,025	0,028	0,035	0,038	0,048	0,051	0,057	0,060
18	0,036	0,025	0,028	0,032	0,039	0,043	0,054	0,057	0,064	0,068
20	0,040	0,028	0,032	0,036	0,044	0,048	0,060	0,064	0,072	0,076
22	0,045	0,030	0,035	0,040	0,045	0,050	0,065	0,070	0,080	0,085
25	0,050	0,035	0,040	0,045	0,055	0,060	0,075	0,080	0,090	0,095

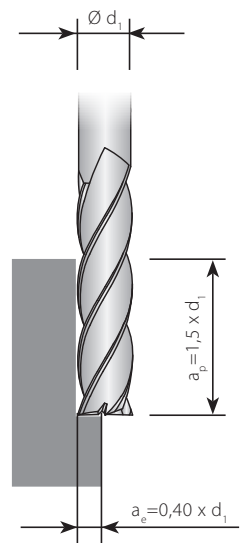

Achtung:
 Vorschub-Korrekturfaktor $\rightarrow K_f f_z = 1,10$ bei $a_p = 1 \times d_1$ und $\rightarrow K_f f_z = 1,25$ bei $a_p = 0,5 \times d_1$
 Für unbeschichtete Werkzeuge ist der Vorschub um 10-20% zu reduzieren.

Attention:
 Feed rate correction factor $\rightarrow K_f f_z = 1,10$ with $a_p = 1 \times d_1$ and $\rightarrow K_f f_z = 1,25$ with $a_p = 0,5 \times d_1$
 Feed rates are reduced by 10-20% for uncoated tools.

Vorschub pro Zahn bei einer radialen Zustellung 60% vom Schneidendurchmesser ($\varnothing d_1$) ≤ 40 HRC
 Feed per tooth with radial depth of cut of 60% of the cutter ($\varnothing d_1$)

$\varnothing d_1$ [mm]	Korrekturfaktor / Correction factor Kf [f _z]									
	1	0,7	0,8	0,9	1,1	1,2	1,5	1,6	1,8	1,9
1	0,001	0,001	0,001	0,001	0,001	0,001	0,001	0,002	0,002	0,002
2	0,003	0,002	0,002	0,002	0,003	0,003	0,004	0,005	0,005	0,006
3	0,005	0,003	0,004	0,004	0,005	0,006	0,007	0,008	0,009	0,009
4	0,006	0,004	0,005	0,005	0,007	0,007	0,009	0,010	0,011	0,012
5	0,008	0,005	0,006	0,007	0,009	0,010	0,012	0,013	0,015	0,016
6	0,009	0,006	0,007	0,008	0,010	0,011	0,014	0,015	0,017	0,018
8	0,013	0,009	0,010	0,011	0,014	0,015	0,019	0,020	0,023	0,024
10	0,016	0,011	0,013	0,014	0,017	0,019	0,024	0,026	0,029	0,030
12	0,019	0,013	0,015	0,017	0,021	0,023	0,029	0,031	0,035	0,037
14	0,022	0,015	0,018	0,020	0,025	0,027	0,034	0,036	0,040	0,043
16	0,026	0,018	0,020	0,023	0,028	0,031	0,039	0,041	0,046	0,049
18	0,029	0,020	0,023	0,026	0,032	0,035	0,043	0,046	0,052	0,055
20	0,032	0,022	0,026	0,029	0,035	0,039	0,048	0,052	0,058	0,061
22	0,035	0,025	0,030	0,031	0,038	0,041	0,053	0,054	0,064	0,066
25	0,040	0,028	0,032	0,036	0,045	0,049	0,061	0,065	0,073	0,077

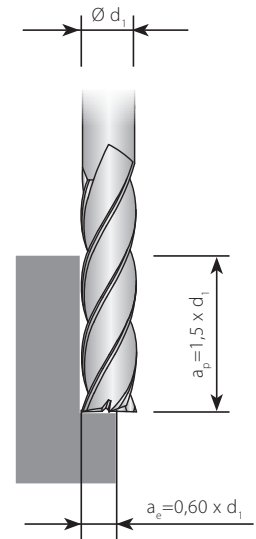

AFG

Vorschub pro Zahn bei einer radialen Zustellung 80% vom Schneidendurchmesser ($\varnothing d_1$) ≤ 40 HRC
 Feed per tooth with radial depth of cut of 80% of the cutter ($\varnothing d_1$)

$\varnothing d_1$ [mm]	Korrekturfaktor / Correction factor Kf [f _z]									
	1	0,7	0,8	0,9	1,1	1,2	1,5	1,6	1,8	1,9
1	0,001	0,001	0,001	0,001	0,001	0,001	0,001	0,001	0,001	0,001
2	0,002	0,001	0,002	0,002	0,002	0,003	0,003	0,004	0,004	0,004
3	0,004	0,002	0,003	0,003	0,004	0,004	0,006	0,006	0,007	0,007
4	0,005	0,003	0,004	0,004	0,005	0,006	0,007	0,008	0,009	0,009
5	0,006	0,004	0,005	0,005	0,007	0,007	0,009	0,010	0,011	0,012
6	0,007	0,005	0,006	0,006	0,008	0,009	0,011	0,012	0,013	0,014
8	0,010	0,007	0,008	0,009	0,011	0,012	0,015	0,016	0,018	0,019
10	0,012	0,008	0,010	0,011	0,013	0,015	0,018	0,020	0,022	0,023
12	0,015	0,010	0,012	0,013	0,016	0,018	0,022	0,024	0,027	0,028
14	0,017	0,012	0,014	0,015	0,019	0,021	0,026	0,028	0,031	0,033
16	0,020	0,014	0,016	0,018	0,022	0,024	0,030	0,032	0,036	0,038
18	0,022	0,015	0,018	0,020	0,024	0,027	0,033	0,036	0,040	0,042
20	0,025	0,017	0,020	0,022	0,027	0,030	0,037	0,040	0,045	0,047
22	0,030	0,020	0,020	0,024	0,030	0,031	0,040	0,045	0,050	0,050
25	0,031	0,022	0,025	0,028	0,034	0,037	0,047	0,050	0,056	0,059

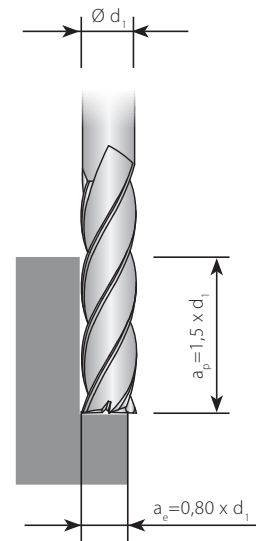

Achtung:
 Vorschub-Korrekturfaktor $\rightarrow Kf f_z = 1,10$ bei $a_p = 1 \times d_1$ und $\rightarrow Kf f_z = 1,25$ bei $a_p = 0,5 \times d_1$
 Für unbeschichtete Werkzeuge ist der Vorschub um 10-20% zu reduzieren.

Attention:
 Feed rate correction factor $\rightarrow Kf f_z = 1,10$ with $a_p = 1 \times d_1$ and $\rightarrow Kf f_z = 1,25$ with $a_p = 0,5 \times d_1$
 Feed rates are reduced by 10-20% for uncoated tools.

Vorschub pro Zahn beim Vollnutfräsen → $a_p = 0,5 \times d_1$
 Feed per tooth when full slot milling → $a_p = 0,5 \times d_1$

≤ 40 HRC

Ø d ₁ [mm]	Korrekturfaktor / Correction factor Kf [f ₁]									
	1	0,7	0,8	0,9	1,1	1,2	1,5	1,6	1,8	1,9
1	0,002	0,001	0,001	0,001	0,002	0,002	0,003	0,003	0,003	0,003
2	0,004	0,002	0,003	0,003	0,004	0,004	0,006	0,006	0,007	0,007
3	0,007	0,004	0,005	0,006	0,007	0,008	0,010	0,011	0,012	0,013
4	0,009	0,006	0,007	0,008	0,009	0,010	0,013	0,014	0,016	0,017
5	0,011	0,007	0,008	0,009	0,012	0,013	0,016	0,017	0,019	0,020
6	0,013	0,009	0,010	0,011	0,014	0,015	0,019	0,020	0,023	0,024
8	0,018	0,012	0,014	0,016	0,019	0,021	0,027	0,028	0,032	0,034
10	0,022	0,015	0,017	0,019	0,024	0,026	0,033	0,035	0,039	0,041
12	0,030	0,021	0,024	0,027	0,033	0,036	0,045	0,048	0,054	0,057
14	0,032	0,022	0,025	0,028	0,035	0,038	0,048	0,051	0,057	0,060
16	0,036	0,025	0,028	0,032	0,039	0,043	0,054	0,057	0,064	0,068
18	0,042	0,029	0,033	0,037	0,046	0,050	0,063	0,067	0,075	0,079
20	0,045	0,031	0,036	0,040	0,049	0,054	0,067	0,072	0,081	0,085
22	0,050	0,035	0,040	0,045	0,055	0,060	0,072	0,076	0,090	0,095
25	0,056	0,039	0,044	0,050	0,061	0,067	0,084	0,089	0,100	0,106

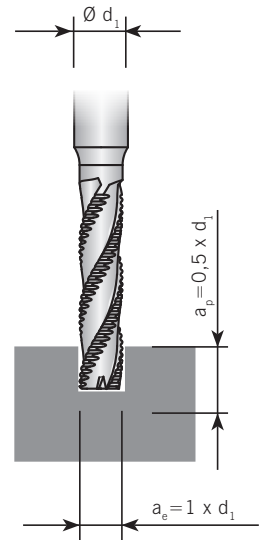

AFG

Vorschub pro Zahn beim Vollnutfräsen → $a_p = 1 \times d_1$
 Feed per tooth when full slot milling → $a_p = 1 \times d_1$

≤ 40 HRC

Ø d ₁ [mm]	Korrekturfaktor / Correction factor Kf [f ₁]									
	1	0,7	0,8	0,9	1,1	1,2	1,5	1,6	1,8	1,9
1	0,001	0,001	0,001	0,001	0,001	0,002	0,002	0,002	0,002	0,002
2	0,003	0,002	0,002	0,002	0,003	0,003	0,004	0,004	0,005	0,005
3	0,005	0,003	0,004	0,004	0,005	0,005	0,007	0,007	0,008	0,009
4	0,006	0,004	0,005	0,005	0,006	0,007	0,009	0,009	0,011	0,011
5	0,007	0,005	0,006	0,006	0,008	0,009	0,011	0,011	0,013	0,014
6	0,008	0,006	0,007	0,008	0,009	0,010	0,013	0,014	0,015	0,016
8	0,012	0,008	0,009	0,011	0,013	0,014	0,018	0,019	0,021	0,022
10	0,014	0,010	0,011	0,013	0,016	0,017	0,021	0,023	0,026	0,027
12	0,020	0,014	0,016	0,018	0,021	0,023	0,029	0,031	0,035	0,037
14	0,021	0,015	0,017	0,019	0,023	0,025	0,031	0,033	0,037	0,040
16	0,023	0,016	0,019	0,021	0,026	0,028	0,035	0,037	0,042	0,044
18	0,027	0,019	0,022	0,025	0,030	0,033	0,041	0,044	0,049	0,052
20	0,029	0,020	0,023	0,026	0,032	0,035	0,044	0,047	0,053	0,056
22	0,031	0,022	0,025	0,030	0,038	0,040	0,050	0,050	0,060	0,061
25	0,036	0,025	0,029	0,033	0,040	0,044	0,055	0,058	0,066	0,069

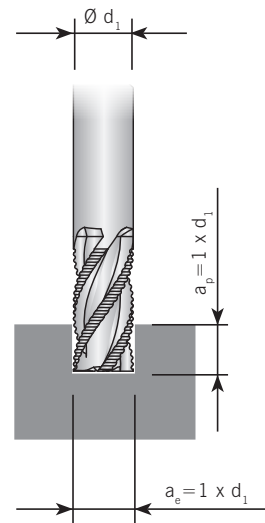

Achtung:
 Für unbeschichtete Werkzeuge ist der Vorschub um 10-20% zu reduzieren.

Attention:
 Feed rates are reduced by 10-20% for uncoated tools.

Alle Angaben in mm / Dimensions in mm

Vorschübe für Vollradius- und Torusfräser
Feed rates for ball nosed- and High feed cutters

≤ 40 HRC

AFG

Radiusfräser Ball nose end milling cutters		Radiusfräser Ball nose end milling cutters		Formenbau- Radiusfräser Ball nose cutter for mold and die production		Torusfräser High feed cutters		Torusfräser High feed cutters	
TiAlN-beschichtet TiAlN-coated		TiAlN-beschichtet TiAlN-coated		TiAlN-beschichtet TiAlN-coated		TiAlN-beschichtet TiAlN-coated		TiAlN-beschichtet TiAlN-coated	
d ₁ [mm]	fz [mm]	fz [mm]	fz [mm]	fz [mm]	fz [mm]	fz [mm]	fz [mm]	fz [mm]	fz [mm]
2	0,015	0,010	0,005	0,010	0,015				
3	0,030	0,020	0,015	0,015	0,020				
4	0,040	0,030	0,030	0,020	0,030				
5	0,060	0,050	0,050	0,030	0,040				
6	0,070	0,060	0,060	0,050	0,060				
8	0,100	0,080	0,070	0,070	0,080				
10	0,120	0,100	0,080	0,080	0,100				
12	0,150	0,120	0,090	0,100	0,120				
14	0,160	0,140	0,090	0,110	0,130				
16	0,180	0,150	0,100	0,120	0,150				
18	0,200	0,180	0,110	0,140	0,160				
20	0,220	0,200	0,120	0,150	0,180				
25	0,240	0,220	0,140	0,170	0,200				

Achtung:
Für unbeschichtete Werkzeuge ist der Vorschub um 10-20% zu reduzieren.

Attention:
Feed rates are reduced by 10-20% for uncoated tools.

Alle Angaben in mm / Dimensions in mm

Vorschub pro Zahn f_z [mm], gehärtete Stähle, Trockenbearbeitung
 Feed per tooth f_z [mm], hardened materials, dry processing

≤ 40 HRC

VHM-Schaftfräser Solid carbide end-mill		VHM-Schaftfräser Solid carbide end-mill		VHM-Schaftfräser Solid carbide end-mill		VHM-Schaftfräser Solid carbide end-mill		VHM-Schaftfräser Solid carbide end-mill	
Härte/Hardness = 40 - 56 HRC Vc = 80 - 120 m/min		Härte/Hardness = 40 - 56 HRC Vc = 80 - 120 m/min		Härte/Hardness = 40 - 56 HRC Vc = 20 - 50 m/min		Härte/Hardness = 52 - 66 HRC Vc = 80 - 120 m/min		Härte/Hardness = 52 - 60 HRC Vc = 12 - 20 m/min	
TiAlN-beschichtet TiAlN-coated		TiAlN-beschichtet TiAlN-coated		TiAlN-beschichtet TiAlN-coated		TiAlN-beschichtet TiAlN-coated		TiAlN-beschichtet TiAlN-coated	
d_1 [mm]	f_z [mm]	f_z [mm]	f_z [mm]	f_z [mm]	f_z [mm]	f_z [mm]	f_z [mm]	f_z [mm]	f_z [mm]
2	0,005	0,005	0,004	0,005	0,002				
3	0,008	0,008	0,006	0,008	0,003				
4	0,015	0,013	0,009	0,010	0,004				
5	0,020	0,017	0,011	0,013	0,006				
6	0,026	0,021	0,015	0,015	0,008				
8	0,035	0,029	0,020	0,020	0,010				
10	0,043	0,036	0,025	0,025	0,013				
12	0,052	0,043	0,030	0,030	0,015				
14	0,060	0,050	0,035	0,035	0,018				
16	0,060	0,057	0,040	0,040	0,020				
18	0,060	0,060	0,045	0,045	0,023				
20	0,060	0,060	0,050	0,050	0,025				
22	0,060	0,060	0,050	0,050	0,030				
25	0,060	0,065	0,055	0,055	0,035				

AFG

Achtung:
Optimale Ergebnisse werden im Gleichlaufräsen erzielt.

Attention:
For optimal results it is recommended to climb mill.

Alle Angaben in mm / Dimensions in mm

Vorschub pro Zahn f_z [mm], gehärtete Stähle, Trockenbearbeitung
 Feed per tooth f_z [mm], hardened materials, dry processing

≤ 40 HRC

AFG

Radiusfräser Ball nose end milling cutters		Radiusfräser Ball nose end milling cutters		Formenbau-Radiusfräser Ball nose cutter for mold and die production		Formenbau-Radiusfräser Ball nose cutter for mold and die production		Torusfräser High feed cutters		Torusfräser High feed cutters	
Härte/Hardness = 40-63 HRC Vc = 80-120 m/min		Härte/Hardness = 40-60 HRC Vc = 80-120 m/min		Härte/Hardness = 40-56 HRC Vc = 80-120 m/min		Härte/Hardness = 40-60 HRC Vc = 80-120 m/min		Härte/Hardness = 40-60 HRC Vc = 80-120 m/min		Härte/Hardness = 40-60 HRC Vc = 80-120 m/min	
TiAlN-beschichtet TiAlN-coated		TiAlN-beschichtet TiAlN-coated		TiAlN-beschichtet TiAlN-coated		TiAlN-beschichtet TiAlN-coated		TiAlN-beschichtet TiAlN-coated		TiAlN-beschichtet TiAlN-coated	
d_1 [mm]	f_z [mm]	f_z [mm]	f_z [mm]	f_z [mm]	f_z [mm]	f_z [mm]	f_z [mm]	f_z [mm]	f_z [mm]	f_z [mm]	f_z [mm]
2	0,005	0,005	0,005	0,005	0,005	0,005	0,005	0,005	0,005	0,005	0,005
3	0,015	0,010	0,015	0,010	0,015	0,010	0,015	0,015	0,010	0,015	0,010
4	0,030	0,015	0,030	0,015	0,030	0,015	0,030	0,030	0,015	0,030	0,015
5	0,050	0,020	0,050	0,020	0,050	0,020	0,050	0,050	0,020	0,050	0,020
6	0,060	0,030	0,060	0,030	0,060	0,030	0,060	0,060	0,030	0,060	0,030
8	0,070	0,035	0,070	0,035	0,070	0,035	0,070	0,070	0,035	0,070	0,035
10	0,080	0,040	0,080	0,040	0,080	0,040	0,080	0,080	0,040	0,080	0,040
12	0,080	0,050	0,080	0,050	0,080	0,050	0,080	0,080	0,050	0,080	0,050
14	0,090	0,065	0,090	0,100	0,065	0,090	0,100	0,090	0,065	0,090	0,065
16	0,100	0,080	0,100	0,100	0,080	0,100	0,100	0,100	0,080	0,100	0,080
18	0,100	0,100	0,100	0,110	0,100	0,100	0,110	0,110	0,100	0,110	0,100
20	0,120	0,120	0,120	0,130	0,120	0,120	0,130	0,120	0,120	0,130	0,120
25	0,120	0,120	0,120	0,130	0,120	0,120	0,130	0,120	0,120	0,130	0,120

Achtung:
Optimale Ergebnisse werden im Gleichlaufräsen erzielt.

Attention:
For optimal results it is recommended to climb mill.

Alle Angaben in mm / Dimensions in mm

ARNO[®]

WERKZEUGE

We have a passion for precision.

AUSFÜHRUNG AFR

Design AFR

Schruppfräsung ganz nach Ihrem Bedarf.

Roughing to your requirements.

Die AFR Schruppfräser - mit ungleicher Drallsteigung von 43°– 46° - sind für die Bearbeitung legierter und unlegierter Stähle und Werkzeugstähle, sowie Gusseisen und gehärteten Werkstoffen bis 40 HRC optimal geeignet.



The cutter design with uneven pitch, 43°-46°, is suitable for milling alloy steel, non-alloy steel, cast iron and hardened materials up to 40HRC.

VHM-Schrupfräser

4-5 Schneiden, kurze Ausführung

Solid carbide roughing end-mill

4-5 flutes, short design

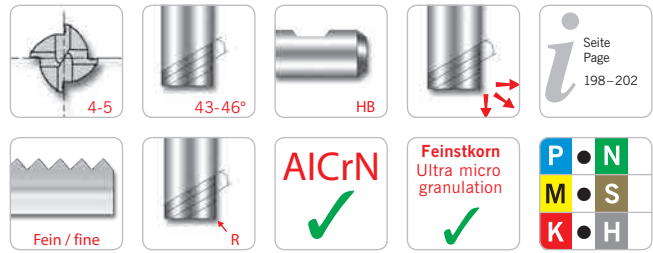

AFR619.0-...

AFR

Schaft / Shank DIN 6535HB	d	d _A	l ₁	l	R	z
AFR61940-060	6,0	6	9	57	0,50	4
AFR61940-080	8,0	8	12	63	0,50	4
AFR61940-100	10,0	10	15	72	0,50	4
AFR61940-120	12,0	12	18	83	0,50	4
AFR61950-160	16,0	16	24	92	1,00	5
AFR61950-200	20,0	20	30	104	1,00	5

Toleranz / Tolerance	
Fräser / Mill	0 -0,05
Schaft / Shank	h6

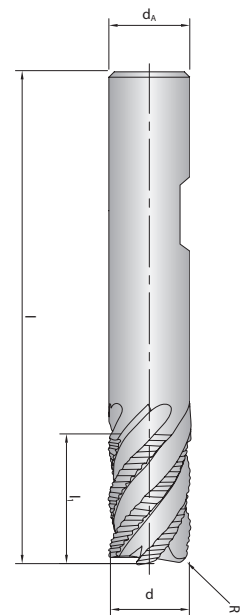

● = Hauptanwendung / Main application
○ = Nebenanwendung / Suitable

Alle Angaben in mm / Dimensions in mm

VHM-Schruppfräser

4-5 Schneiden, extra lange Ausführung

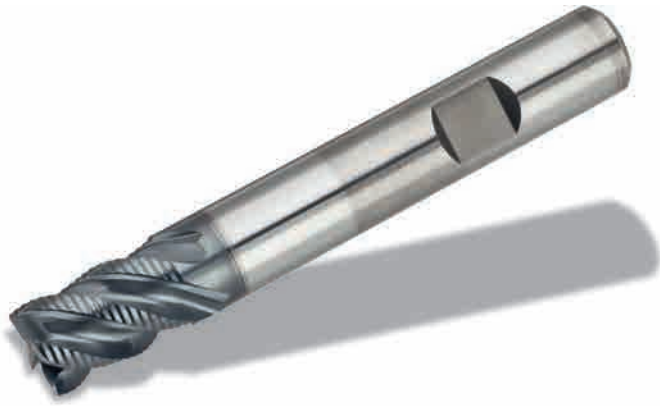

Solid carbide roughing end-mill

4-5 flutes, extra long design

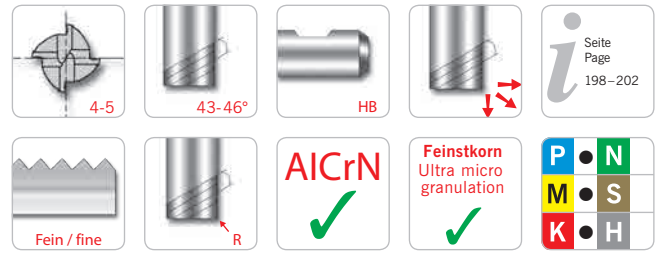

AFR619.1-...

Schaft / Shank DIN 6535HB	d	d _A	l ₁	l ₂	l	R	z
AFR61941-060	6,0	6	9	18	57	0,50	4
AFR61941-080	8,0	8	12	24	63	0,50	4
AFR61941-100	10,0	10	15	30	72	0,50	4
AFR61941-120	12,0	12	18	36	83	0,50	4
AFR61951-160	16,0	16	24	48	100	1,00	5
AFR61951-200	20,0	20	30	60	110	1,00	5

Toleranz / Tolerance	
Fräser / Mill	0 -0,05
Schaft / Shank	h6

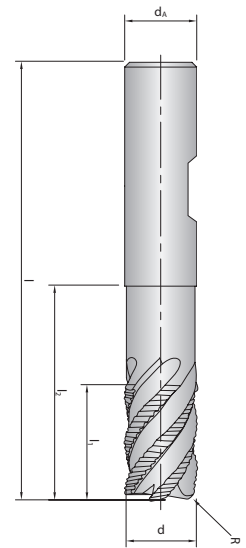

AFR

● = Hauptanwendung / Main application
○ = Nebenanwendung / Suitable

Alle Angaben in mm / Dimensions in mm

VHM-Schrupfräser

4-5 Schneiden, lange Ausführung

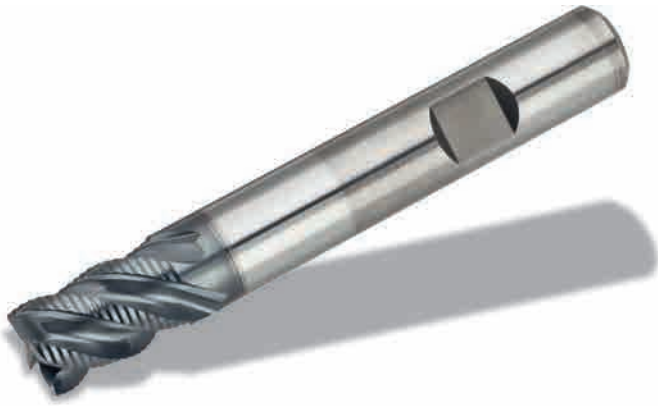

Solid carbide roughing end-mill

4-5 flutes, long design

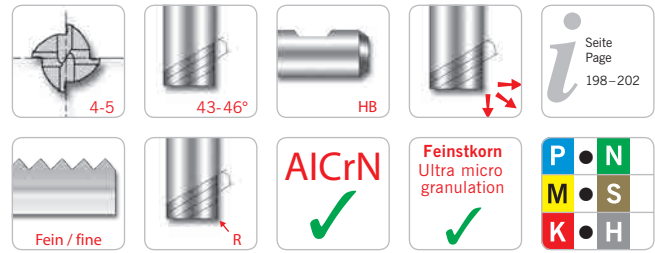

AFR619.2-...

AFR

Schaft / Shank DIN 6535HB	d	d _A	l ₁	l	R	z
AFR61942-060	6,0	6	12	57	0,50	4
AFR61942-080	8,0	8	16	63	0,50	4
AFR61942-100	10,0	10	20	72	0,50	4
AFR61942-120	12,0	12	24	83	0,50	4
AFR61952-160	16,0	16	32	92	1,00	5
AFR61952-200	20,0	20	40	104	1,00	5

Toleranz / Tolerance	
Fräser / Mill	0 -0,05
Schaft / Shank	h6

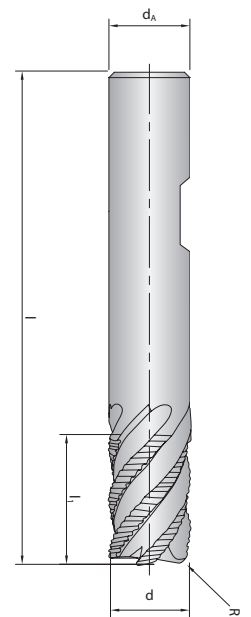

● = Hauptanwendung / Main application
○ = Nebenanwendung / Suitable

Alle Angaben in mm / Dimensions in mm

PM-HSS-Schrupfräser

4-5 Schneiden, lange Ausführung

PM-HSS roughing end-mill

4-5 flutes, long design

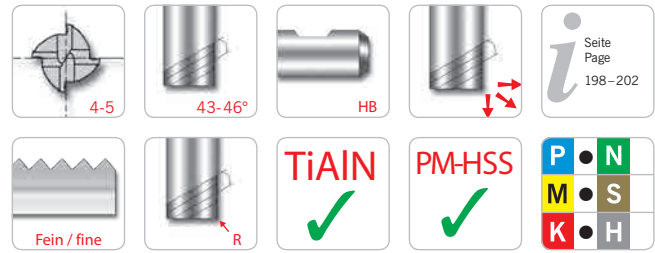

AFR619.3-...-PM

Schaft / Shank DIN 6535HB	d js12	d _A h6	l ₁	l	R	z
AFR61943-060-PM N	6,0	6	13	57	0,50	4
AFR61943-080-PM N	8,0	10	19	69	0,50	4
AFR61943-100-PM N	10,0	10	22	72	0,50	4
AFR61943-120-PM N	12,0	12	26	83	0,50	4
AFR61953-160-PM N	16,0	16	32	92	1,00	5
AFR61953-200-PM N	20,0	20	38	104	1,00	5

Toleranz / Tolerance (μm)	Nennwertbereich / Diameter range (mm)		
	> 6 - 10	> 10 - 18	> 18 - 30
js12	±75	±90	±105
h6	0 -9	0 -11	0 -13

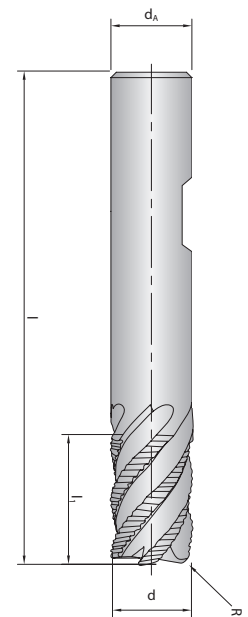

AFR

● = Hauptanwendung / Main application
○ = Nebenanwendung / Suitable

Alle Angaben in mm / Dimensions in mm

Empfohlene Schnittwerte VHM-Schafffräser und PM-HSS-Fräser

Ausführung AFR

AFR

ISO	Werkstoff	Festigkeit [N/mm ²]	Vorschub-Korrekturfaktor [x f ₁]	VHM-Schafffräser		PM-HSS-Fräser	
				Schrupp- und Nutfräsen	Schlicht- und Konturfräsen	Schrupp- und Nutfräsen	Schlicht- und Konturfräsen
				VHM AlCrN V _c [m/min]	VHM AlCrN V _c [m/min]	PM-HSS TiAlN V _c [m/min]	PM-HSS TiAlN V _c [m/min]
P	Allgemeiner Baustahl	< 800	1,2	150-170	170-200	60-70	50-60
	Automatenstahl	< 800	1,2	170-190	190-220	60-70	50-60
	Einsatzstahl, unlegiert	< 800	1,2	140-170	170-190	60-70	50-60
	Einsatzstahl, legiert	< 1000	1	100-140	140-180	30-40	25-35
	Vergütungsstahl, unlegiert	< 850	1,2	140-170	170-190	30-40	25-35
	Vergütungsstahl, unlegiert	< 1000	1	120-140	140-160	30-40	25-35
	Vergütungsstahl, legiert	< 800	1,2	100-140	140-170	30-40	25-35
	Vergütungsstahl, legiert	< 1300	0,8	100-120	120-160	28-35	25-30
	Stahlguss	< 850	1,2	150-170	170-200	30-35	25-30
	Nitrierstahl	< 1000	0,8			30-35	25-30
	Nitrierstahl	< 1200	0,8			25-30	20-25
	Wälzlagerstahl	< 1200	0,8	140-170	170-190	25-30	20-25
	Federstahl	< 1200	0,8			25-30	20-25
	Schnellarbeitsstahl	< 1300	0,8			25-30	20-25
	Werkzeugstahl für Kaltarbeit	< 1300	0,8	80-120	120-150	25-35	20-30
Werkzeugstahl für Warmarbeit	< 1300	0,8	80-120	120-150	25-35	20-30	
M	Stahl und Stahlguss, rostfrei geschwefelt	< 850	1			25-35	20-30
	Nichtrostender Stahl, ferritisch	< 750	1			25-35	20-30
	Nichtrostender Stahl, martensitisch	< 900	1			20-30	15-25
	Nichtrostender Stahl, ferritisch/martensitisch	< 1100	0,9			15-25	10-20
	Nichtrostender Stahl, austenitisch/ferritisch	< 850	1			25-35	20-30
	Nichtrostender Stahl, austenitisch	< 750	1			30-35	25-30
K	Hitzebeständig	< 1100	0,9			25-30	20-25
	Grauguss mit Lammellengraphit	100-350	1	100-130	130-150	40-55	35-45
	Grauguss mit Lammellengraphit	300-1000	1	100-120	120-140	30-40	25-35
	Kugelgraphitguss	300-500	1	100-120	120-140	35-45	30-40
	Kugelgraphitguss	550-800	1	80-100	100-120	35-45	30-40
	Temperguss, weiß	350-450	1	100-120	120-140	40-50	35-45
	Temperguss, weiß	500-650	1	80-100	100-120	40-50	35-45
	Temperguss, schwarz	350-450	1	100-120	120-140	35-45	30-40
Temperguss, schwarz	500-700	0,8	80-100	100-120	30-40	25-35	
N	Aluminium (unlegiert, niedrig legiert)	< 350					
	Aluminiumlegierungen < 0,5% Si	< 500					
	Aluminiumlegierungen 0,5 - 10% Si	< 400					
	Aluminiumlegierungen 10 - 15% Si	< 400					
	Aluminiumlegierungen > 15% Si	< 400					
	Kupfer (unlegiert, niedrig legiert)	< 350					
	Kupfer-Knetlegierungen	< 700					
	Kupfer-Sonderlegierungen	< 200 HB					
	Kupfer-Sonderlegierungen	< 300 HB					
	Kupfer-Sonderlegierungen	> 300 HB					
	Messing kurzspanend, Bronze, Rotguss	< 600					
	Messing langspanend	< 600					
	Thermoplaste						
	Duroplaste						
	Faserverstärkte Kunststoffe						
	Magnesium und Magnesiumlegierungen	< 850					
	Graphit						
Wolfram und Wolframlegierungen							
Molybdän und Molybdänlegierungen							
S	Reinnickel						
	Nickellegierungen						
	Nickellegierungen	< 850					
	Nickel-Chromlegierungen						
	Nickel- und Kobaltlegierungen	< 1300					
	Hochwarmfeste Legierungen	< 1300					
	Nickel-Kobalt-(Chrom-)legierungen	< 1400					
	Nickel- und Kobaltlegierungen	< 1300					
	Reintitan	< 900					
	Titanlegierungen	< 700					
Titanlegierungen	< 1200						
H	Stahl gehärtet	< 45 HRC					
	Stahl gehärtet	46-55 HRC					
	Stahl gehärtet	56-60 HRC					
	Stahl gehärtet	61-65 HRC					
	Stahl gehärtet	65-70 HRC					

Die Tabellenwerte sind Richtwerte. Es kann notwendig sein, die Werte den jeweiligen Bearbeitungsumständen anzupassen.

Recommended cutting data Solid carbide end-mill and PM-HSS end-mill

Design AFR

ISO	Material	Strength [N/mm ²]	Correction factor [x f _z]	Solid carbide end-mill		PM-HSS end-mill	
				Roughing and full slot milling	Peripheral- and contour milling	Roughing and full slot milling	Peripheral- and contour milling
				VHM AlCrN V _c [m/min]	VHM AlCrN V _c [m/min]	PM-HSS TiAlN V _c [m/min]	PM-HSS TiAlN V _c [m/min]
P	General construction steel	< 800	1,2	150-170	170-200	60-70	50-60
	Free cutting steel	< 800	1,2	170-190	190-220	60-70	50-60
	Case hardened steel, non alloyed	< 800	1,2	140-170	170-190	60-70	50-60
	Alloyed case hardened steel	< 1000	1	100-140	140-180	30-40	25-35
	Tempering steel, non alloyed	< 850	1,2	140-170	170-190	30-40	25-35
	Tempering steel, non alloyed	< 1000	1	120-140	140-160	30-40	25-35
	Tempering steel, alloyed	< 800	1,2	100-140	140-170	30-40	25-35
	Tempering steel, alloyed	< 1300	0,8	100-120	120-160	28-35	25-30
	Steel castings	< 850	1,2	150-170	170-200	30-35	25-30
	Nitriding steel	< 1000	0,8			30-35	25-30
	Nitriding steel	< 1200	0,8			25-30	20-25
	Roller bearing steel	< 1200	0,8	140-170	170-190	25-30	20-25
	Spring steel	< 1200	0,8			25-30	20-25
	High-speed steel	< 1300	0,8			25-30	20-25
	Cold working tool steel	< 1300	0,8	80-120	120-150	25-35	20-30
Hot working tool steel	< 1300	0,8	80-120	120-150	25-35	20-30	
M	Steel and sulphured cast stainless steel	< 850	1			25-35	20-30
	Stainless steel, ferritic	< 750	1			25-35	20-30
	Stainless steel, martensitic	< 900	1			20-30	15-25
	Stainless steel, ferritic/martensitic	< 1100	0,9			15-25	10-20
	Stainless steel, austenitic/ferritic	< 850	1			25-35	20-30
	Stainless steel, austenitic	< 750	1			30-35	25-30
	Heat resistant steel	< 1100	0,9			25-30	20-25
K	Grey cast iron with lamellar graphite	100-350	1	100-130	130-150	40-55	35-45
	Grey cast iron with lamellar graphite	300-1000	1	100-120	120-140	30-40	25-35
	Spheroidal cast iron	300-500	1	100-120	120-140	35-45	30-40
	Spheroidal cast iron	550-800	1	80-100	100-120	35-45	30-40
	White cast iron, tempered	350-450	1	100-120	120-140	40-50	35-45
	White cast iron, tempered	500-650	1	80-100	100-120	40-50	35-45
	Black cast iron, tempered	350-450	1	100-120	120-140	35-45	30-40
	Black cast iron, tempered	500-700	0,8	80-100	100-120	30-40	25-35
N	Aluminium (non alloyed, low alloyed)	< 350					
	Aluminium alloys < 0,5% Si	< 500					
	Aluminium alloys 0,5% - 10% Si	< 400					
	Aluminium alloys 10% - 15% Si	< 400					
	Aluminium alloys > 15% Si	< 400					
	Copper (non alloyed, low alloyed)	< 350					
	Copper wrought alloys	< 700					
	Special copper alloys	< 200 HB					
	Special copper alloys	< 300 HB					
	Special copper alloys	> 300 HB					
	Short-chipping brass, bronze, red bronze	< 600					
	Long-chipping brass	< 600					
	Thermoplastics						
	Duroplastics						
	Fibre-reinforced plastics						
	Magnesium and magnesium alloys	< 850					
	Graphite						
Tungsten and tungsten alloys							
Molybdenum and molybdenum alloys							
S	Pure nickel						
	Nickel alloys						
	Nickel alloys	< 850					
	Nickel-chromium alloys						
	Nickel and cobalt alloys	< 1300					
	Nickel and cobalt alloys	< 1300					
	Heat resistant alloys	< 1400					
	Nickel-cobalt-chromium alloys	< 1300					
	Pure titanium	< 900					
	Titanium alloys	< 700					
Titanium alloys	< 1200						
H	Tempered steel	< 45 HRC					
	Tempered steel	46-55 HRC					
	Tempered steel	56-60 HRC					
	Tempered steel	61-65 HRC					
	Tempered steel	65-70 HRC					

The recommended cutting data are only approximate values. It may be necessary to adjust them to each individual machining application.

AFR

Für die nachfolgenden Vorschub-Richtwerte müssen die Werte je nach zu bearbeitendem Material gemäß dem in den Schnittgeschwindigkeitstabellen angegebenen Korrekturfaktor $K_f [f_z]$ korrigiert werden.

For the following feed tables the values must be corrected depending on the material being machined in line with the correction factor $K_f [f_z]$.

Beispiel für Fräser mit Schneidendurchmesser 6 mm:

An example using a cutter with \varnothing 6 mm is detailed:

Schnittgeschwindigkeits-Tabelle / V_c -table

ISO	Werkstoff / Material	Festigkeit Strength [N/mm ² - HB]	$K_f [x f_z]$	TiAlN V_c [m/min]
P	Allgemeiner Baustahl General construction steel	< 800 N/mm ²	1,2	100 - 150
	Automatenstahl Free cutting steel	< 800 N/mm ²	1,2	100 - 150
	Einsatzstahl, unlegiert Case hardened steel, non alloyed	< 800 N/mm ²	1,2	100 - 150
	Einsatzstahl, legiert Alloyed case hardened steel	< 1000 N/mm ²	1	90 - 120
	Vergütungsstahl, unlegiert Tempering steel, non alloyed	< 850 N/mm ²	1,2	90 - 130
	Vergütungsstahl, unlegiert Tempering steel, non alloyed	< 1000 N/mm ²	1	60 - 90
	Vergütungsstahl, legiert Tempering steel, alloyed	< 800 N/mm ²	1,2	90 - 120
	Vergütungsstahl, legiert Tempering steel, alloyed	< 1300 N/mm ²	0,8	60 - 80
	Stahlguss Steel castings	< 850 N/mm ²	1,2	70 - 100

Korrekturfaktor-Tabelle / f_z -table

$\varnothing d_1$ [mm]	Korrekturfaktor/ Correction factor $K_f [f_z]$		
	1	0,7	0,8
1	0,004	0,003	0,003
2	0,008	0,006	0,006
3	0,012	0,008	0,010
4	0,016	0,011	0,013
5	0,020	0,014	0,016
6	0,024	0,017	0,019
8	0,032	0,022	0,026

Für legierten Einsatzstahl gilt der Vorschubwert aus der Korrekturfaktor-Tabelle.

$K_f (f_z) = 1$ (entsprechend 100%) $f_z = 0,024$

Für legierten Vergütungsstahl < 1300 N/mm² wird der Vorschubwert aus der Korrekturfaktor-Tabelle um 20% reduziert.

$K_f (f_z) = 0,8$ (entsprechend 80%) $f_z = 0,019$

For case-hardening alloy steel the feed value from the table is valid:

$K_f (f_z) = 1$ (according to 100%) $f_z = 0,024$

For heat treatable steel alloys < 1300 N/mm² the feed value from the table is reduced by 20%.

$K_f [fz] = 0,8$ (according to 80%) $fz = 0,019$

Generelle Berechnungsformeln / General rule:

Vorschub pro Zahn / Feed per tooth: $= f_z \cdot K_f (f_z)$

Bohrvorschub (Fräsen in axialer Richtung): = Tabellenwert / Zähnezahl

For axial plunge milling: = Table value / Number of teeth

AFR

VHM-Schaftfräser / Solid carbide end-mill

Vorschub pro Zahn bei einer radialen Zustellung 50% vom Schneidendurchmesser ($\varnothing d_1$)

Feed per tooth with radial depth of cut of 50% of the cutter ($\varnothing d_1$)

$\varnothing d_1$ [mm]	Korrekturfaktor / Correction factor $K_f [f_z]$						
	1	0,7	0,8	0,9	1,1	1,2	1,5
6	0,030	0,021	0,024	0,027	0,033	0,036	0,045
8	0,050	0,035	0,040	0,045	0,055	0,060	0,075
10	0,060	0,042	0,045	0,055	0,066	0,072	0,090
12	0,070	0,049	0,056	0,063	0,077	0,084	0,105
16	0,090	0,034	0,072	0,081	0,099	0,108	0,135
20	0,120	0,084	0,090	0,108	0,132	0,144	0,180

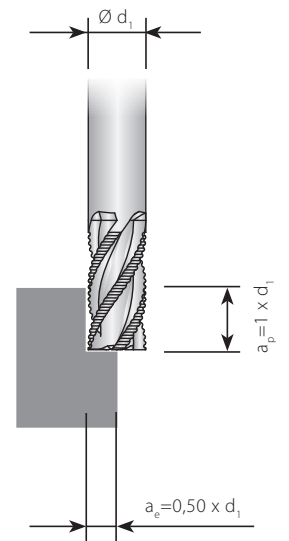

Vorschub pro Zahn beim Vollnutfräsen $\rightarrow a_p = 1 \times d_1$

Feed per tooth when full slot milling $\rightarrow a_p = 1 \times d_1$

$\varnothing d_1$ [mm]	Korrekturfaktor / Correction factor $K_f [f_z]$						
	1	0,7	0,8	0,9	1,1	1,2	1,5
6	0,028	0,020	0,022	0,025	0,031	0,035	0,042
8	0,040	0,028	0,032	0,036	0,044	0,048	0,060
10	0,050	0,035	0,040	0,045	0,055	0,060	0,075
12	0,060	0,042	0,048	0,054	0,066	0,072	0,090
16	0,080	0,056	0,064	0,072	0,088	0,096	0,120
20	0,100	0,070	0,089	0,090	0,110	0,120	0,150

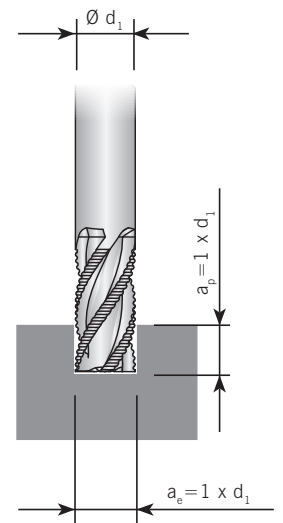

Achtung:

Vorschub-Korrekturfaktor $\rightarrow K_f f_z = 1,10$ bei $a_p = 1 \times d_1$ und $\rightarrow K_f f_z = 1,25$ bei $a_p = 0,5 \times d_1$
Für unbeschichtete Werkzeuge ist der Vorschub um 10-20% zu reduzieren.

Attention:

Feed rate correction factor $\rightarrow K_f f_z = 1,10$ with $a_p = 1 \times d_1$ and $\rightarrow K_f f_z = 1,25$ with $a_p = 0,5 \times d_1$
Feed rates are reduced by 10-20% for uncoated tools.

PM-HSS Schafffräser / PM-HSS end-mill

Vorschub pro Zahn bei einer radialen Zustellung 50% vom Schneidendurchmesser ($\varnothing d_1$)

Feed per tooth with radial depth of cut of 50% of the cutter ($\varnothing d_1$)

$\varnothing d_1$ [mm]	Korrekturfaktor / Correction factor Kf [f_z]						
	1	0,7	0,8	0,9	1,1	1,2	1,5
6	0,022	0,015	0,018	0,020	0,024	0,026	0,033
8	0,030	0,021	0,024	0,027	0,030	0,035	0,045
10	0,039	0,027	0,030	0,035	0,042	0,047	0,060
12	0,047	0,033	0,037	0,042	0,050	0,056	0,070
16	0,066	0,046	0,052	0,060	0,070	0,080	0,100
20	0,084	0,059	0,067	0,075	0,092	0,100	0,130

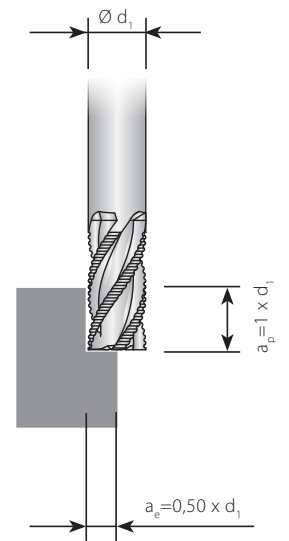

Vorschub pro Zahn beim Vollnutfräsen → $a_p = 1 \times d_1$

Feed per tooth when full slot milling → $a_p = 1 \times d_1$

$\varnothing d_1$ [mm]	Korrekturfaktor / Correction factor Kf [f_z]						
	1	0,7	0,8	0,9	1,1	1,2	1,5
6	0,019	0,013	0,015	0,017	0,020	0,023	0,025
8	0,026	0,018	0,020	0,023	0,028	0,031	0,040
10	0,034	0,029	0,028	0,030	0,037	0,041	0,050
12	0,041	0,029	0,033	0,037	0,045	0,049	0,060
16	0,057	0,040	0,046	0,050	0,063	0,070	0,080
20	0,073	0,050	0,060	0,065	0,080	0,090	0,110

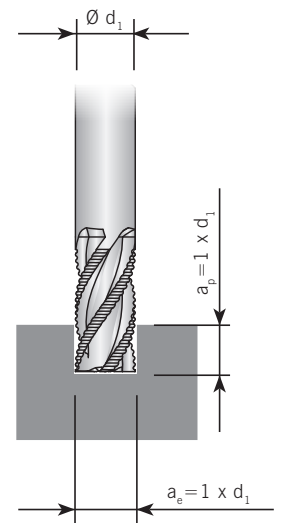

AFR

Achtung:

Vorschub-Korrekturfaktor → Kf $f_z = 1,10$ bei $a_p = 1 \times d_1$ und → Kf $f_z = 1,25$ bei $a_p = 0,5 \times d_1$
Für unbeschichtete Werkzeuge ist der Vorschub um 10-20% zu reduzieren.

Attention:

Feed rate correction factor → Kf $f_z = 1,10$ with $a_p = 1 \times d_1$ and → Kf $f_z = 1,25$ with $a_p = 0,5 \times d_1$
Feed rates are reduced by 10-20% for uncoated tools.

ARNO[®]

WERKZEUGE

We have a passion for precision.

AUSFÜHRUNG AFH

Design AFH

Nimmt's auch mit den Harten auf.

For the really hard jobs.

Die ARNO[®] AFH VHM-Fräser sind für gehärtete Stähle bis 70 HRC sowie für Gussformen im Werkzeugbau und die HSC-Bearbeitung geeignet – auch Trockenbearbeitung ist möglich.



This series is suitable for milling steel up to 70 HRC as well as high speed milling. Can be run dry.

VHM-Schaftfräser

2 Schneiden, Mini-Ausführung, mit Eckenradius



Solid carbide end-mill

2 flutes, mini design, with corner radius

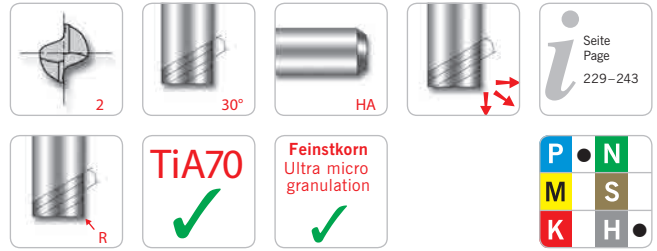

AFH50120-...R...

AFH

Schaft / Shank DIN 6535HA	d	d _A	l ₁	l	R
AFH50120-003	0,3	6	0,45	50	-
AFH50120-004	0,4	6	0,60	50	-
AFH50120-005R0,05	0,5	6	0,70	50	0,05
AFH50120-006R0,05	0,6	6	0,90	50	0,05
AFH50120-008R0,05	0,8	6	1,20	50	0,05
AFH50120-010R0,1	1,0	6	1,50	50	0,10
AFH50120-012R0,1	1,2	6	1,80	50	0,10
AFH50120-015R0,15	1,5	6	2,20	50	0,15
AFH50120-020R0,15	2,0	6	2,20	50	0,15

Toleranz / Tolerance	
Fräser / Mill	0 -0,012
Radius / Radius	± 0,01
Schaft / Shank	h6

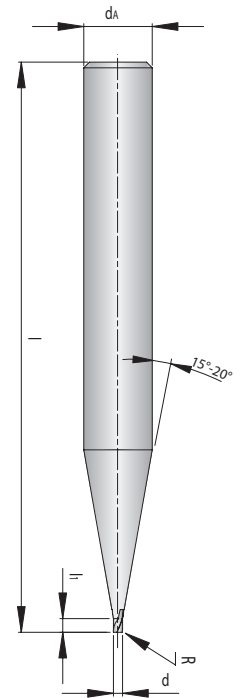

VHM-Schaftfräser (Schlitzfräsen)

2 Schneiden, Mini-Ausführung

Solid carbide end-mill (Slotting)

2 flutes, mini design

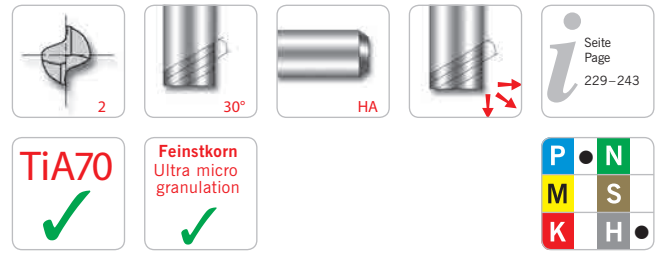
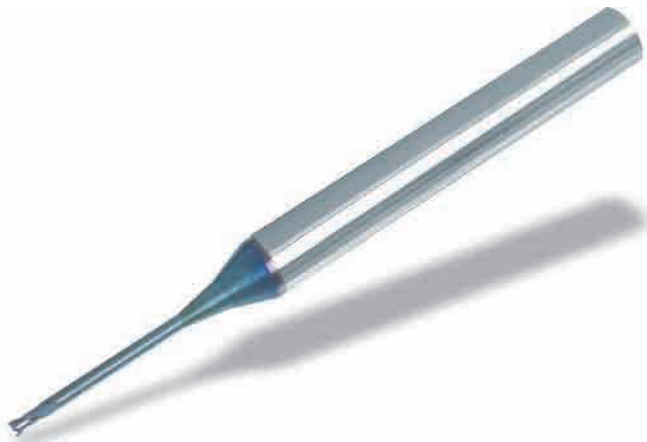

AFH50526-...

Schaft / Shank DIN 6535HA	d	d _A	d ₃	l ₁	l ₂	l
AFH50526-001A	0,1	4	0,085	0,15	0,3	45
AFH50526-001B	0,1	4	0,085	0,15	0,5	45
AFH50526-002A	0,2	4	0,18	0,30	0,5	45
AFH50526-002B	0,2	4	0,18	0,30	1,0	45
AFH50526-002C	0,2	4	0,18	0,30	1,5	45
AFH50526-003A	0,3	4	0,27	0,45	1,0	45
AFH50526-003B	0,3	4	0,27	0,45	1,5	45
AFH50526-003C	0,3	4	0,27	0,45	2,0	45
AFH50526-003D	0,3	4	0,27	0,45	3,0	45
AFH50526-003E	0,3	4	0,27	0,45	4,0	45
AFH50526-004A	0,4	4	0,37	0,60	1,0	45
AFH50526-004B	0,4	4	0,37	0,60	2,0	45
AFH50526-004C	0,4	4	0,37	0,60	3,0	45
AFH50526-004D	0,4	4	0,37	0,60	4,0	45
AFH50526-004E	0,4	4	0,37	0,60	5,0	45
AFH50526-005A	0,5	4	0,45	0,70	2,0	45
AFH50526-005B	0,5	4	0,45	0,70	2,5	45
AFH50526-005C	0,5	4	0,45	0,70	4,0	45
AFH50526-005D	0,5	4	0,45	0,70	6,0	45
AFH50526-005E	0,5	4	0,45	0,70	8,0	45
AFH50526-006A	0,6	4	0,55	0,90	2,0	45
AFH50526-006B	0,6	4	0,55	0,90	3,0	45
AFH50526-006C	0,6	4	0,55	0,90	4,0	45
AFH50526-006D	0,6	4	0,55	0,90	6,0	45
AFH50526-006E	0,6	4	0,55	0,90	8,0	45
AFH50526-006F	0,6	4	0,55	0,90	10,0	45
AFH50526-008A	0,8	4	0,75	1,20	2,0	45
AFH50526-008B	0,8	4	0,75	1,20	4,0	45
AFH50526-008C	0,8	4	0,75	1,20	6,0	45
AFH50526-008D	0,8	4	0,75	1,20	8,0	45
AFH50526-008E	0,8	4	0,75	1,20	10,0	45
AFH50526-008F	0,8	4	0,75	1,20	12,0	45
AFH50526-010A	1,0	4	0,95	1,50	4,0	45
AFH50526-010B	1,0	4	0,95	1,50	6,0	45
AFH50526-010C	1,0	4	0,95	1,50	8,0	45
AFH50526-010D	1,0	4	0,95	1,50	10,0	45
AFH50526-010E	1,0	4	0,95	1,50	12,0	45
AFH50526-010F	1,0	4	0,95	1,50	16,0	50
AFH50526-010G	1,0	4	0,95	1,50	20,0	55
AFH50526-012A	1,2	4	1,15	1,80	6,0	45
AFH50526-012B	1,2	4	1,15	1,80	8,0	45
AFH50526-012C	1,2	4	1,15	1,80	10,0	45
AFH50526-012D	1,2	4	1,15	1,80	12,0	45

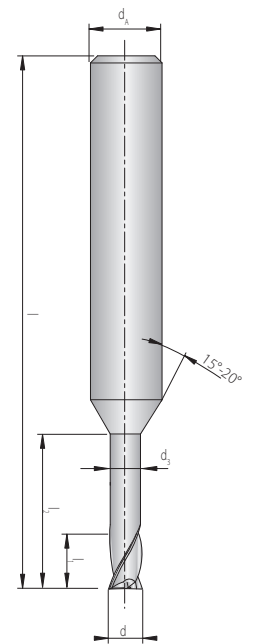

AFH

● = Hauptanwendung / Main application
○ = Nebenanwendung / Suitable

Alle Angaben in mm / Dimensions in mm

VHM-Schaftfräser (Schlitzfräsen)

2 Schneiden, Mini-Ausführung

Solid carbide end-mill (Slotting)

2 flutes, mini design

AFH50526-...

Schaft / Shank DIN 6535HA	d	d _A	d ₃	l ₁	l ₂	l
AFH50526-012E	1,2	4	1,15	1,80	16,0	50
AFH50526-015A	1,5	4	1,45	2,30	6,0	45
AFH50526-015B	1,5	4	1,45	2,30	8,0	45
AFH50526-015C	1,5	4	1,45	2,30	10,0	45
AFH50526-015D	1,5	4	1,45	2,30	12,0	45
AFH50526-015E	1,5	4	1,45	2,30	14,0	50
AFH50526-015F	1,5	4	1,45	2,30	16,0	50
AFH50526-015G	1,5	4	1,45	2,30	18,0	55
AFH50526-015H	1,5	4	1,45	2,30	20,0	55
AFH50526-020A	2,0	4	1,95	3,00	6,0	45
AFH50526-020B	2,0	4	1,95	3,00	8,0	45
AFH50526-020C	2,0	4	1,95	3,00	10,0	45
AFH50526-020D	2,0	4	1,95	3,00	12,0	45
AFH50526-020E	2,0	4	1,95	3,00	14,0	50
AFH50526-020F	2,0	4	1,95	3,00	16,0	50
AFH50526-020G	2,0	4	1,95	3,00	18,0	55
AFH50526-020H	2,0	4	1,95	3,00	20,0	55
AFH50526-020J	2,0	4	1,95	3,00	25,0	60
AFH50526-020K	2,0	4	1,95	3,00	30,0	70
AFH50526-030A	3,0	6	2,85	4,50	10,0	45
AFH50526-030B	3,0	6	2,85	4,50	12,0	45
AFH50526-030C	3,0	6	2,85	4,50	14,0	50
AFH50526-030D	3,0	6	2,85	4,50	16,0	55
AFH50526-030E	3,0	6	2,85	4,50	18,0	55
AFH50526-030F	3,0	6	2,85	4,50	20,0	60
AFH50526-030G	3,0	6	2,85	4,50	25,0	65
AFH50526-030H	3,0	6	2,85	4,50	30,0	70
AFH50526-030J	3,0	6	2,85	4,50	35,0	80
AFH50526-030K	3,0	6	2,85	4,50	40,0	90
AFH50526-040A	4,0	6	3,85	6,00	12,0	50
AFH50526-040B	4,0	6	3,85	6,00	16,0	60
AFH50526-040C	4,0	6	3,85	6,00	20,0	60
AFH50526-040D	4,0	6	3,85	6,00	25,0	70
AFH50526-040E	4,0	6	3,85	6,00	30,0	70
AFH50526-040F	4,0	6	3,85	6,00	35,0	80
AFH50526-040G	4,0	6	3,85	6,00	40,0	90
AFH50526-040H	4,0	6	3,85	6,00	45,0	90
AFH50526-040J	4,0	6	3,85	6,00	50,0	100

Toleranz / Tolerance	
Fräser / Mill	0 -0,012
Schaft / Shank	h6

● = Hauptanwendung / Main application
○ = Nebenanwendung / Suitable

Alle Angaben in mm / Dimensions in mm

VHM-Schaftfräser (Schlitzfräsen)

2 Schneiden, Mini-Ausführung, mit Eckenradius



Solid carbide end-mill (Slotting)

2 flutes, mini design, with corner radius

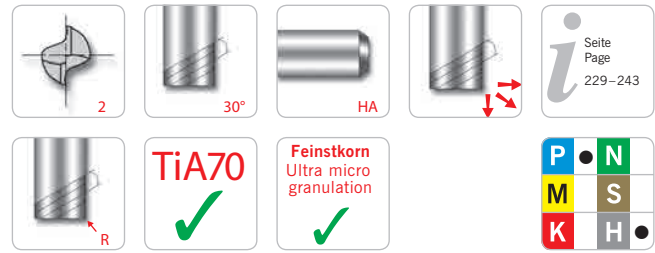

AFH50920-...R...

Schaft / Shank DIN 6535HA	d	d _A	d ₃	l ₁	l ₂	l	R
AFH50920-005AR0,05	0,5	6	0,45	0,70	1,5	50	0,05
AFH50920-005BR0,05	0,5	6	0,45	0,70	3,3	50	0,05
AFH50920-006AR0,05	0,6	6	0,55	0,90	2,0	50	0,05
AFH50920-006BR0,05	0,6	6	0,55	0,90	4,0	50	0,05
AFH50920-008AR0,05	0,8	6	0,75	1,20	2,5	50	0,05
AFH50920-008BR0,05	0,8	6	0,75	1,20	5,5	50	0,05
AFH50920-010AR0,1	1,0	6	0,95	1,50	3,3	50	0,10
AFH50920-010BR0,1	1,0	6	0,95	1,50	6,7	50	0,10
AFH50920-012AR0,1	1,2	6	1,15	1,80	4,4	50	0,10
AFH50920-012BR0,1	1,2	6	1,15	1,80	8,0	50	0,10
AFH50920-015AR0,15	1,5	6	1,45	2,20	5,0	50	0,15
AFH50920-015BR0,15	1,5	6	1,45	2,20	9,7	50	0,15
AFH50920-020AR0,15	2,0	6	1,95	2,20	6,0	50	0,15
AFH50920-020BR0,15	2,0	6	1,95	2,20	13,0	50	0,15

Toleranz / Tolerance

Fräser / Mill	0
Radius / Radius	± 0,01
Schaft / Shank	h6

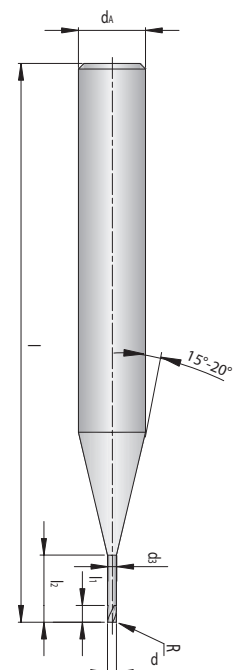

AFH

● = Hauptanwendung / Main application
○ = Nebenanwendung / Suitable

Alle Angaben in mm / Dimensions in mm

VHM-Radiusfräser

2 Schneiden, Mini-Ausführung

Solid carbide ball-nose end-mill

2 flutes, mini design

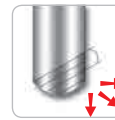
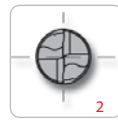

AFH50320-...

Schaft / Shank DIN 6535HA	d	d _A	l ₁	l	R
AFH50320-004	0,4	6	0,40	50	0,20
AFH50320-005	0,5	6	0,50	50	0,25
AFH50320-006	0,6	6	0,60	50	0,30
AFH50320-008	0,8	6	0,80	50	0,40
AFH50320-010	1,0	6	1,00	50	0,50
AFH50320-012	1,2	6	1,20	50	0,60
AFH50320-015	1,5	6	1,50	50	0,75
AFH50320-020	2,0	6	2,00	50	1,00

Toleranz / Tolerance	
Fräser / Mill	0 -0,012
Radius / Radius	± 0,01
Schaft / Shank	h6

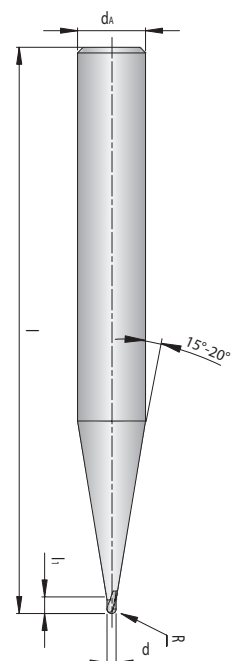

AFH

VHM-Radiusfräser (Schlitzfräsen)

2 Schneiden, Mini-Ausführung



AFH52020-...

Solid carbide ball-nose end-mill (Slotting)

2 flutes, mini design

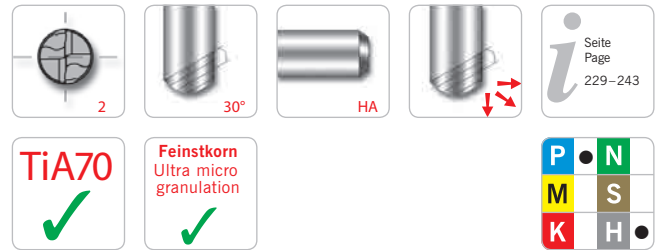

Schaft / Shank DIN 6535HA	d	d _A	d ₃	l ₁	l ₂	l	R
AFH52020-005A	0,5	6	0,45	0,50	1,5	50	0,25
AFH52020-005B	0,5	6	0,45	0,50	3,3	50	0,25
AFH52020-006A	0,6	6	0,55	0,60	2,0	50	0,30
AFH52020-006B	0,6	6	0,55	0,60	4,0	50	0,30
AFH52020-008A	0,8	6	0,75	0,80	2,5	50	0,40
AFH52020-008B	0,8	6	0,75	0,80	5,5	50	0,40
AFH52020-010A	1,0	6	0,95	1,00	3,3	50	0,50
AFH52020-010B	1,0	6	0,95	1,00	6,7	50	0,50
AFH52020-010C	1,0	6	0,95	1,00	12,0	50	0,50
AFH52020-012A	1,2	6	1,15	1,20	4,4	50	0,60
AFH52020-012B	1,2	6	1,15	1,20	8,0	50	0,60
AFH52020-015A	1,5	6	1,45	1,50	5,0	50	0,75
AFH52020-015B	1,5	6	1,45	1,50	9,7	50	0,75
AFH52020-015C	1,5	6	1,45	1,50	15,0	50	0,75
AFH52020-020A	2,0	6	1,95	2,00	6,0	50	1,00
AFH52020-020B	2,0	6	1,95	2,00	13,0	50	1,00
AFH52020-020C	2,0	6	1,95	2,00	20,0	60	1,00

Toleranz / Tolerance	
Fräser / Mill	0 -0,012
Radius / Radius	± 0,005
Schaft / Shank	h6

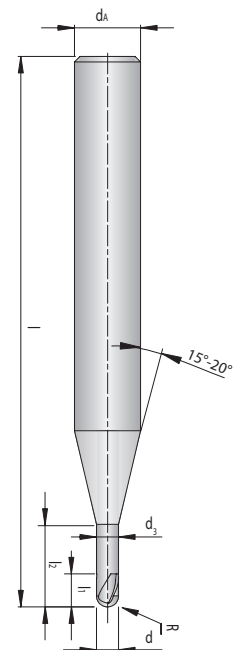

AFH

● = Hauptanwendung / Main application
○ = Nebenanwendung / Suitable

Alle Angaben in mm / Dimensions in mm

VHM-Radiusfräser (Schlitzfräsen)

2 Schneiden, Mini-Ausführung

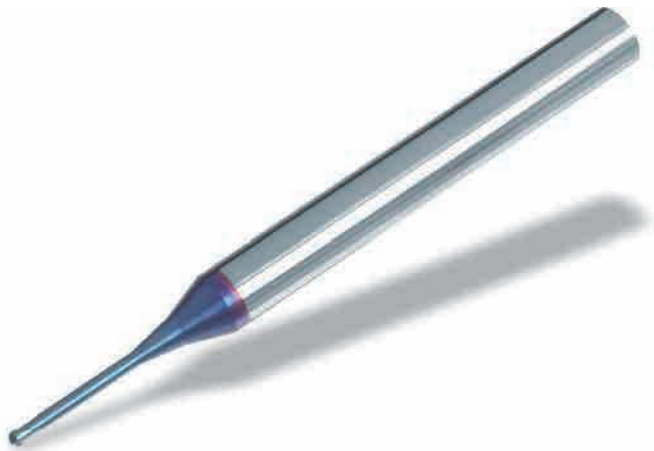

Solid carbide ball-nose end-mill (Slotting)

2 flutes, mini design

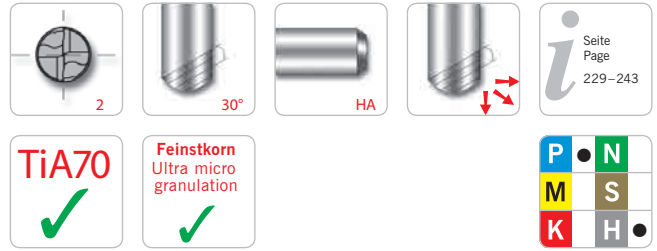

AFH52021-...

AFH

Schaft / Shank DIN 6535HA	d	d _A	d ₃	l ₁	l ₂	l	R
AFH52021-001A	0,1	4	0,085	0,10	0,3	45	0,05
AFH52021-001B	0,1	4	0,085	0,10	0,5	45	0,05
AFH52021-002A	0,2	4	0,18	0,20	0,5	45	0,10
AFH52021-002B	0,2	4	0,18	0,20	1,0	45	0,10
AFH52021-002C	0,2	4	0,18	0,20	1,5	45	0,10
AFH52021-003A	0,3	4	0,27	0,30	1,0	45	0,15
AFH52021-003B	0,3	4	0,27	0,30	2,0	45	0,15
AFH52021-003C	0,3	4	0,27	0,30	3,0	45	0,15
AFH52021-004A	0,4	4	0,37	0,40	1,0	45	0,20
AFH52021-004B	0,4	4	0,37	0,40	2,0	45	0,20
AFH52021-004C	0,4	4	0,37	0,40	3,0	45	0,20
AFH52021-004D	0,4	4	0,37	0,40	4,0	45	0,20
AFH52021-004E	0,4	4	0,37	0,40	5,0	45	0,20
AFH52021-005A	0,5	4	0,45	0,40	2,0	45	0,25
AFH52021-005B	0,5	4	0,45	0,40	2,5	45	0,25
AFH52021-005C	0,5	4	0,45	0,40	4,0	45	0,25
AFH52021-005D	0,5	4	0,45	0,40	6,0	45	0,25
AFH52021-005E	0,5	4	0,45	0,40	8,0	45	0,25
AFH52021-006A	0,6	4	0,55	0,50	2,0	45	0,30
AFH52021-006B	0,6	4	0,55	0,50	3,0	45	0,30
AFH52021-006C	0,6	4	0,55	0,50	4,0	45	0,30
AFH52021-006D	0,6	4	0,55	0,50	5,0	45	0,30
AFH52021-006E	0,6	4	0,55	0,50	6,0	45	0,30
AFH52021-006F	0,6	4	0,55	0,50	8,0	45	0,30
AFH52021-006G	0,6	4	0,55	0,50	10,0	45	0,30
AFH52021-008A	0,8	4	0,75	0,60	2,0	45	0,40
AFH52021-008B	0,8	4	0,75	0,60	4,0	45	0,40
AFH52021-008C	0,8	4	0,75	0,60	6,0	45	0,40
AFH52021-008D	0,8	4	0,75	0,60	8,0	45	0,40
AFH52021-008E	0,8	4	0,75	0,60	10,0	45	0,40
AFH52021-010A	1,0	4	0,95	0,80	3,0	45	0,50
AFH52021-010B	1,0	4	0,95	0,80	4,0	45	0,50
AFH52021-010C	1,0	4	0,95	0,80	5,0	45	0,50
AFH52021-010D	1,0	4	0,95	0,80	6,0	45	0,50
AFH52021-010E	1,0	4	0,95	0,80	7,0	45	0,50
AFH52021-010F	1,0	4	0,95	0,80	8,0	45	0,50
AFH52021-010G	1,0	4	0,95	0,80	9,0	45	0,50
AFH52021-010H	1,0	4	0,95	0,80	10,0	45	0,50
AFH52021-010J	1,0	4	0,95	0,80	12,0	45	0,50
AFH52021-010K	1,0	4	0,95	0,80	14,0	50	0,50
AFH52021-010L	1,0	4	0,95	0,80	16,0	50	0,50
AFH52021-010M	1,0	4	0,95	0,80	20,0	55	0,50
AFH52021-012A	1,2	4	1,15	1,00	6,0	45	0,60

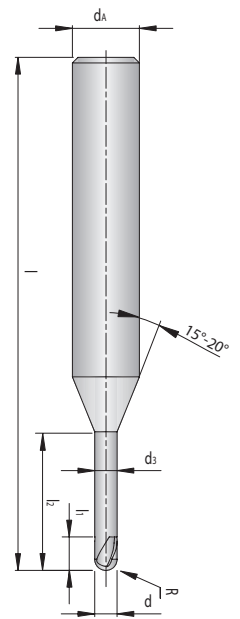

VHM-Radiusfräser (Schlitzfräsen)

2 Schneiden, Mini-Ausführung

Solid carbide ball-nose end-mill (Slotting)

2 flutes, mini design

AFH52021-...

Schaft / Shank DIN 6535HA	d	d _A	d ₃	l ₁	l ₂	l	R
AFH52021-012B	1,2	4	1,15	1,00	8,0	45	0,60
AFH52021-012C	1,2	4	1,15	1,00	10,0	45	0,60
AFH52021-012D	1,2	4	1,15	1,00	12,0	45	0,60
AFH52021-015A	1,5	4	1,45	1,20	6,0	45	0,75
AFH52021-015B	1,5	4	1,45	1,20	8,0	45	0,75
AFH52021-015C	1,5	4	1,45	1,20	10,0	45	0,75
AFH52021-015D	1,5	4	1,45	1,20	12,0	45	0,75
AFH52021-015E	1,5	4	1,45	1,20	14,0	50	0,75
AFH52021-015F	1,5	4	1,45	1,20	16,0	50	0,75
AFH52021-015G	1,5	4	1,45	1,20	20,0	55	0,75
AFH52021-020A	2,0	4	1,95	1,60	4,0	45	1,00
AFH52021-020B	2,0	4	1,95	1,60	6,0	45	1,00
AFH52021-020C	2,0	4	1,95	1,60	8,0	45	1,00
AFH52021-020D	2,0	4	1,95	1,60	10,0	45	1,00
AFH52021-020E	2,0	4	1,95	1,60	12,0	50	1,00
AFH52021-020F	2,0	4	1,95	1,60	14,0	50	1,00
AFH52021-020G	2,0	4	1,95	1,60	16,0	50	1,00
AFH52021-020H	2,0	4	1,95	1,60	18,0	55	1,00
AFH52021-020J	2,0	4	1,95	1,60	20,0	55	1,00
AFH52021-020K	2,0	4	1,95	1,60	22,0	60	1,00
AFH52021-020L	2,0	4	1,95	1,60	25,0	60	1,00
AFH52021-020M	2,0	4	1,95	1,60	30,0	70	1,00
AFH52021-030A	3,0	6	2,85	2,40	12,0	50	1,50
AFH52021-030B	3,0	6	2,85	2,40	14,0	55	1,50
AFH52021-030C	3,0	6	2,85	2,40	16,0	55	1,50
AFH52021-030D	3,0	6	2,85	2,40	18,0	60	1,50
AFH52021-030E	3,0	6	2,85	2,40	20,0	60	1,50
AFH52021-030F	3,0	6	2,85	2,40	25,0	65	1,50
AFH52021-030G	3,0	6	2,85	2,40	30,0	70	1,50
AFH52021-030H	3,0	6	2,85	2,40	35,0	80	1,50
AFH52021-040A	4,0	6	3,85	3,20	12,0	60	2,00
AFH52021-040B	4,0	6	3,85	3,20	16,0	60	2,00
AFH52021-040C	4,0	6	3,85	3,20	20,0	65	2,00
AFH52021-040D	4,0	6	3,85	3,20	25,0	70	2,00
AFH52021-040E	4,0	6	3,85	3,20	30,0	70	2,00
AFH52021-040F	4,0	6	3,85	3,20	35,0	80	2,00
AFH52021-040G	4,0	6	3,85	3,20	40,0	90	2,00
AFH52021-040H	4,0	6	3,85	3,20	45,0	90	2,00
AFH52021-040J	4,0	6	3,85	3,20	50,0	100	2,00

Toleranz / Tolerance	
Fräser / Mill	0 -0,012
Radius / Radius	± 0,005
Schaft / Shank	h6

● = Hauptanwendung / Main application
○ = Nebenanwendung / Suitable

Alle Angaben in mm / Dimensions in mm

VHM-Schaftfräser

2 Schneiden

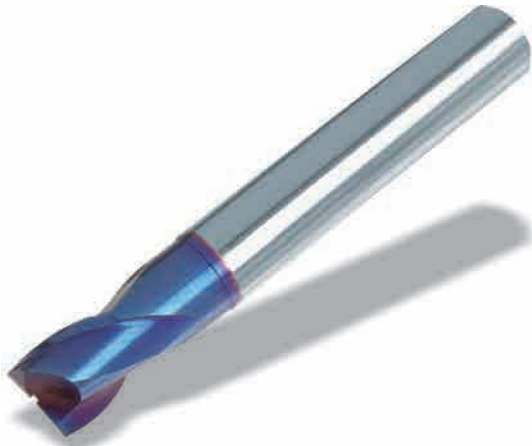

Solid carbide end-mill

2 flutes

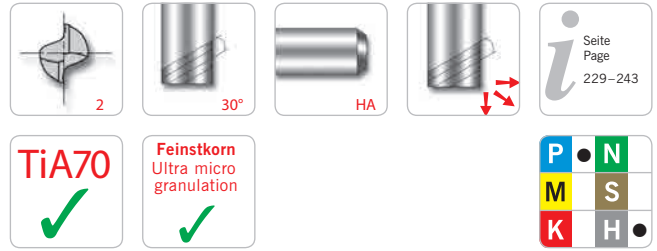

AFH50125-...

AFH

Schaft / Shank DIN 6535HA	d	d _A	d ₃	l ₁	l ₂	l
AFH50125-001	0,1	4	-	0,20	-	40
AFH50125-002	0,2	4	-	0,40	-	40
AFH50125-003	0,3	4	-	0,60	-	40
AFH50125-004	0,4	4	-	0,80	-	40
AFH50125-005	0,5	4	-	1,00	-	40
AFH50125-006	0,6	4	-	1,20	-	40
AFH50125-007	0,7	4	-	1,40	-	40
AFH50125-008	0,8	4	-	1,60	-	40
AFH50125-009	0,9	4	-	2,00	-	40
AFH50125-010	1,0	6	0,95	1,50	3,0	50
AFH50125-015	1,5	6	1,45	1,70	4,0	50
AFH50125-020	2,0	6	1,95	2,00	5,0	50
AFH50125-025	2,5	6	2,40	2,50	6,0	55
AFH50125-030	3,0	6	2,85	3,00	8,0	55
AFH50125-035	3,5	6	3,35	3,50	9,0	55
AFH50125-040	4,0	6	3,85	4,00	10,0	55
AFH50125-050	5,0	6	4,85	5,00	13,0	55
AFH50125-060	6,0	6	5,85	6,00	15,0	55
AFH50125-080	8,0	8	7,70	8,00	20,0	65
AFH50125-100	10,0	10	9,70	10,00	25,0	75
AFH50125-120	12,0	12	11,70	12,00	28,0	85
AFH50125-160	16,0	16	15,70	16,00	32,0	90
AFH50125-200	20,0	20	19,70	20,00	40,0	105

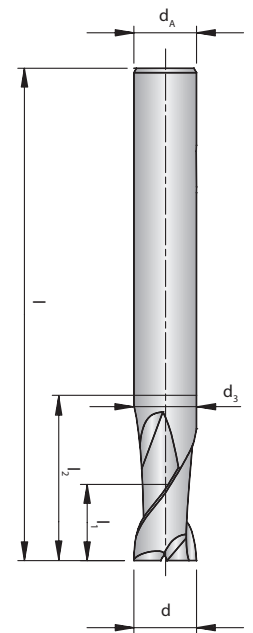

Toleranz / Tolerance	Nennwertbereich / Diameter range (mm)	
(µm)	<6	>6
Fräser / Mill	0	0
Schaft / Shank	-0,012	-0,016
	h6	h6

● = Hauptanwendung / Main application
○ = Nebenanwendung / Suitable

Alle Angaben in mm / Dimensions in mm

VHM-Schaftfräser

2 Schneiden, mit Eckenradius



Solid carbide end-mill

2 flutes, with corner radius

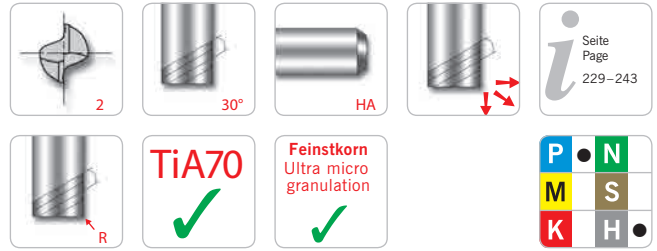

AFH50725-...R...

Schaft / Shank DIN 6535HA	d	d _A	d ₃	l ₁	l ₂	l	R
AFH50725-005R0,05	0,5	4	-	1,00	-	40	0,05
AFH50725-006R0,05	0,6	4	-	1,20	-	40	0,05
AFH50725-007R0,05	0,7	4	-	1,40	-	40	0,05
AFH50725-008R0,05	0,8	4	-	1,60	-	40	0,05
AFH50725-009R0,05	0,9	4	-	2,00	-	40	0,05
AFH50725-010AR0,1	1,0	4	-	1,50	-	40	0,10
AFH50725-010BR0,1	1,0	6	-	1,50	-	40	0,10
AFH50725-015R0,1	1,5	6	-	2,20	-	40	0,10
AFH50725-020AR0,1	2,0	4	1,95	3,00	6,0	40	0,10
AFH50725-020BR0,1	2,0	6	1,95	3,00	6,0	40	0,10
AFH50725-025R0,1	2,5	6	2,40	4,00	6,0	40	0,10
AFH50725-030R0,1	3,0	6	2,85	4,00	7,0	45	0,10
AFH50725-035R0,1	3,5	6	3,35	5,00	9,0	45	0,10
AFH50725-040R0,1	4,0	6	3,85	5,00	9,0	45	0,10
AFH50725-045R0,1	4,5	6	4,35	6,00	10,0	45	0,10
AFH50725-050R0,2	5,0	6	4,85	6,00	11,0	50	0,20
AFH50725-060R0,2	6,0	6	5,85	7,00	14,0	50	0,20
AFH50725-080R0,2	8,0	8	7,70	9,00	18,0	60	0,20
AFH50725-100R0,2	10,0	10	9,70	12,00	25,0	75	0,20
AFH50725-120R0,3	12,0	12	11,70	15,00	30,0	75	0,30
AFH50725-160R0,3	16,0	16	15,70	18,00	38,0	90	0,30
AFH50725-200R0,3	20,0	20	19,70	24,00	45,0	100	0,30

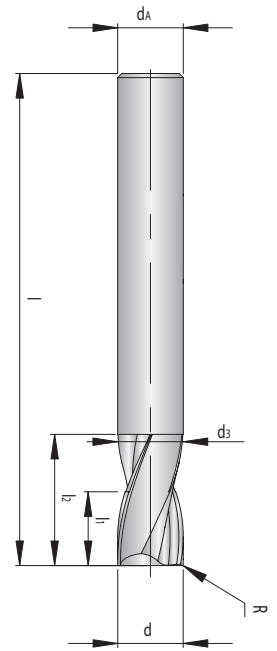

AFH

Toleranz / Tolerance (µm)	Nennwertbereich / Diameter range (mm)	
	<6	>6
Fräser / Mill	0 -0,012	0 -0,015
Radius / Radius	0 -0,01	0 -0,015
Schaft / Shank	h6	h6

● = Hauptanwendung / Main application
○ = Nebenanwendung / Suitable

Alle Angaben in mm / Dimensions in mm

VHM-Schaftfräser

2 Schneiden, mit Eckenradius

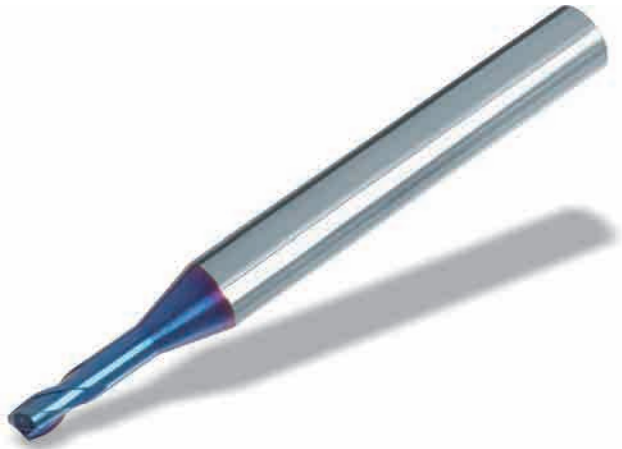

Solid carbide end-mill

2 flutes, with corner radius

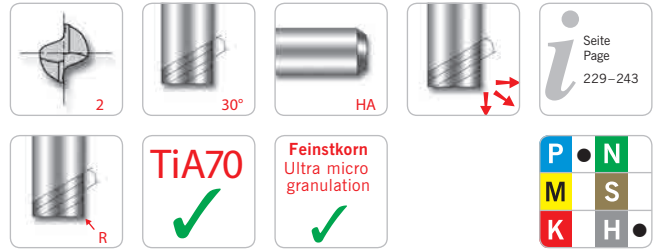

Seite
Page
229-243

AFH50926-...R...

AFH

Schaft / Shank DIN 6535HA	d	d _A	d ₃	l ₁	l ₂	l	R
AFH50926-005AR0,05	0,5	4	0,45	0,70	1,5	45	0,05
AFH50926-005BR0,05	0,5	4	0,45	0,70	2,5	45	0,05
AFH50926-005CR0,05	0,5	4	0,45	0,70	4,0	45	0,05
AFH50926-006AR0,05	0,6	4	0,55	0,90	2,0	45	0,05
AFH50926-006BR0,05	0,6	4	0,55	0,90	3,0	45	0,05
AFH50926-006CR0,05	0,6	4	0,55	0,90	4,0	45	0,05
AFH50926-006DR0,1	0,6	4	0,55	0,90	2,0	45	0,10
AFH50926-007R0,1	0,7	4	0,65	1,00	4,0	45	0,10
AFH50926-008AR0,1	0,8	4	0,75	1,20	2,0	45	0,10
AFH50926-008BR0,1	0,8	4	0,75	1,20	4,0	45	0,10
AFH50926-008CR0,1	0,8	4	0,75	1,20	6,0	45	0,10
AFH50926-010AR0,1	1,0	6	0,95	1,50	4,0	50	0,10
AFH50926-010BR0,1	1,0	6	0,95	1,50	6,0	50	0,10
AFH50926-010CR0,2	1,0	6	0,95	1,50	4,0	50	0,20
AFH50926-010DR0,2	1,0	6	0,95	1,50	6,0	50	0,20
AFH50926-010ER0,2	1,0	6	0,95	1,50	8,0	50	0,20
AFH50926-010FR0,3	1,0	6	0,95	1,50	4,0	50	0,30
AFH50926-010GR0,3	1,0	6	0,95	1,50	6,0	50	0,30
AFH50926-010HR0,3	1,0	6	0,95	1,50	8,0	50	0,30
AFH50926-015AR0,2	1,5	6	1,45	2,50	4,0	50	0,20
AFH50926-015BR0,2	1,5	6	1,45	2,50	6,0	50	0,20
AFH50926-015CR0,2	1,5	6	1,45	2,50	8,0	50	0,20
AFH50926-015DR0,2	1,5	6	1,45	2,50	10,0	50	0,20
AFH50926-015ER0,2	1,5	6	1,45	2,50	12,0	50	0,20
AFH50926-015FR0,3	1,5	6	1,45	2,50	4,0	50	0,30
AFH50926-015GR0,3	1,5	6	1,45	2,50	6,0	50	0,30
AFH50926-015HR0,3	1,5	6	1,45	2,50	8,0	50	0,30
AFH50926-020AR0,2	2,0	6	1,95	3,00	6,0	50	0,20
AFH50926-020BR0,2	2,0	6	1,95	3,00	8,0	50	0,20
AFH50926-020CR0,2	2,0	6	1,95	3,00	10,0	55	0,20
AFH50926-020DR0,2	2,0	6	1,95	3,00	12,0	55	0,20
AFH50926-020ER0,3	2,0	6	1,95	3,00	6,0	50	0,30
AFH50926-020FR0,3	2,0	6	1,95	3,00	8,0	50	0,30
AFH50926-020GR0,3	2,0	6	1,95	3,00	10,0	55	0,30
AFH50926-020HR0,3	2,0	6	1,95	3,00	12,0	55	0,30
AFH50926-020JR0,3	2,0	6	1,95	3,00	16,0	55	0,30
AFH50926-020KR0,5	2,0	6	1,95	3,00	6,0	50	0,50
AFH50926-020LR0,5	2,0	6	1,95	3,00	10,0	55	0,50
AFH50926-020MR0,5	2,0	6	1,95	3,00	12,0	55	0,50
AFH50926-030AR0,2	3,0	6	2,85	4,00	8,0	55	0,20
AFH50926-030BR0,2	3,0	6	2,85	4,00	10,0	55	0,20
AFH50926-030CR0,2	3,0	6	2,85	4,00	12,0	55	0,20
AFH50926-030DR0,2	3,0	6	2,85	4,00	16,0	55	0,20

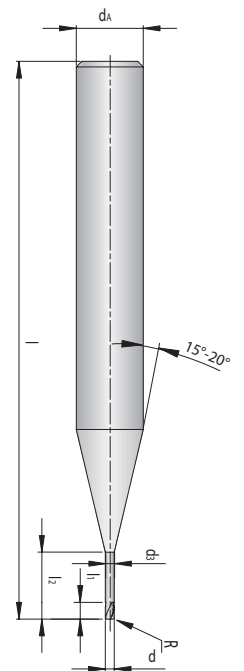

● = Hauptanwendung / Main application
○ = Nebenanwendung / Suitable

Alle Angaben in mm / Dimensions in mm

AFH50926-...R...

Schaft / Shank DIN 6535HA	d	d _A	d ₃	l ₁	l ₂	l	R
AFH50926-030ER0,3	3,0	6	2,85	4,00	8,0	55	0,30
AFH50926-030FR0,3	3,0	6	2,85	4,00	10,0	55	0,30
AFH50926-030GR0,3	3,0	6	2,85	4,00	12,0	55	0,30
AFH50926-030HR0,3	3,0	6	2,85	4,00	16,0	55	0,30
AFH50926-030JR0,5	3,0	6	2,85	4,00	10,0	55	0,50
AFH50926-030KR0,5	3,0	6	2,85	4,00	12,0	55	0,50
AFH50926-030LR0,5	3,0	6	2,85	4,00	16,0	55	0,50
AFH50926-030MR0,5	3,0	6	2,85	4,00	20,0	55	0,50
AFH50926-040AR0,2	4,0	6	3,85	5,00	12,0	55	0,20
AFH50926-040BR0,2	4,0	6	3,85	5,00	16,0	55	0,20
AFH50926-040CR0,2	4,0	6	3,85	5,00	20,0	55	0,20
AFH50926-040DR0,3	4,0	6	3,85	5,00	10,0	55	0,30
AFH50926-040ER0,3	4,0	6	3,85	5,00	12,0	55	0,30
AFH50926-040FR0,3	4,0	6	3,85	5,00	16,0	55	0,30
AFH50926-040GR0,3	4,0	6	3,85	5,00	20,0	55	0,30
AFH50926-040HR0,5	4,0	6	3,85	5,00	12,0	55	0,50
AFH50926-040JR0,5	4,0	6	3,85	5,00	16,0	55	0,50
AFH50926-040KR0,5	4,0	6	3,85	5,00	20,0	55	0,50
AFH50926-040LR1,0	4,0	6	3,85	5,00	12,0	55	1,00
AFH50926-040MR1,0	4,0	6	3,85	5,00	16,0	55	1,00
AFH50926-060AR0,3	6,0	6	5,85	7,00	20,0	60	0,30
AFH50926-060BR0,5	6,0	6	5,85	7,00	20,0	60	0,50
AFH50926-060CR1,0	6,0	6	5,85	7,00	20,0	60	1,00
AFH50926-060DR1,5	6,0	6	5,85	7,00	20,0	60	1,50
AFH50926-060ER2,0	6,0	6	5,85	7,00	20,0	60	2,00
AFH50926-080AR0,3	8,0	8	7,70	9,00	25,0	60	0,30
AFH50926-080BR0,5	8,0	8	7,70	9,00	25,0	60	0,50
AFH50926-080CR1,0	8,0	8	7,70	9,00	25,0	60	1,00
AFH50926-080DR1,5	8,0	8	7,70	9,00	25,0	60	1,50
AFH50926-080ER2,0	8,0	8	7,70	9,00	25,0	60	2,00
AFH50926-100AR0,3	10,0	10	9,70	11,00	32,0	70	0,30
AFH50926-100BR0,5	10,0	10	9,70	11,00	32,0	70	0,50
AFH50926-100CR1,0	10,0	10	9,70	11,00	32,0	70	1,00
AFH50926-100DR1,5	10,0	10	9,70	11,00	32,0	70	1,50
AFH50926-100ER2,0	10,0	10	9,70	11,00	32,0	70	2,00
AFH50926-120AR0,5	12,0	12	11,70	12,00	38,0	80	0,50
AFH50926-120BR1,0	12,0	12	11,70	12,00	38,0	80	1,00
AFH50926-120CR1,5	12,0	12	11,70	12,00	38,0	80	1,50
AFH50926-120DR2,0	12,0	12	11,70	12,00	38,0	80	2,00

Toleranz / Tolerance (µm)	Nennwertbereich / Diameter range (mm)	
	<6	>6
Fräser / Mill	0 -0,012	0 -0,015
Radius / Radius	0 -0,01	0 -0,015
Schaft / Shank	h6	h6

● = Hauptanwendung / Main application
○ = Nebenanwendung / Suitable

Alle Angaben in mm / Dimensions in mm



VHM-Radiusfräser

2 Schneiden

Solid carbide ball-nose end-mill

2 flutes

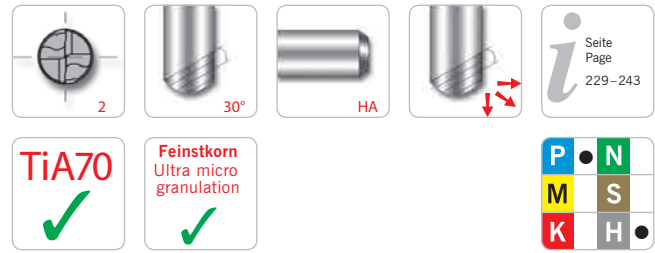

AFH51625-...

AFH

Schaft / Shank DIN 6535HA	d	d _A	d ₃	l ₁	l ₂	l	R
AFH51625-010	1,0	4	0,95	1,00	2,2	50	0,50
AFH51625-012	1,2	4	1,15	1,20	2,6	50	0,60
AFH51625-015	1,5	4	1,45	1,50	3,0	50	0,75
AFH51625-020	2,0	6	1,95	2,00	4,0	50	1,00
AFH51625-030	3,0	6	2,85	3,00	6,0	60	1,50
AFH51625-040	4,0	6	3,85	4,00	8,0	70	2,00
AFH51625-050	5,0	6	4,85	5,00	10,0	80	2,50
AFH51625-060	6,0	6	5,85	6,00	12,0	90	3,00
AFH51625-070	7,0	8	6,70	7,00	14,0	90	3,50
AFH51625-080	8,0	8	7,70	8,00	16,0	100	4,00
AFH51625-090	9,0	10	8,70	9,00	18,0	100	4,50
AFH51625-100	10,0	10	9,70	10,00	20,0	100	5,00
AFH51625-120	12,0	12	11,70	12,00	24,0	110	6,00
AFH51625-140	14,0	14	13,70	14,00	28,0	110	7,00
AFH51625-160	16,0	16	15,70	16,00	32,0	140	8,00
AFH51625-180	18,0	18	17,70	18,00	36,0	140	9,00
AFH51625-200	20,0	20	19,70	20,00	40,0	160	10,00
AFH51625-250	25,0	25	24,70	25,00	50,0	180	12,50

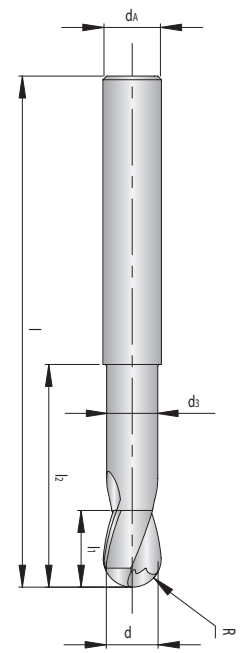

Toleranz / Tolerance	Nennwertbereich / Diameter range (mm)	
(μm)	<6	>6
Radius / Radius	0 -0,005	0 -0,01
Schaft / Shank	h6	h6

● = Hauptanwendung / Main application
○ = Nebenanwendung / Suitable

Alle Angaben in mm / Dimensions in mm

VHM-Radiusfräser

2 Schneiden

Solid carbide ball-nose end-mill

2 flutes

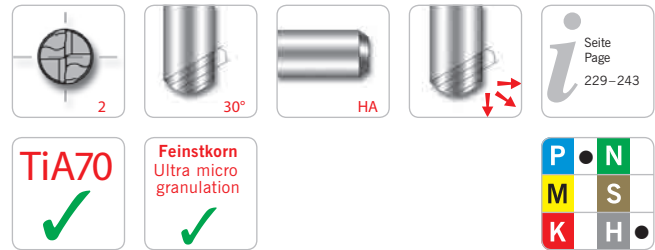
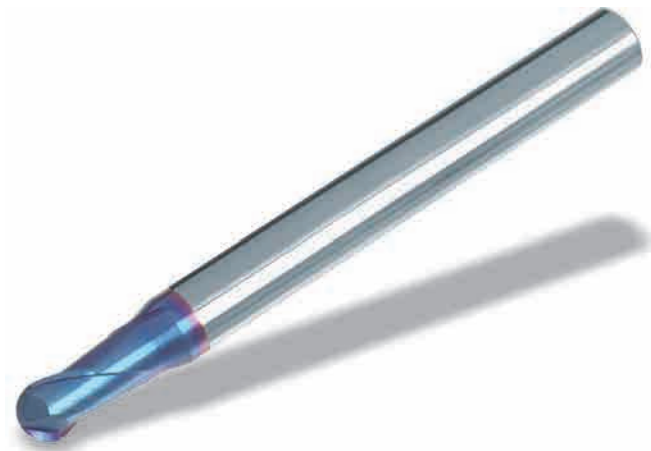

AFH51626-...

Schaft / Shank DIN 6535HA	d	d _A	d ₃	l ₁	l ₂	l	R
AFH51626-001	0,1	4	-	0,20	-	40	0,05
AFH51626-002	0,2	4	-	0,30	-	40	0,10
AFH51626-003	0,3	4	-	0,50	-	40	0,15
AFH51626-004	0,4	4	-	0,60	-	40	0,20
AFH51626-005	0,5	4	-	0,70	-	40	0,25
AFH51626-006	0,6	4	-	0,90	-	40	0,30
AFH51626-007	0,7	4	-	1,10	-	40	0,35
AFH51626-008	0,8	4	-	1,20	-	40	0,40
AFH51626-009	0,9	4	-	1,40	-	40	0,45
AFH51626-010	1,0	6	0,95	1,50	3,0	50	0,50
AFH51626-015	1,5	6	1,45	2,00	4,0	50	0,75
AFH51626-020	2,0	6	1,95	2,50	5,0	50	1,00
AFH51626-025	2,5	6	2,40	3,00	7,0	50	1,25
AFH51626-030	3,0	6	2,85	4,00	10,0	60	1,50
AFH51626-035	3,5	6	3,35	4,50	10,0	60	1,75
AFH51626-040	4,0	6	3,85	5,00	10,0	60	2,00
AFH51626-045	4,5	6	4,35	5,50	10,0	60	2,25
AFH51626-050	5,0	6	4,85	6,00	12,0	60	2,50
AFH51626-055	5,5	6	5,35	6,50	12,0	60	2,75
AFH51626-060A	6,0	6	5,85	7,00	15,0	60	3,00
AFH51626-060B	6,0	6	5,85	9,00	30,0	90	3,00
AFH51626-080A	8,0	8	7,70	9,00	15,0	60	4,00
AFH51626-080B	8,0	8	7,70	9,00	15,0	80	4,00
AFH51626-080C	8,0	8	7,70	12,00	30,0	100	4,00
AFH51626-100A	10,0	10	9,70	11,00	25,0	60	5,00
AFH51626-100B	10,0	10	9,70	11,00	25,0	80	5,00
AFH51626-100C	10,0	10	9,70	15,00	30,0	100	5,00
AFH51626-120	12,0	12	11,70	14,00	25,0	80	6,00

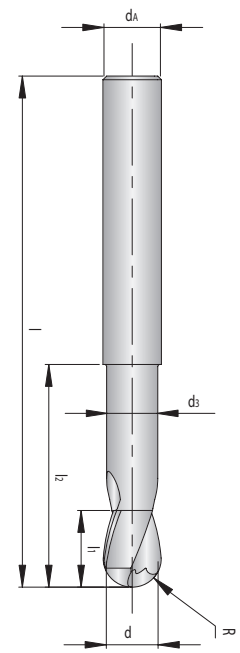

AFH

Toleranz / Tolerance	Nennwertbereich / Diameter range (mm)	
(μm)	<6	>6
Radius / Radius	0 -0,005	0 -0,01
Schaft / Shank	h6	h6

● = Hauptanwendung / Main application
○ = Nebenanwendung / Suitable

Alle Angaben in mm / Dimensions in mm

VHM-Radiusfräser

3 Schneiden

Solid carbide ball-nose end-mill

3 flutes

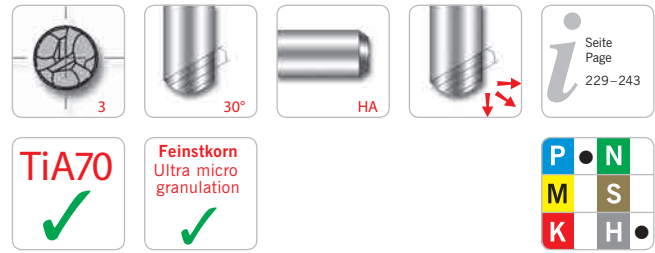

AFH51635-...

AFH

Schaft / Shank DIN 6535HA	d	d _A	l ₁	l	R
AFH51635-030	3,0	6	8,00	60	1,50
AFH51635-040	4,0	6	8,00	70	2,00
AFH51635-050	5,0	6	10,00	80	2,50
AFH51635-060	6,0	6	12,00	90	3,00
AFH51635-080	8,0	8	14,00	100	4,00
AFH51635-100	10,0	10	18,00	100	5,00
AFH51635-120	12,0	12	22,00	110	6,00
AFH51635-160	16,0	16	30,00	140	8,00
AFH51635-200	20,0	20	38,00	160	10,00

Toleranz / Tolerance (μm)	Nennwertbereich / Diameter range (mm)	
	<6	>6
Radius / Radius	±0,005	±0,01
Schaft / Shank	h6	h6

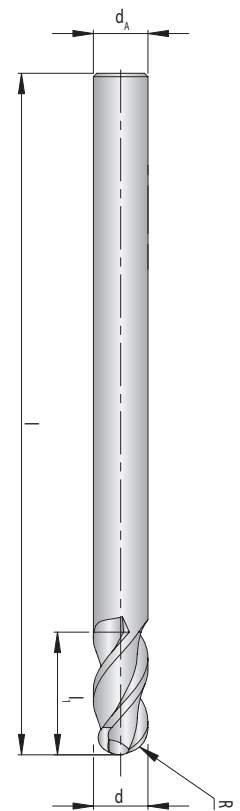

● = Hauptanwendung / Main application
○ = Nebenanwendung / Suitable

Alle Angaben in mm / Dimensions in mm

VHM-Schaftfräser

4 Schneiden

Solid carbide end-mill

4 flutes

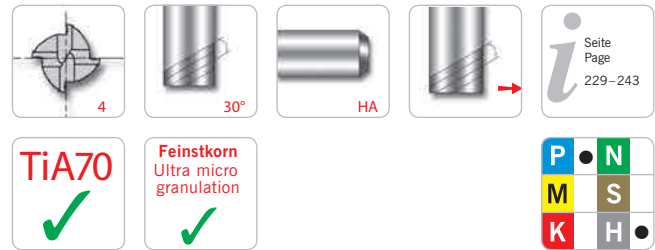
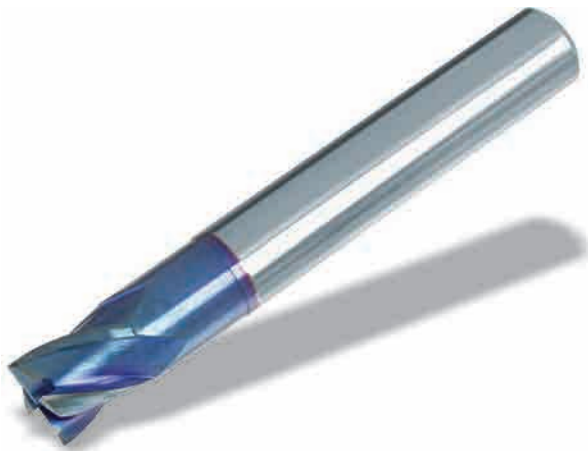

AFH50140-...

Schaft / Shank DIN 6535HA	d	d _A	d ₃	l ₁	l ₂	l
AFH50140-010	1,0	6	0,95	1,50	3,0	50
AFH50140-020	2,0	6	1,95	2,00	5,0	50
AFH50140-030	3,0	6	2,85	3,00	8,0	55
AFH50140-040	4,0	6	3,85	4,00	10,0	55
AFH50140-050	5,0	6	4,85	5,00	13,0	55
AFH50140-060	6,0	6	5,85	6,00	15,0	55
AFH50140-080	8,0	8	7,70	8,00	20,0	65
AFH50140-100	10,0	10	9,70	10,00	25,0	75
AFH50140-120	12,0	12	11,70	12,00	28,0	85
AFH50140-160	16,0	16	15,70	16,00	32,0	90
AFH50140-200	20,0	20	19,70	20,00	40,0	105

Toleranz / Tolerance (μm)	Nennwertbereich / Diameter range (mm)	
	<6	>6
Fräser / Mill	0 -0,012	0 -0,016
Schaft / Shank	h6	h6

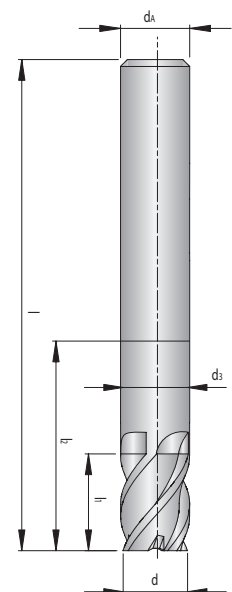

AFH

● = Hauptanwendung / Main application
○ = Nebenanwendung / Suitable

Alle Angaben in mm / Dimensions in mm

VHM-Schaftfräser

4 Schneiden, mit Eckenradius



Solid carbide end-mill

4 flutes, with corner radius

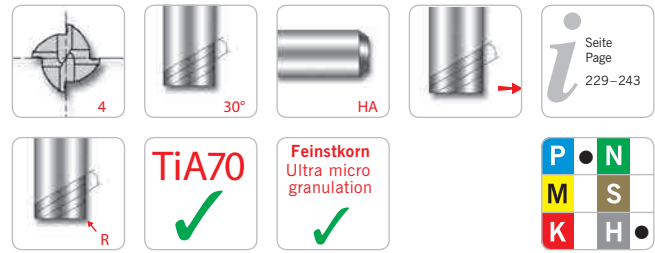

AFH50142-...R...

Schaft / Shank DIN 6535HA	d	d _A	d ₃	l ₁	l ₂	l	R
AFH50142-060R0,5	6,0	6	5,85	9,00	20,0	90	0,50
AFH50142-060R1,0	6,0	6	5,85	9,00	20,0	90	1,00
AFH50142-080R0,5	8,0	8	7,70	12,00	25,0	100	0,50
AFH50142-080R1,0	8,0	8	7,70	12,00	25,0	100	1,00
AFH50142-100R0,5	10,0	10	9,70	15,00	32,0	100	0,50
AFH50142-100R1,0	10,0	10	9,70	15,00	32,0	100	1,00
AFH50142-100R2,0	10,0	10	9,70	15,00	32,0	100	2,00
AFH50142-120R0,5	12,0	12	11,70	18,00	38,0	110	0,50
AFH50142-120R1,0	12,0	12	11,70	18,00	38,0	110	1,00
AFH50142-120R2,0	12,0	12	11,70	18,00	38,0	110	2,00

Toleranz / Tolerance (μm)	Nennwertbereich / Diameter range (mm)	
	<6	>6
Fräser / Mill	0	0
	-0,012	-0,015
Radius / Radius	±0,01	±0,015
Schaft / Shank	h6	h6

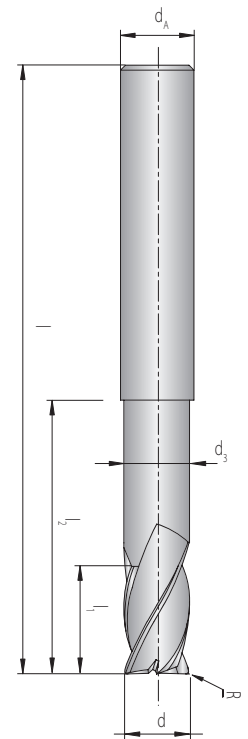

AFH

VHM-Schaftfräser

4 Schneiden, mit Eckenradius



Solid carbide end-mill

4 flutes, with corner radius

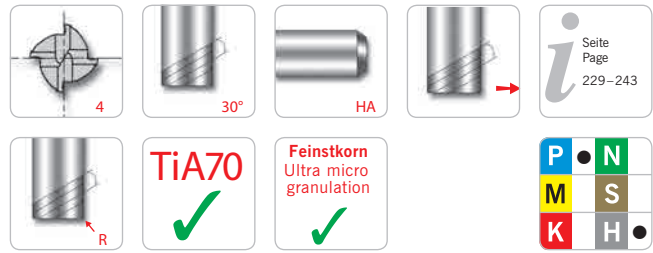

AFH50146-...R...

Schaft / Shank DIN 6535HA	d	d _A	d ₃	l ₁	l ₂	l	R
AFH50146-030AR0,3	3,0	6	2,85	4,00	12,0	55	0,30
AFH50146-030BR0,3	3,0	6	2,85	4,00	16,0	55	0,30
AFH50146-030CR0,3	3,0	6	2,85	4,00	20,0	55	0,30
AFH50146-030DR0,5	3,0	6	2,85	4,00	10,0	55	0,50
AFH50146-030ER0,5	3,0	6	2,85	4,00	16,0	55	0,50
AFH50146-030FR0,5	3,0	6	2,85	4,00	20,0	55	0,50
AFH50146-040AR0,3	4,0	6	3,85	5,00	12,0	55	0,30
AFH50146-040BR0,3	4,0	6	3,85	5,00	16,0	55	0,30
AFH50146-040CR0,3	4,0	6	3,85	5,00	20,0	55	0,30
AFH50146-040DR0,5	4,0	6	3,85	5,00	12,0	55	0,50
AFH50146-040ER0,5	4,0	6	3,85	5,00	16,0	55	0,50
AFH50146-040FR0,5	4,0	6	3,85	5,00	20,0	55	0,50
AFH50146-040GR1,0	4,0	6	3,85	5,00	12,0	55	1,00
AFH50146-060AR0,5	6,0	6	5,85	7,00	20,0	60	0,50
AFH50146-060BR1,0	6,0	6	5,85	7,00	20,0	60	1,00
AFH50146-060CR1,5	6,0	6	5,85	7,00	20,0	60	1,50
AFH50146-080AR0,5	8,0	8	7,70	9,00	25,0	60	0,50
AFH50146-080BR1,0	8,0	8	7,70	9,00	25,0	60	1,00
AFH50146-080CR1,5	8,0	8	7,70	9,00	25,0	60	1,50
AFH50146-080DR2,0	8,0	8	7,70	9,00	25,0	60	2,00
AFH50146-100AR0,5	10,0	10	9,70	11,00	32,0	70	0,50
AFH50146-100BR1,0	10,0	10	9,70	11,00	32,0	70	1,00
AFH50146-100CR1,5	10,0	10	9,70	11,00	32,0	70	1,50
AFH50146-100DR2,0	10,0	10	9,70	11,00	32,0	70	2,00
AFH50146-120AR0,5	12,0	12	11,70	12,00	38,0	80	0,50
AFH50146-120BR1,0	12,0	12	11,70	12,00	38,0	80	1,00
AFH50146-120CR1,5	12,0	12	11,70	12,00	38,0	80	1,50
AFH50146-120DR2,0	12,0	12	11,70	12,00	38,0	80	2,00

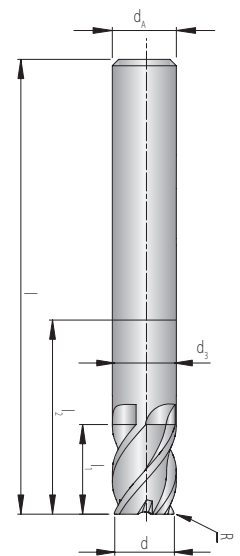

AFH

Toleranz / Tolerance (μm)	Nennwertbereich / Diameter range (mm)	
	<6	>6
Fräser / Mill	0 -0,012	0 -0,015
Radius / Radius	±0,01	±0,015
Schaft / Shank	h6	h6

● = Hauptanwendung / Main application
○ = Nebenanwendung / Suitable

Alle Angaben in mm / Dimensions in mm

VHM-Schaftfräser

4 Schneiden, mit Eckenradius



Solid carbide end-mill

4 flutes, with corner radius

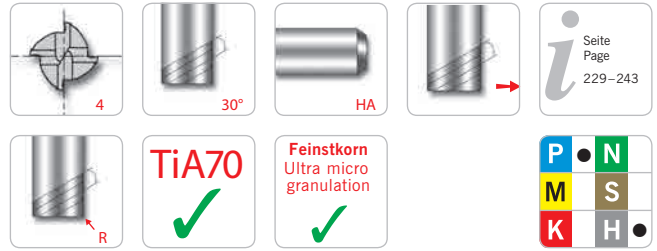

AFH50745-...R...

AFH

Schaft / Shank DIN 6535HA	d	d _A	d ₃	l ₁	l ₂	l	R
AFH50745-010R0,1	1,0	6	-	1,50	-	40	0,10
AFH50745-015R0,1	1,5	6	-	2,20	-	40	0,10
AFH50745-020R0,1	2,0	6	1,95	3,00	6,0	40	0,10
AFH50745-025R0,1	2,5	6	2,40	4,00	6,0	40	0,10
AFH50745-030R0,1	3,0	6	2,85	4,00	7,0	45	0,10
AFH50745-035R0,1	3,5	6	3,35	5,00	9,0	45	0,10
AFH50745-040R0,1	4,0	6	3,85	5,00	9,0	45	0,10
AFH50745-045R0,1	4,5	6	4,35	6,00	10,0	45	0,10
AFH50745-050R0,2	5,0	6	4,85	6,00	11,0	50	0,20
AFH50745-060R0,2	6,0	6	5,85	7,00	14,0	50	0,20
AFH50745-080R0,2	8,0	8	7,70	9,00	18,0	60	0,20
AFH50745-100R0,2	10,0	10	9,70	12,00	25,0	75	0,20
AFH50745-120R0,3	12,0	12	11,70	15,00	30,0	75	0,30
AFH50745-160R0,3	16,0	16	15,70	18,00	38,0	90	0,30
AFH50745-200R0,3	20,0	20	19,70	24,00	45,0	100	0,30

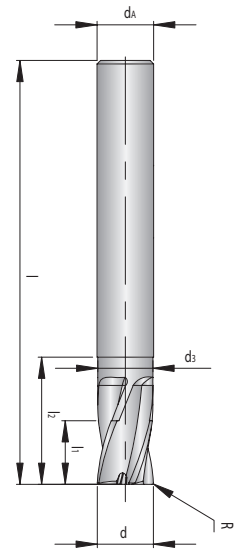

Toleranz / Tolerance (μm)	Nennwertbereich / Diameter range (mm)	
	<6	>6
Fräser / Mill	0 -0,012	0 -0,015
Radius / Radius	0 -0,01	0 -0,015
Schaft / Shank	h6	h6

● = Hauptanwendung / Main application
○ = Nebenanwendung / Suitable

Alle Angaben in mm / Dimensions in mm

VHM-Radiusfräser

4 Schneiden

Solid carbide ball-nose end-mill

4 flutes

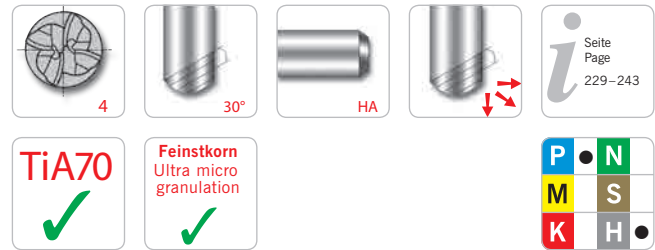

Seite
Page
229-243

AFH50341-...

Schaft / Shank DIN 6535HA	d	d _A	l ₁	l	R
AFH50341-030	3,0	6	8,00	60	1,50
AFH50341-040	4,0	6	8,00	70	2,00
AFH50341-050	5,0	6	10,00	80	2,50
AFH50341-060	6,0	6	12,00	90	3,00
AFH50341-080	8,0	8	14,00	100	4,00
AFH50341-100	10,0	10	18,00	100	5,00
AFH50341-120	12,0	12	22,00	110	6,00
AFH50341-160	16,0	16	30,00	140	8,00
AFH50341-200	20,0	20	38,00	160	10,00

Toleranz / Tolerance (μm)	Nennwertbereich / Diameter range (mm)	
	<6	>6
Fräser / Mill	0 -0,012	0 -0,015
Radius / Radius	±0,005	±0,010
Schaft / Shank	h6	h6

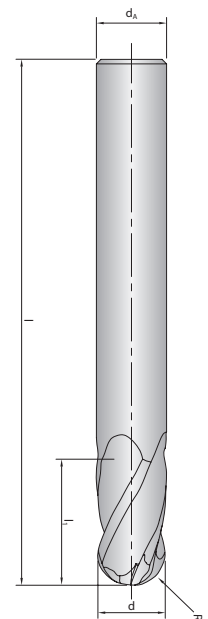

AFH

● = Hauptanwendung / Main application
○ = Nebenanwendung / Suitable

Alle Angaben in mm / Dimensions in mm

VHM-Schaftfräser

6 Schneiden, mit Eckenradius



Solid carbide end-mill

6 flutes, with corner radius

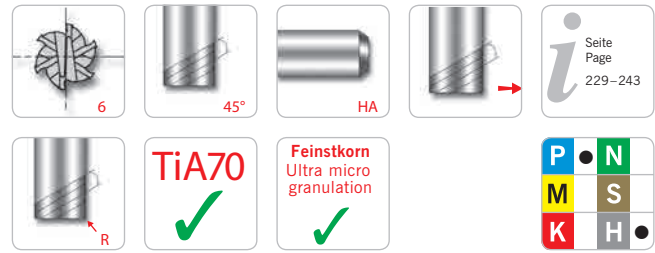

AFH50865-...R...

AFH

Schaft / Shank DIN 6535HA	d	d _A	d ₃	l ₁	l ₂	l	R
AFH50865-060AR0,25	6,0	6	5,85	6,00	14,0	50	0,25
AFH50865-060BR0,5	6,0	6	5,85	6,00	14,0	50	0,50
AFH50865-060CR0,5	6,0	6	-	13,00	-	70	0,50
AFH50865-060DR0,5*	6,0	6	-	26,00	-	70	0,50
AFH50865-080AR0,5	8,0	8	7,70	8,00	24,0	60	0,50
AFH50865-080BR0,5	8,0	8	-	19,00	-	90	0,50
AFH50865-080CR0,5*	8,0	8	-	36,00	-	90	0,50
AFH50865-100AR0,5	10,0	10	-	22,00	-	100	0,50
AFH50865-100BR1,0	10,0	10	9,70	10,00	30,0	70	1,00
AFH50865-100CR1,0	10,0	10	-	22,00	-	100	1,00
AFH50865-100DR1,0*	10,0	10	-	46,00	-	100	1,00
AFH50865-120AR0,5	12,0	12	-	26,00	-	110	0,50
AFH50865-120BR1,0	12,0	12	11,70	12,00	30,0	75	1,00
AFH50865-120CR1,0	12,0	12	-	26,00	-	110	1,00
AFH50865-120DR1,0*	12,0	12	-	56,00	-	110	1,00
AFH50865-160AR1,0	16,0	16	-	32,00	-	130	1,00
AFH50865-160BR1,5	16,0	16	-	32,00	-	130	1,50
AFH50865-160CR1,5*	16,0	16	-	66,00	-	130	1,50
AFH50865-200AR1,0	20,0	20	-	38,00	-	140	1,00
AFH50865-200BR1,5	20,0	20	-	38,00	-	140	1,50
AFH50865-200CR2,0*	20,0	20	-	38,00	-	140	2,00
AFH50865-200DR2,0	20,0	20	-	76,00	-	140	2,00

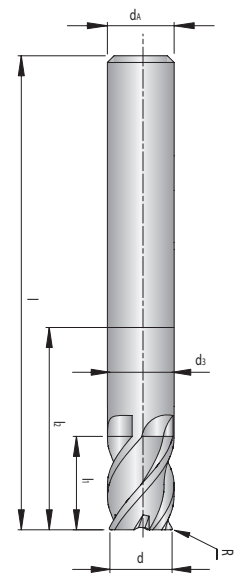

Toleranz / Tolerance (µm)	Nennwertbereich / Diameter range (mm)	
	<6	>6
Fräser / Mill	-0,02 – *-0,03	-0,02 – *-0,03
Radius / Radius	±0,01	±0,015
Schaft / Shank	h6	h6

● = Hauptanwendung / Main application
○ = Nebenanwendung / Suitable

Alle Angaben in mm / Dimensions in mm

VHM-Schaftfräser

6-8 Schneiden, lange Ausführung



Solid carbide end-mill

6-8 flutes, long design

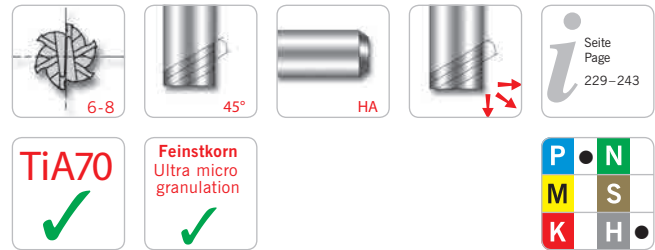

AFH508.1-....

Schaft / Shank DIN 6535HA	d	d _A	l ₁	l	z
AFH50861-060	6,0	6	13,00	57	6
AFH50861-080	8,0	8	19,00	63	6
AFH50861-100	10,0	10	22,00	72	6
AFH50861-120	12,0	12	26,00	83	6
AFH50861-140	14,0	14	26,00	83	6
AFH50861-160	16,0	16	32,00	92	6
AFH50881-180	18,0	18	32,00	92	8
AFH50881-200	20,0	20	38,00	104	8
AFH50881-250	25,0	25	44,00	104	8

Toleranz / Tolerance

Fräser / Mill	0 -0,02
Schaft / Shank	h6

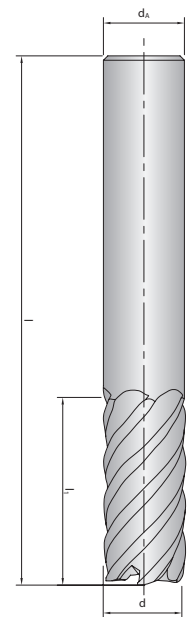

AFH

● = Hauptanwendung / Main application
○ = Nebenanwendung / Suitable

Alle Angaben in mm / Dimensions in mm

VHM-Schaftfräser

6-8 Schneiden, extra lange Ausführung

Solid carbide end-mill

6-8 flutes, extra long design

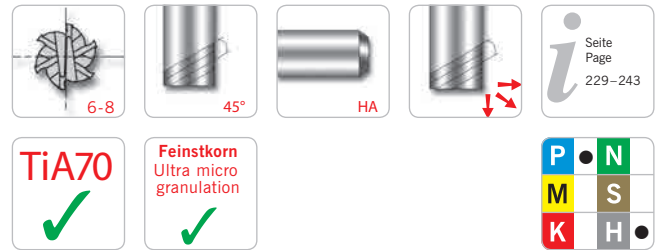
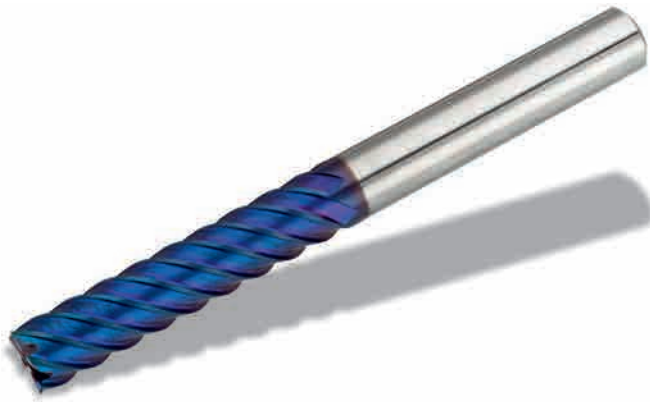

Seite
Page
229-243



AFH508.2-...

Schaft / Shank DIN 6535HA	d	d _A	l ₁	l	z
AFH50862-060	6,0	6	26,00	70	6
AFH50862-080	8,0	8	36,00	90	6
AFH50862-100	10,0	10	46,00	100	6
AFH50862-120	12,0	12	56,00	110	6
AFH50862-160	16,0	16	66,00	130	6
AFH50882-200	20,0	20	76,00	140	8
AFH50882-200	25,0	25	92,00	180	8

Toleranz / Tolerance

Fräser / Mill	0 -0,03
Schaft / Shank	h6

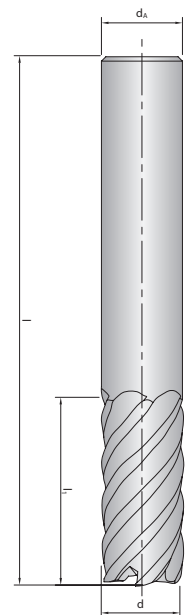

AFH

VHM-Torus-Schaftfräser / Hochvorschubfräser

4 Schneiden, kurze Ausführung, mit Eckenradius



Solid carbide high-feed end-mill

4 flutes, short design, with corner radius

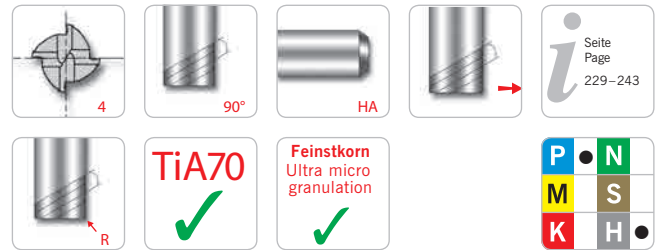

AFH50746-...R...

Schaft / Shank DIN 6535HA	d	d _A	d ₃	l ₁	l ₂	l	R
AFH50746-020 R0.5	2,0	6	1,80	1,00	6,0	50	0,50
AFH50746-030 R0.5	3,0	6	2,80	1,20	8,0	50	0,50
AFH50746-040 R0.5	4,0	6	3,80	1,50	10,0	50	0,50
AFH50746-060 R0.5	6,0	6	5,40	2,50	12,0	60	0,50
AFH50746-060 R1.0	6,0	6	5,40	2,50	12,0	60	1,00
AFH50746-080 R1.0	8,0	8	7,20	3,50	16,0	60	1,00
AFH50746-080 R2.0	8,0	8	7,20	3,50	16,0	60	2,00
AFH50746-100 R1.0	10,0	10	9,00	4,00	20,0	70	1,00
AFH50746-100 R2.0	10,0	10	9,00	4,00	20,0	70	2,00
AFH50746-120 R2.0	12,0	12	11,00	5,00	25,0	80	2,00
AFH50746-120 R3.0	12,0	12	11,00	5,00	25,0	80	3,00

Toleranz / Tolerance	
Fräser / Mill	0 -0,02
Radius / Radius	± 0,005
Schaft / Shank	h6

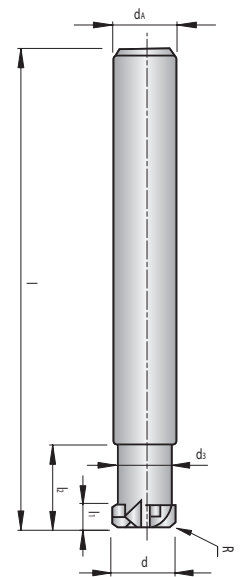

AFH

● = Hauptanwendung / Main application
○ = Nebenanwendung / Suitable

Alle Angaben in mm / Dimensions in mm

VHM-Torus-Schaftfräser / Hochvorschubfräser

4 Schneiden, lange Ausführung, mit Eckenradius



Solid carbide high-feed end-mill

4 flutes, long design, with corner radius

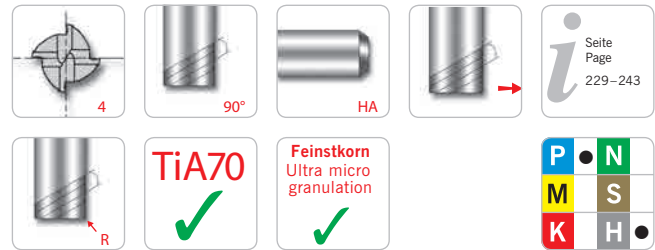

AFH50741-...R...

Schaft / Shank DIN 6535HA	d	d _A	d ₃	l ₁	l ₂	l	R
AFH50741-020 R0.5	2,0	6	1,80	1,00	6,0	70	0,50
AFH50741-030 R0.5	3,0	6	2,80	1,20	8,0	70	0,50
AFH50741-040 R0.5	4,0	6	3,80	1,50	10,0	70	0,50
AFH50741-050 R0.5	5,0	6	4,60	2,00	10,0	70	0,50
AFH50741-060 R0.5	6,0	6	5,40	2,50	12,0	90	0,50
AFH50741-060 R1.0	6,0	6	5,40	2,50	12,0	90	1,00
AFH50741-080 R1.0	8,0	8	7,20	3,50	16,0	100	1,00
AFH50741-080 R2.0	8,0	8	7,20	3,50	16,0	100	2,00
AFH50741-100 R1.0	10,0	10	9,00	4,00	20,0	100	1,00
AFH50741-100 R2.0	10,0	10	9,00	4,00	20,0	100	2,00
AFH50741-120 R2.0	12,0	12	11,00	5,00	25,0	110	2,00
AFH50741-120 R3.0	12,0	12	11,00	5,00	25,0	110	3,00
AFH50741-160 R3.0	16,0	16	15,00	6,50	30,0	130	3,00

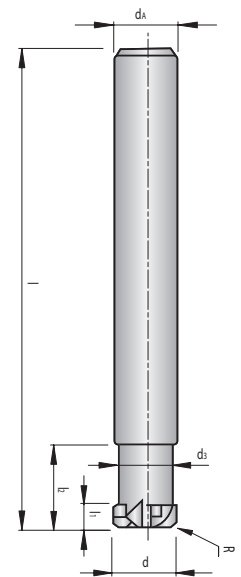

Toleranz / Tolerance	
Fräser / Mill	0
	-0,02
Radius / Radius	± 0,005
Schaft / Shank	h6

AFH

Empfohlene Schnittwerte VHM-Schaftfräser

Recommended cutting data Solid carbide end-mill

Ausführung AFH → Ø 0,1 mm – D 4,0 mm MINI Z2

Design AFH → Ø 0,1 mm – D 4,0 mm MINI Z2

Fräser End-mill	Stahl / Steel							Stahl / Steel				Stahl / Steel				Stahl gehärtet / hardened steel				Stahl gehärtet / hardened steel			
	≤ 800 N/mm ² (≥ 22 HRC)							≤ 1100 N/mm ² (25-35 HRC)				≤ 1400 N/mm ² (35-45 HRC)				≤ 1950 N/mm ² (45-55 HRC)				≥ 2000 N/mm ² (55-70 HRC)			
	D [mm]	R [mm]	l _c [mm]	a _p [mm]	n [mm]	f _z [mm]	v _f [mm/min]	a _p [mm]	n [mm]	f _z [mm]	v _f [mm/min]	a _p [mm]	n [mm]	f _z [mm]	v _f [mm/min]	a _p [mm]	n [mm]	f _z [mm]	v _f [mm/min]	a _p [mm]	n [mm]	f _z [mm]	v _f [mm/min]
0,10	-	0,15	0,006	50000	0,011	1050	0,005	50000	0,011	1050	0,004	50000	0,008	780	0,003	45000	0,007	594	0,002	42000	0,006	479	
0,10	-	0,20	0,006	50000	0,011	1050	0,005	50000	0,011	1050	0,004	50000	0,008	780	0,003	45000	0,007	594	0,002	42000	0,006	479	
0,20	-	0,30	0,020	45000	0,016	1418	0,018	40500	0,016	1276	0,014	38250	0,012	895	0,010	33750	0,010	668	0,008	31500	0,009	539	
0,20	-	0,40	0,020	45000	0,016	1418	0,018	40500	0,016	1276	0,014	38250	0,012	895	0,010	33750	0,010	668	0,008	31500	0,009	539	
0,30	-	0,45	0,021	40000	0,016	1260	0,019	36000	0,016	1134	0,015	34000	0,012	796	0,011	30000	0,010	594	0,008	28000	0,009	479	
0,30	-	0,60	0,021	40000	0,016	1260	0,019	36000	0,016	1134	0,015	34000	0,012	796	0,011	30000	0,010	594	0,008	28000	0,009	479	
0,40	-	0,60	0,040	32000	0,021	1344	0,036	28800	0,021	1210	0,028	27200	0,016	849	0,020	24000	0,013	634	0,016	22400	0,011	511	
0,40	-	0,80	0,040	32000	0,021	1344	0,036	28800	0,021	1210	0,028	27200	0,016	849	0,020	24000	0,013	634	0,016	22400	0,011	511	
0,50	-	0,70	0,050	32000	0,021	1344	0,045	28800	0,021	1210	0,035	27200	0,016	849	0,025	24000	0,013	634	0,020	22400	0,011	511	
0,50	0,05	0,70	0,050	32000	0,021	1344	0,045	28800	0,021	1210	0,035	27200	0,016	849	0,025	24000	0,013	634	0,020	22400	0,011	511	
0,50	-	1,00	0,050	32000	0,021	1344	0,045	28800	0,021	1210	0,035	27200	0,016	849	0,025	24000	0,013	634	0,020	22400	0,011	511	
0,50	0,05	1,00	0,050	32000	0,021	1344	0,045	28800	0,021	1210	0,035	27200	0,016	849	0,025	24000	0,013	634	0,020	22400	0,011	511	
0,60	-	0,90	0,042	32000	0,026	1680	0,038	28800	0,026	1512	0,029	27200	0,020	1061	0,021	24000	0,017	792	0,017	22400	0,014	638	
0,60	0,05	0,90	0,042	32000	0,026	1680	0,038	28800	0,026	1512	0,029	27200	0,020	1061	0,021	24000	0,017	792	0,017	22400	0,014	638	
0,60	-	1,20	0,042	32000	0,026	1680	0,038	28800	0,026	1512	0,029	27200	0,020	1061	0,021	24000	0,017	792	0,017	22400	0,014	638	
0,60	0,05	1,20	0,042	32000	0,026	1680	0,038	28800	0,026	1512	0,029	27200	0,020	1061	0,021	24000	0,017	792	0,017	22400	0,014	638	
0,70	-	1,40	0,049	28800	0,024	1382	0,044	25920	0,024	1244	0,034	24480	0,020	955	0,025	21600	0,017	713	0,020	20160	0,014	575	
0,70	0,05	1,40	0,049	28800	0,024	1382	0,044	25920	0,024	1244	0,034	24480	0,020	955	0,025	21600	0,017	713	0,020	20160	0,014	575	
0,70	0,10	1,00	0,049	28800	0,024	1382	0,044	25920	0,024	1244	0,034	24480	0,020	955	0,025	21600	0,017	713	0,020	20160	0,014	575	
0,80	-	1,20	0,056	32000	0,026	1680	0,050	28800	0,026	1512	0,039	27200	0,020	1061	0,028	24000	0,017	792	0,022	22400	0,014	638	
0,80	0,05	1,20	0,056	32000	0,026	1680	0,050	28800	0,026	1512	0,039	27200	0,020	1061	0,028	24000	0,017	792	0,022	22400	0,014	638	
0,80	-	1,60	0,056	32000	0,026	1680	0,050	28800	0,026	1512	0,039	27200	0,020	1061	0,028	24000	0,017	792	0,022	22400	0,014	638	
0,80	0,05	1,60	0,056	32000	0,026	1680	0,050	28800	0,026	1512	0,039	27200	0,020	1061	0,028	24000	0,017	792	0,022	22400	0,014	638	
0,80	0,10	1,20	0,056	32000	0,026	1680	0,050	28800	0,026	1512	0,039	27200	0,020	1061	0,028	24000	0,017	792	0,022	22400	0,014	638	
0,90	-	2,00	0,036	28800	0,024	1382	0,032	25920	0,024	1244	0,025	24480	0,020	955	0,018	21600	0,017	713	0,014	20160	0,014	575	
0,90	0,05	2,00	0,036	28800	0,024	1382	0,032	25920	0,024	1244	0,025	24480	0,020	955	0,018	21600	0,017	713	0,014	20160	0,014	575	
1,00	-	1,50	0,010	28800	0,032	1814	0,090	25920	0,032	1633	0,070	24480	0,023	1146	0,050	21600	0,020	855	0,040	20160	0,017	689	
1,00	0,10	1,50	0,010	28800	0,032	1814	0,090	25920	0,032	1633	0,070	24480	0,023	1146	0,050	21600	0,020	855	0,040	20160	0,017	689	
1,00	0,10	1,80	0,010	28800	0,032	1814	0,090	25920	0,032	1633	0,070	24480	0,023	1146	0,050	21600	0,020	855	0,040	20160	0,017	689	
1,20	0,10	1,80	0,084	25600	0,032	1613	0,076	23040	0,032	1452	0,059	21760	0,023	1018	0,042	19200	0,020	760	0,034	17920	0,017	613	
1,50	-	1,70	0,110	22400	0,032	1411	0,099	20160	0,032	1270	0,077	19040	0,023	891	0,055	16800	0,020	665	0,044	15680	0,017	536	
1,50	-	2,30	0,110	22400	0,032	1411	0,099	20160	0,032	1270	0,077	19040	0,023	891	0,055	16800	0,020	665	0,044	15680	0,017	536	
1,50	0,10	2,20	0,110	22400	0,032	1411	0,099	20160	0,032	1270	0,077	19040	0,023	891	0,055	16800	0,020	665	0,044	15680	0,017	536	
1,50	0,15	2,20	0,110	22400	0,032	1411	0,099	20160	0,032	1270	0,077	19040	0,023	891	0,055	16800	0,020	665	0,044	15680	0,017	536	
1,50	0,20	2,50	0,110	22400	0,032	1411	0,099	20160	0,032	1270	0,077	19040	0,023	891	0,055	16800	0,020	665	0,044	15680	0,017	536	
2,00	-	2,00	0,200	16800	0,042	1411	0,180	15120	0,042	1270	0,140	14280	0,031	891	0,100	12600	0,026	665	0,080	11760	0,023	536	
2,00	-	3,00	0,200	16800	0,042	1411	0,180	15120	0,042	1270	0,140	14280	0,031	891	0,100	12600	0,026	665	0,080	11760	0,023	536	
2,00	0,10	3,00	0,200	16800	0,042	1411	0,180	15120	0,042	1270	0,140	14280	0,031	891	0,100	12600	0,026	665	0,080	11760	0,023	536	
2,00	0,15	2,20	0,200	16800	0,042	1411	0,180	15120	0,042	1270	0,140	14280	0,031	891	0,100	12600	0,026	665	0,080	11760	0,023	536	
2,00	0,20	3,00	0,200	16800	0,042	1411	0,180	15120	0,042	1270	0,140	14280	0,031	891	0,100	12600	0,026	665	0,080	11760	0,023	536	
2,00	0,30	3,00	0,200	16800	0,042	1411	0,180	15120	0,042	1270	0,140	14280	0,031	891	0,100	12600	0,026	665	0,080	11760	0,023	536	
2,00	0,50	3,00	0,200	16800	0,042	1411	0,180	15120	0,042	1270	0,140	14280	0,031	891	0,100	12600	0,026	665	0,080	11760	0,023	536	
2,50	-	2,50	0,180	14400	0,053	1512	0,162	12960	0,053	1361	0,126	12240	0,039	955	0,090	10800	0,033	713	0,072	10080	0,029	575	
2,50	0,10	4,00	0,180	14400	0,053	1512	0,162	12960	0,053	1361	0,126	12240	0,039	955	0,090	10800	0,033	713	0,072	10080	0,029	575	
3,00	-	3,00	0,300	12800	0,053	1344	0,270	11520	0,053	1210	0,210	10880	0,039	849	0,150	9600	0,033	634	0,120	8960	0,029	511	
3,00	-	4,50	0,300	12800	0,053	1344	0,270	11520	0,053	1210	0,210	10880	0,039	849	0,150	9600	0,033	634	0,120	8960	0,029	511	
3,00	0,10	4,00	0,300	12800	0,053	1344	0,270	11520	0,053	1210	0,210	10880	0,039	849	0,150	9600	0,033	634	0,120	8960	0,029	511	
3,00	0,30	4,00	0,300	12800	0,053	1344	0,270	11520	0,053	1210	0,210	10880	0,039	849	0,150	9600	0,033	634	0,120	8960	0,029	511	
3,00	0,50	4,00	0,300	12800	0,053	1344	0,270	11520	0,053	1210	0,210	10880	0,039	849	0,150	9600	0,033	634	0,120	8960	0,029	511	
3,50	-	3,50	0,350	11175	0,060	1340	0,310	1057	0,060	1207	0,250	9500	0,044	846	0,180	8380	0,038	632	0,140	7800	0,032	510	
3,50	0,10	5,00	0,350	11175	0,060	1340	0,310	1057	0,060	1207	0,250	9500	0,044	846	0,180	8380	0,038	632	0,140	7800	0,032	510	
4,00	-	4,00	0,400	9550	0,070	1337	0,360	8595	0,070	1203	0,280	8118	0,052	844	0,200	7163	0,044	630	0,160	6685	0,0		

Umfangfräsen / Contour milling

55–70 HRC

Ø	Gehärteter Stahl / hardened steel (≤ 55 HRC)			Gehärteter Stahl / hardened steel (55–62 HRC)			Gehärteter Stahl / hardened steel (62–70 HRC)		
	D [mm]	n [min ⁻¹]	v _f [mm/min]	a _e [mm]	n [min ⁻¹]	v _f [mm/min]	a _e [mm]	n [min ⁻¹]	v _f [mm/min]
1,0	40000	1200	0,05	40000	800	0,03	32000	500	0,02
2,0	40000	2000	0,10	24000	1000	0,05	16000	600	0,05
3,0	32000	3800	0,20	16000	1900	0,10	11000	1200	0,05
4,0	24000	4400	0,20	12000	2200	0,10	8000	1300	0,05
6,0	16000	5800	0,30	8000	2900	0,20	5300	1800	0,10
8,0	12000	5800	0,40	6000	2900	0,20	4000	1800	0,10
10,0	9600	5800	0,50	4800	2900	0,30	3200	1800	0,20
12,0	8000	4800	0,60	4000	2400	0,30	2700	1500	0,20
16,0	6000	3600	0,80	3000	1800	0,50	2000	1100	0,30
20,0	4800	2900	1,00	2400	1400	0,50	1600	880	0,30

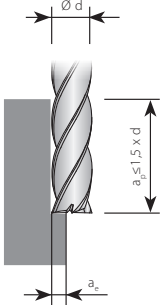
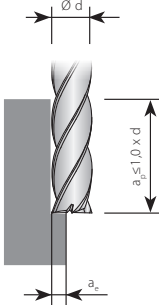



AFH

Nutfräsen / Slot milling

35–70 HRC

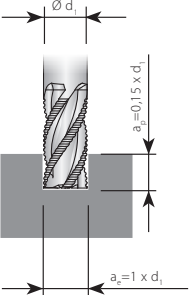
Ø	Stahl / Steel ≤ 1400 N/mm ² (35-45 HRC)					Gehärteter Stahl / hardened steel ≤ 1950 N/mm ² (45-55 HRC)					Gehärteter Stahl / hardened steel > 2000 N/mm ² (55-70 HRC)				
	D [mm]	a _p [mm]	a _e [mm]	n [min ⁻¹]	f _z [mm]	v _f [mm/min]	a _p [mm]	a _e [mm]	n [min ⁻¹]	f _z [mm]	v _f [mm/min]	a _p [mm]	a _e [mm]	n [min ⁻¹]	f _z [mm]
1,0	0,15	1,0	15000	0,008	240	0,15	1,0	12600	0,004	100	0,15	1,0	6300	0,003	38
2,0	0,30	2,0	7600	0,010	152	0,30	2,0	6400	0,006	76	0,30	2,0	3200	0,006	38
3,0	0,45	3,0	5100	0,015	153	0,45	3,0	4200	0,010	84	0,45	3,0	2100	0,009	38
4,0	0,60	4,0	3800	0,025	190	0,60	4,0	3200	0,018	115	0,60	4,0	1600	0,013	41
5,0	0,75	5,0	3100	0,030	186	0,75	5,0	2500	0,025	125	0,75	5,0	1300	0,018	47
6,0	0,90	6,0	2500	0,038	190	0,90	6,0	2100	0,030	126	0,90	6,0	1100	0,021	46
8,0	1,20	8,0	1900	0,050	190	1,20	8,0	1600	0,040	128	1,20	8,0	800	0,028	45
10,0	1,50	10,0	1500	0,063	189	1,50	10,0	1300	0,050	130	1,50	10,0	600	0,035	42
12,0	1,80	12,0	1300	0,070	182	1,80	12,0	1100	0,055	121	1,80	12,0	500	0,039	39
16,0	2,40	16,0	955	0,085	162	2,40	16,0	800	0,060	96	2,40	16,0	400	0,043	35
20,0	3,00	20,0	765	0,112	171	3,00	20,0	640	0,070	90	3,00	20,0	340	0,049	35



Hinweis:
Grundlage der Berechnung ist Zähnezahl Z2.

Information:
Calculation is based on two tooth Z2.

Alle Angaben in mm / Dimensions in mm

Empfohlene Schnittwerte VHM-Vollradiusfräser

Cutting data Solid carbide - Full radius end-mill

Ausführung AFH → Radius 0,05 mm bis 1,5 mm

Design AFH → Radius 0,05 mm to 1,5 mm

Fräser End-mill	Stahl / Steel						Stahl / Steel					Stahl / Steel					Stahl gehärtet / hardened steel					Stahl gehärtet / hardened steel						
	≤ 800 N/mm ² (≥ 22 HRC)						≤ 1100 N/mm ² (25-35 HRC)					≤ 1400 N/mm ² (35-45 HRC)					≤ 1950 N/mm ² (45-55 HRC)					≥ 2000 N/mm ² (55-70 HRC)						
	D	R	l ₁	a _p	a _e	n	f _z	v _f	a _p	a _e	n	f _z	v _f	a _p	a _e	n	f _z	v _f	a _p	a _e	n	f _z	v _f	a _p	a _e	n	f _z	v _f
[mm]	[mm]	[mm]	[mm]	[mm]	[mm]	[mm]	[mm/min]	[mm]	[mm]	[mm]	[mm]	[mm/min]	[mm]	[mm]	[mm]	[mm]	[mm/min]	[mm]	[mm]	[mm]	[mm]	[mm/min]	[mm]	[mm]	[mm]	[mm]	[mm]	[mm/min]
0,10	0,05	0,10	0,008	0,024	50000	0,015	1500	0,007	0,022	50000	0,015	1500	0,006	0,019	50000	0,014	1350	0,005	0,016	45000	0,012	1080	0,005	0,014	42000	0,011	882	
0,10	0,05	0,20	0,008	0,024	50000	0,015	1500	0,007	0,022	50000	0,015	1500	0,006	0,019	50000	0,014	1350	0,005	0,016	45000	0,012	1080	0,005	0,014	42000	0,011	882	
0,20	0,10	0,20	0,020	0,060	50000	0,023	2250	0,018	0,054	45000	0,023	2025	0,016	0,048	42500	0,020	1721	0,013	0,039	37500	0,018	1350	0,012	0,036	35000	0,016	1103	
0,20	0,10	0,30	0,020	0,060	50000	0,023	2250	0,018	0,054	45000	0,023	2025	0,016	0,048	42500	0,020	1721	0,013	0,039	37500	0,018	1350	0,012	0,036	35000	0,016	1103	
0,30	0,15	0,30	0,021	0,063	50000	0,023	2250	0,019	0,057	45000	0,023	2025	0,017	0,050	42500	0,020	1721	0,014	0,041	37500	0,018	1350	0,013	0,038	35000	0,016	1103	
0,30	0,15	0,50	0,021	0,063	50000	0,023	2250	0,019	0,057	45000	0,023	2025	0,017	0,050	42500	0,020	1721	0,014	0,041	37500	0,018	1350	0,013	0,038	35000	0,016	1103	
0,40	0,20	0,40	0,040	0,120	40000	0,030	2400	0,036	0,108	36000	0,030	2160	0,032	0,096	34000	0,027	1836	0,026	0,078	30000	0,024	1440	0,024	0,072	28000	0,021	1176	
0,40	0,20	0,60	0,040	0,120	40000	0,030	2400	0,036	0,108	36000	0,030	2160	0,032	0,096	34000	0,027	1836	0,026	0,078	30000	0,024	1440	0,024	0,072	28000	0,021	1176	
0,50	0,25	0,40	0,045	0,135	40000	0,030	2400	0,041	0,122	36000	0,030	2160	0,036	0,108	34000	0,027	1836	0,029	0,088	30000	0,024	1440	0,027	0,081	28000	0,021	1176	
0,50	0,25	0,50	0,045	0,135	40000	0,030	2400	0,041	0,122	36000	0,030	2160	0,036	0,108	34000	0,027	1836	0,029	0,088	30000	0,024	1440	0,027	0,081	28000	0,021	1176	
0,50	0,25	0,70	0,045	0,135	40000	0,030	2400	0,041	0,122	36000	0,030	2160	0,036	0,108	34000	0,027	1836	0,029	0,088	30000	0,024	1440	0,027	0,081	28000	0,021	1176	
0,60	0,30	0,50	0,042	0,126	40000	0,038	3000	0,038	0,113	36000	0,038	2700	0,034	0,101	34000	0,034	2295	0,027	0,082	30000	0,030	1800	0,025	0,076	28000	0,026	1470	
0,60	0,30	0,60	0,042	0,126	40000	0,038	3000	0,038	0,113	36000	0,038	2700	0,034	0,101	34000	0,034	2295	0,027	0,082	30000	0,030	1800	0,025	0,076	28000	0,026	1470	
0,60	0,30	0,90	0,042	0,126	40000	0,038	3000	0,038	0,113	36000	0,038	2700	0,034	0,101	34000	0,034	2295	0,027	0,082	30000	0,030	1800	0,025	0,076	28000	0,026	1470	
0,70	0,35	1,10	0,080	0,240	40000	0,038	3000	0,072	0,216	36000	0,038	2700	0,064	0,192	34000	0,034	2295	0,052	0,156	30000	0,030	1800	0,048	0,144	28000	0,026	1470	
0,80	0,40	0,60	0,080	0,240	40000	0,038	3000	0,072	0,216	36000	0,038	2700	0,064	0,192	34000	0,034	2295	0,052	0,156	30000	0,030	1800	0,048	0,144	28000	0,026	1470	
0,80	0,40	0,80	0,080	0,240	40000	0,038	3000	0,072	0,216	36000	0,038	2700	0,064	0,192	34000	0,034	2295	0,052	0,156	30000	0,030	1800	0,048	0,144	28000	0,026	1470	
0,80	0,40	1,20	0,080	0,240	40000	0,038	3000	0,072	0,216	36000	0,038	2700	0,064	0,192	34000	0,034	2295	0,052	0,156	30000	0,030	1800	0,048	0,144	28000	0,026	1470	
0,90	0,45	1,40	0,100	0,300	36000	0,045	3240	0,090	0,270	32400	0,045	2916	0,080	0,240	30600	0,041	2479	0,065	0,195	27000	0,036	1944	0,060	0,180	25200	0,032	1588	
1,00	0,50	0,80	0,100	0,300	36000	0,045	3240	0,090	0,270	32400	0,045	2916	0,080	0,240	30600	0,041	2479	0,065	0,195	27000	0,036	1944	0,060	0,180	25200	0,032	1588	
1,00	0,50	1,00	0,100	0,300	36000	0,045	3240	0,090	0,270	32400	0,045	2916	0,080	0,240	30600	0,041	2479	0,065	0,195	27000	0,036	1944	0,060	0,180	25200	0,032	1588	
1,00	0,50	1,50	0,100	0,300	36000	0,045	3240	0,090	0,270	32400	0,045	2916	0,080	0,240	30600	0,041	2479	0,065	0,195	27000	0,036	1944	0,060	0,180	25200	0,032	1588	
1,20	0,60	1,00	0,040	0,120	28800	0,041	2333	0,036	0,108	25920	0,041	2100	0,032	0,096	24480	0,041	1983	0,026	0,078	21600	0,036	1555	0,024	0,072	20160	0,032	1270	
1,20	0,60	1,20	0,040	0,120	28800	0,041	2333	0,036	0,108	25920	0,041	2100	0,032	0,096	24480	0,041	1983	0,026	0,078	21600	0,036	1555	0,024	0,072	20160	0,032	1270	
1,50	0,75	1,20	0,100	0,300	28000	0,045	2520	0,090	0,270	25200	0,045	2268	0,080	0,240	23800	0,041	1928	0,065	0,195	21000	0,036	1512	0,060	0,180	19600	0,032	1235	
1,50	0,75	1,50	0,100	0,300	28000	0,045	2520	0,090	0,270	25200	0,045	2268	0,080	0,240	23800	0,041	1928	0,065	0,195	21000	0,036	1512	0,060	0,180	19600	0,032	1235	
1,50	0,75	2,00	0,100	0,300	28000	0,045	2520	0,090	0,270	25200	0,045	2268	0,080	0,240	23800	0,041	1928	0,065	0,195	21000	0,036	1512	0,060	0,180	19600	0,032	1235	
2,00	1,00	1,60	0,140	0,42	21000	0,075	3150	0,126	0,378	18900	0,075	2835	0,112	0,336	17850	0,075	2678	0,091	0,273	15750	0,060	1890	0,084	0,253	14700	0,053	1544	
2,00	1,00	2,00	0,140	0,42	21000	0,075	3150	0,126	0,378	18900	0,075	2835	0,112	0,336	17850	0,075	2678	0,091	0,273	15750	0,060	1890	0,084	0,253	14700	0,053	1544	
2,00	1,00	2,50	0,140	0,42	21000	0,075	3150	0,126	0,378	18900	0,075	2835	0,112	0,336	17850	0,075	2678	0,091	0,273	15750	0,060	1890	0,084	0,253	14700	0,053	1544	
2,50	1,25	3,00	0,140	0,42	21000	0,075	3150	0,126	0,378	18900	0,075	2835	0,112	0,336	17850	0,075	2678	0,091	0,273	15750	0,060	1890	0,084	0,253	14700	0,053	1544	
3,00	1,50	2,40	0,210	0,630	14400	0,068	1944	0,189	0,567	12960	0,068	1750	0,168	0,504	12240	0,069	1652	0,137	0,410	10800	0,060	1296	0,126	0,380	10080	0,053	1058	
3,00	1,50	3,00	0,210	0,630	14400	0,068	1944	0,189	0,567	12960	0,068	1750	0,168	0,504	12240	0,069	1652	0,137	0,410	10800	0,060	1296	0,126	0,380	10080	0,053	1058	
3,00	1,50	4,00	0,210	0,630	14400	0,068	1944	0,189	0,567	12960	0,068	1750	0,168	0,504	12240	0,069	1652	0,137	0,410	10800	0,060	1296	0,126	0,380	10080	0,053	1058	
3,00	1,50	8,00	0,080	0,240	14400	0,068	1944	0,072	0,216	12960	0,068	1750	0,064	0,192	12240	0,068	1652	0,052	0,156	10800	0,060	1296	0,048	0,144	10080	0,053	1058	

D = Schaftdurchmesser / Shank diameter
R = Radius
l₁ = Schneidlänge / Cutting length

Achtung:
Die Tabellenwerte sind Richtwerte. Es kann notwendig sein, die Werte den jeweiligen Bearbeitungsbedingungen anzupassen.

Attention:
The recommended cutting data are only approximate values. It may be necessary to adjust them to each individual machining application.

Alle Angaben in mm / Dimensions in mm

Empfohlene Schnittwerte VHM-Vollradiusfräser

Cutting data Solid carbide - Full radius end-mill

Ausführung AFH → Radius 2,0 mm bis 12,5 mm

Design AFH → Radius 2,0 mm to 12,5 mm

Radius R [mm]	Gehärteter Stahl / hardened steel (≤ 55 HRC)					Gehärteter Stahl / hardened steel (55–62 HRC)					Gehärteter Stahl / hardened steel (62–70 HRC)				
	α < 15°		α > 15°			α < 15°		α > 15°			α < 15°		α > 15°		
	n [min ⁻¹]	v _f [mm/min]	n [min ⁻¹]	v _f [mm/min]	a _p [mm]	n [min ⁻¹]	v _f [mm/min]	n [min ⁻¹]	v _f [mm/min]	a _p [mm]	n [min ⁻¹]	v _f [mm/min]	n [min ⁻¹]	v _f [mm/min]	a _p [mm]
2,0	32000	10880	20000	3600	0,15	24000	6200	12000	1900	0,13	12000	2400	8000	800	0,10
2,5	25000	9000	16000	2900	0,20	19000	5300	9600	1700	0,15	9600	2100	6000	600	0,10
3,0	21000	8400	13000	2600	0,25	16000	4800	8000	1600	0,20	8000	1700	5000	600	0,11
4,0	16000	6400	10000	2000	0,30	12000	3600	6000	1200	0,20	6000	1400	4000	480	0,11
4,5	14500	5800	9000	1800	0,40	11000	3300	5400	1080	0,20	5400	1200	3500	450	0,11
5,0	13000	5200	8000	1700	0,50	10000	3200	4800	960	0,20	4800	1100	3000	420	0,12
5,5	11000	4400	7000	1450	0,50	8500	2550	4200	840	0,30	3600	860	2200	310	0,12
6,0	9000	3600	6000	1300	0,50	7000	2200	3600	720	0,30	3000	780	1850	290	0,12
8,0	6000	2400	4000	1000	0,50	5000	1600	2500	500	0,30	2500	650	1500	240	0,15
9,0	5500	2200	3500	875	0,50	4500	1400	2100	420	0,30	2200	570	1250	200	0,15
10,0	4500	1800	3000	780	0,50	4000	1300	1800	360	0,30	1800	470	1000	160	0,15
12,5	3500	1400	2000	520	0,50	3500	1100	1500	300	0,30	1500	390	700	105	0,15

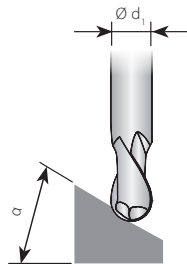

Hinweis:

1. Für den Fall, dass keine stabile Werkstück- und Werkzeugspannung vorhanden ist, oder während der Bearbeitung starke Vibrationen auftreten, empfiehlt es sich, die Höhe des Vorschubes und die Drehzahl proportional zu reduzieren.
2. Bei geringeren Schnitttiefen können Drehzahl und Vorschub erhöht werden.
3. „α“ ist der Bearbeitungswinkel.

Information:

1. In case of unstable workpiece or tool clamping or heavy vibration during machining, we recommend proportional reduction of feed rate and revolutions.
2. At low cutting depths, revolutions and feed rate can be increased.
3. "α" is the machine angle.

AFH

Weitere Highlights unserer Frässysteme.

Other highlights from our milling range.

ARNO®-Frässystem DUO-MILL

Eckfräsen und HFC-Fräsen mit nur einem Werkzeug.



ARNO® milling-system DUO-MILL

Square shoulder and high feed (HFC) milling with just one tool.

ARNO®-Frässystem FTA

Der universelle Planfräser zur Kostenreduzierung.



ARNO® milling-system FTA

Face milling tool for cost reduction.

ARNO®-Frässystem FOA

Der positiv weichschneidende Planfräser, der eine Rundplatte und eine oktagonale Wendschneidplatte in einem Plattensitz vereint.



ARNO® milling-system FOA

The positive face-milling-cutter, in which both a round and an octagonal insert can be used.

Informationen zu diesen Produkten finden Sie unter www.arno.de oder direkt bei ARNO®.

For more information on these products please see our website www.arno.de or contact ARNO®.

ARNO®
WERKZEUGE

Weitere Informationen finden Sie unter:
For more information see:

www.arno.de

Feste Radius-Toleranzen, **radiale Zustellung**
 Tighter **radius tolerance**

0,005-0,010 mm

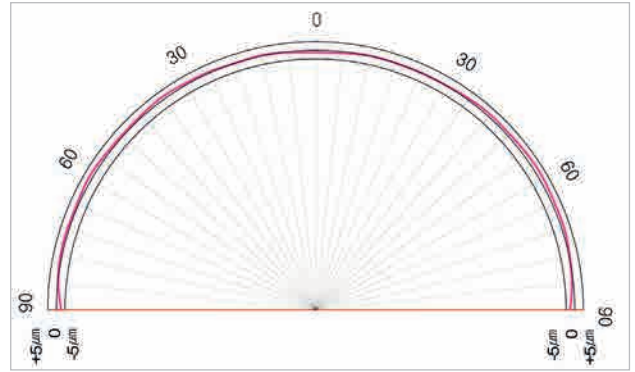
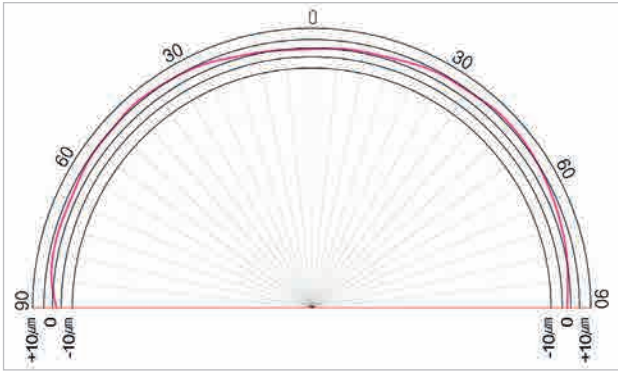

Mit einer Radius-Toleranz von $\pm 0,005$ mm ist eine höhere Genauigkeit und längere Standzeit garantiert.
 Tighter radius tolerance $\pm 0,005$ mm for a higher accuracy and longer tool life.

Polierte Oberflächen und speziell entwickelte Beschichtung für beste Zerspanungsergebnisse auch in der Hochgeschwindigkeitsbearbeitung:

Polished surface and specifically engineered coating for the best results also for high speed machining:



Hochgeschwindigkeitsfräser
 High end-mill



Herkömmlicher Fräser
 Normal end-mill

Speziell entwickelte Hochleistungsbeschichtung – besonders leistungsstark in der Hochgeschwindigkeitsbearbeitung – oder der Bearbeitung hochharter Werkstoffe.

Special coating give consistent result in high speed cutting of high hardness materials.

Vergleich der Schneidkantenformen: Hochgeschwindigkeitsbearbeitung - normale Bearbeitung

Comparison of the endteeth shape: **HIGH FEED END-MILL - NORMAL END-MILL**

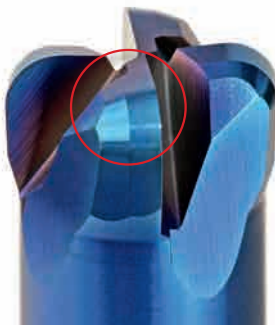

Hochgeschwindigkeitsfräser
 High end-mill



Herkömmlicher Fräser
 Normal end-mill

Vergleich der Schneidkantenformen: **Hochgeschwindigkeitsbearbeitung – normale Bearbeitung**
Comparison of the endteeth shape: **HIGH FEED END-MILL - NORMAL END-MILL**



Extra kurze Schneidenlänge für höchste Stabilität.
Extra short flutes length for high rigidity.

Reduzierter Freiwinkel, kurze Schneide, verstärkter Eckenradius und verkürzte Kantenführung.
Reduced clearance angles and short strengthens corner radius and reduces chattering.

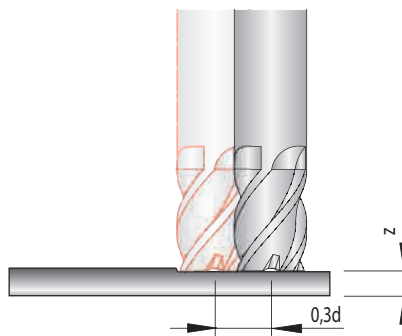
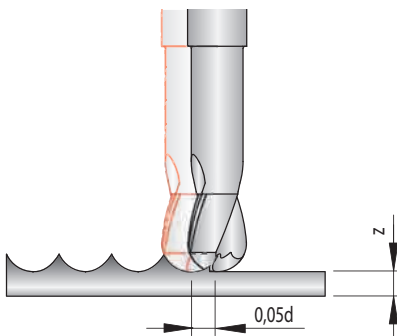

AFH

Anwendungsbeispiel
Example of performance

(HRC 50 - 55)

Werkzeug/Item	Größe/Size [mm]	Drehzahl/Revolution [U/min] / RPM	Vorschub/Feed rate [mm/U]	Zustellung/Depth of cut	
				Z [mm]	X-Y [mm]
Hochgeschwindigkeitsfräser High feed end-mill	Ø10 R2	5400	11000	0,2	3,0

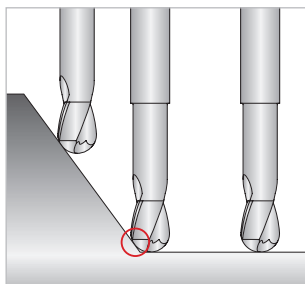

Radiusfräser
Ball-nose milling cutter

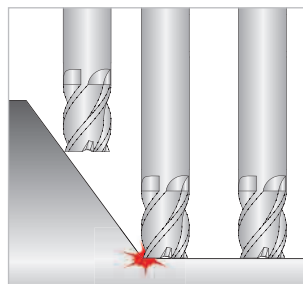

Schaftfräser
End-mill

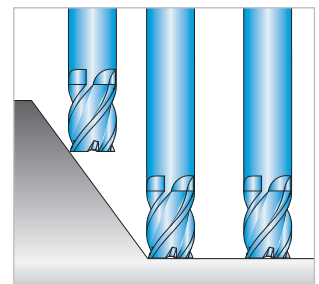

Torus-Schaftfräser
Torus end-mill

Empfohlene Schnittwerte VHM-Torus-Schafffräser/Hochvorschubfräser – Richtwerte für den Vorschub pro Zahn f_z [mm]

Ausführung AFH

ISO	Werkstoff	Festigkeit [N/mm ²]	Mittlere Bearbeitung V_c [m/min]	Schrupp- bearbeitung V_c [m/min]	Mittel $d_1=2$ mm		Schruppen $d_1=2$ mm	
					a_p [mm]	f_z [mm]	a_p [mm]	f_z [mm]
P	Allgemeiner Baustahl	< 800	250-300	150-250	0,05-0,2	0,1-0,2	0,2-0,3	0,2-0,3
	Automatenstahl	< 800	250-300	150-250	0,05-0,2	0,1-0,2	0,2-0,3	0,2-0,3
	Einsatzstahl, unlegiert	< 800	250-300	150-250	0,05-0,2	0,1-0,2	0,2-0,3	0,2-0,3
	Einsatzstahl, legiert	< 1000	200-250	180-200	0,05-0,2	0,1-0,2	0,2-0,3	0,2-0,3
	Vergütungsstahl, unlegiert	< 850	220-250	200-220	0,05-0,2	0,1-0,2	0,2-0,3	0,2-0,3
	Vergütungsstahl, unlegiert	< 1000	220-250	200-220	0,05-0,2	0,1-0,2	0,2-0,3	0,2-0,3
	Vergütungsstahl, legiert	< 800	170-190	170-190	0,05-0,2	0,1-0,2	0,2-0,3	0,2-0,3
	Vergütungsstahl, legiert	< 1300	160-180	160-180	0,05-0,2	0,1-0,2	0,2-0,3	0,2-0,3
	Stahlguss	< 850	220-250	200-220	0,05-0,2	0,1-0,2	0,2-0,3	0,2-0,3
	Nitrierstahl	< 1000	170-190	170-190	0,05-0,2	0,1-0,2	0,2-0,3	0,2-0,3
	Nitrierstahl	< 1200	160-180	160-180	0,05-0,2	0,1-0,2	0,2-0,3	0,2-0,3
	Wälzlagerstahl	< 1200	170-190	170-190	0,05-0,2	0,1-0,2	0,2-0,3	0,2-0,3
	Federstahl	< 1200	100-120	100-120	0,05-0,2	0,1-0,2	0,2-0,3	0,2-0,3
	Schnellarbeitsstahl	< 1300	80-100	80-100	0,05-0,2	0,1-0,2	0,2-0,3	0,2-0,3
	Werkzeugstahl für Kaltarbeit	< 1300	140-180	140-180	0,05-0,2	0,1-0,2	0,2-0,3	0,2-0,3
Werkzeugstahl für Warmarbeit	< 1300	140-180	140-180	0,05-0,2	0,1-0,2	0,2-0,3	0,2-0,3	
M	Stahl und Stahlguss, rostfrei geschwefelt	< 850	110-150	70-110	0,05-0,2	0,1-0,2	0,2-0,3	0,2-0,3
	Nichtrostender Stahl, ferritisch	< 750	110-150	70-110	0,05-0,2	0,1-0,2	0,2-0,3	0,2-0,3
	Nichtrostender Stahl, martensitisch	< 900	110-150	70-110	0,05-0,2	0,1-0,2	0,2-0,3	0,2-0,3
	Nichtrostender Stahl, ferritisch/martensitisch	< 1100	110-150	70-110	0,05-0,2	0,1-0,2	0,2-0,3	0,2-0,3
	Nichtrostender Stahl, austenitisch/ferritisch	< 850	110-150	70-110	0,05-0,2	0,1-0,2	0,2-0,3	0,2-0,3
	Nichtrostender Stahl, austenitisch	< 750	80-110	60-90	0,05-0,2	0,1-0,2	0,2-0,3	0,2-0,3
Hitzebeständig	< 1100	80-110	60-90	0,05-0,2	0,1-0,2	0,2-0,3	0,2-0,3	
K	Grauguss mit Lammellengraphit	100-350	300-350	250-300	0,05-0,2	0,1-0,2	0,2-0,3	0,2-0,3
	Grauguss mit Lammellengraphit	300-1000	180-250	180-250	0,05-0,2	0,1-0,2	0,2-0,3	0,2-0,3
	Kugelgraphitguss	300-500	200-250	150-200	0,05-0,2	0,1-0,2	0,2-0,3	0,2-0,3
	Kugelgraphitguss	550-800	200-250	150-200	0,05-0,2	0,1-0,2	0,2-0,3	0,2-0,3
	Temperguss, weiß	350-450	200-250	150-200	0,05-0,2	0,1-0,2	0,2-0,3	0,2-0,3
	Temperguss, weiß	500-650	200-250	150-200	0,05-0,2	0,1-0,2	0,2-0,3	0,2-0,3
	Temperguss, schwarz	350-450	200-250	150-200	0,05-0,2	0,1-0,2	0,2-0,3	0,2-0,3
Temperguss, schwarz	500-700	200-250	150-200	0,05-0,2	0,1-0,2	0,2-0,3	0,2-0,3	
N	Aluminium (unlegiert, niedrig legiert)	< 350	400-600	400-600	0,05-0,2	0,1-0,2	0,2-0,3	0,2-0,3
	Aluminiumlegierungen < 0,5% Si	< 500	400-600	400-600	0,05-0,2	0,1-0,2	0,2-0,3	0,2-0,3
	Aluminiumlegierungen 0,5-10% Si	< 400	400-600	400-600	0,05-0,2	0,1-0,2	0,2-0,3	0,2-0,3
	Aluminiumlegierungen 10-15% Si	< 400	400-600	400-600	0,05-0,2	0,1-0,2	0,2-0,3	0,2-0,3
	Aluminiumlegierungen > 15% Si	< 400	400-600	400-600	0,05-0,2	0,1-0,2	0,2-0,3	0,2-0,3
	Kupfer (unlegiert, niedrig legiert)	< 350	300-500	300-500	0,05-0,2	0,1-0,2	0,2-0,3	0,2-0,3
	Kupfer-Knetlegierungen	< 700	300-500	300-500	0,05-0,2	0,1-0,2	0,2-0,3	0,2-0,3
	Kupfer-Sonderlegierungen	< 200 HB	300-500	300-500	0,05-0,2	0,1-0,2	0,2-0,3	0,2-0,3
	Kupfer-Sonderlegierungen	< 300 HB	300-500	300-500	0,05-0,2	0,1-0,2	0,2-0,3	0,2-0,3
	Kupfer-Sonderlegierungen	> 300 HB	300-500	300-500	0,05-0,2	0,1-0,2	0,2-0,3	0,2-0,3
	Messing kurzspanend, Bronze, Rotguss	< 600	300-500	300-500	0,05-0,2	0,1-0,2	0,2-0,3	0,2-0,3
	Messing langspanend	< 600	300-500	300-500	0,05-0,2	0,1-0,2	0,2-0,3	0,2-0,3
	Thermoplaste							
	Duroplaste							
	Faserverstärkte Kunststoffe							
Magnesium und Magnesiumlegierungen	< 850							
Graphit								
Wolfram und Wolframlegierungen								
Molybdän und Molybdänlegierungen								
S	Reinnickel							
	Nickellegierungen							
	Nickellegierungen	< 850						
	Nickel-Chromlegierungen		50-80	30-50	0,05-0,2	0,1-0,2	0,2-0,3	0,2-0,3
	Nickel- und Kobaltlegierungen	< 1300						
	Hochwarmfeste Legierungen	< 1300						
	Nickel-Kobalt-(Chrom-)legierungen	< 1400	50-80	30-50	0,05-0,2	0,1-0,2	0,2-0,3	0,2-0,3
	Nickel- und Kobaltlegierungen	< 1300						
	Reintitan	< 900						
Titanlegierungen	< 700	60-80	60-80					
Titanlegierungen	< 1200	40-80	40-80					
H	Stahl gehärtet	< 45 HRC	160-190	160-190	0,05-0,2	0,1-0,2	0,2-0,3	0,2-0,3
		46-55 HRC	150-180	80-120	0,05-0,2	0,1-0,2	0,2-0,3	0,2-0,3
		56-60 HRC	120-150	80-100	0,05-0,2	0,1-0,2	0,2-0,3	0,2-0,25
		61-65 HRC	80-110	60-90	0,05-0,2	0,1-0,2	0,2-0,3	0,2-0,25
		65-70 HRC						

Die Tabellenwerte sind Richtwerte. Es kann notwendig sein, die Werte den jeweiligen Bearbeitungsbedingungen anzupassen.

Empfohlene Schnittwerte VHM-Torus-Schafffräser/Hochvorschubfräser – Richtwerte für den Vorschub pro Zahn f_z [mm]

Ausführung AFH

ISO	Werkstoff	Festigkeit [N/mm ²]	Mittlere Bearbeitung V_c [m/min]	Schrupp- bearbeitung V_c [m/min]	Mittel $d_f = 8$ mm		Schruppen $d_f = 8$ mm	
					a_p [mm]	f_z [mm]	a_p [mm]	f_z [mm]
P	Allgemeiner Baustahl	< 800	250-300	150-250	0,1-0,2	0,1-0,3	0,2-0,3	0,3-0,5
	Automatenstahl	< 800	250-300	150-250	0,1-0,2	0,1-0,3	0,2-0,3	0,3-0,5
	Einsatzstahl, unlegiert	< 800	250-300	150-250	0,1-0,2	0,1-0,3	0,2-0,3	0,3-0,5
	Einsatzstahl, legiert	< 1000	200-250	180-200	0,1-0,2	0,1-0,25	0,2-0,3	0,25-0,4
	Vergütungsstahl, unlegiert	< 850	220-250	200-220	0,1-0,2	0,1-0,25	0,2-0,3	0,25-0,4
	Vergütungsstahl, unlegiert	< 1000	220-250	200-220	0,1-0,2	0,1-0,25	0,2-0,3	0,25-0,4
	Vergütungsstahl, legiert	< 800	170-190	170-190	0,1-0,2	0,1-0,25	0,2-0,3	0,25-0,4
	Vergütungsstahl, legiert	< 1300	160-180	160-180	0,1-0,2	0,1-0,25	0,2-0,3	0,25-0,4
	Stahlguss	< 850	220-250	200-220	0,1-0,2	0,1-0,25	0,2-0,3	0,25-0,4
	Nitrierstahl	< 1000	170-190	170-190	0,1-0,2	0,1-0,25	0,2-0,3	0,25-0,4
	Nitrierstahl	< 1200	160-180	160-180	0,1-0,2	0,1-0,25	0,2-0,3	0,25-0,4
	Wälzlagerstahl	< 1200	170-190	170-190	0,1-0,2	0,1-0,25	0,2-0,3	0,25-0,4
	Federstahl	< 1200	100-120	100-120	0,1-0,2	0,1-0,25	0,2-0,3	0,25-0,4
	Schnellarbeitsstahl	< 1300	80-100	80-100	0,1-0,2	0,1-0,25	0,2-0,3	0,25-0,4
	Werkzeugstahl für Kaltarbeit	< 1300	140-180	140-180	0,1-0,2	0,1-0,25	0,2-0,3	0,25-0,4
Werkzeugstahl für Warmarbeit	< 1300	140-180	140-180	0,1-0,2	0,1-0,25	0,2-0,3	0,25-0,4	
M	Stahl und Stahlguss, rostfrei geschwefelt	< 850	110-150	70-110	0,1-0,2	0,1-0,25	0,2-0,3	0,25-0,4
	Nichtrostender Stahl, ferritisch	< 750	110-150	70-110	0,1-0,2	0,1-0,25	0,2-0,3	0,25-0,4
	Nichtrostender Stahl, martensitisch	< 900	110-150	70-110	0,1-0,2	0,1-0,25	0,2-0,3	0,25-0,4
	Nichtrostender Stahl, ferritisch/martensitisch	< 1100	110-150	70-110	0,1-0,2	0,1-0,25	0,2-0,3	0,25-0,4
	Nichtrostender Stahl, austenitisch/ferritisch	< 850	110-150	70-110	0,1-0,2	0,1-0,25	0,2-0,3	0,25-0,4
	Nichtrostender Stahl, austenitisch	< 750	80-110	60-90	0,1-0,2	0,1-0,25	0,2-0,3	0,25-0,4
Hitzebeständig	< 1100	80-110	60-90	0,1-0,2	0,1-0,25	0,2-0,3	0,25-0,4	
K	Grauguss mit Lammellengraphit	100-350	300-350	250-300	0,1-0,2	0,1-0,3	0,2-0,3	0,3-0,5
	Grauguss mit Lammellengraphit	300-1000	180-250	180-250	0,1-0,2	0,1-0,3	0,2-0,3	0,3-0,5
	Kugelgraphitguss	300-500	200-250	150-200	0,1-0,2	0,1-0,25	0,2-0,3	0,25-0,4
	Kugelgraphitguss	550-800	200-250	150-200	0,1-0,2	0,1-0,25	0,2-0,3	0,25-0,4
	Temperguss, weiß	350-450	200-250	150-200	0,1-0,2	0,1-0,25	0,2-0,3	0,25-0,4
	Temperguss, weiß	500-650	200-250	150-200	0,1-0,2	0,1-0,25	0,2-0,3	0,25-0,4
	Temperguss, schwarz	350-450	200-250	150-200	0,1-0,2	0,1-0,25	0,2-0,3	0,25-0,4
	Temperguss, schwarz	500-700	200-250	150-200	0,1-0,2	0,1-0,25	0,2-0,3	0,25-0,4
N	Aluminium (unlegiert, niedrig legiert)	< 350	400-600	400-600	0,1-0,2	0,1-0,3	0,2-0,3	0,3-0,5
	Aluminiumlegierungen < 0,5% Si	< 500	400-600	400-600	0,1-0,2	0,1-0,3	0,2-0,3	0,3-0,5
	Aluminiumlegierungen 0,5 - 10% Si	< 400	400-600	400-600	0,1-0,2	0,1-0,3	0,2-0,3	0,3-0,5
	Aluminiumlegierungen 10 - 15% Si	< 400	400-600	400-600	0,1-0,2	0,1-0,3	0,2-0,3	0,3-0,5
	Aluminiumlegierungen > 15% Si	< 400	400-600	400-600	0,1-0,2	0,1-0,3	0,2-0,3	0,3-0,5
	Kupfer (unlegiert, niedrig legiert)	< 350	300-500	300-500	0,1-0,2	0,1-0,3	0,2-0,3	0,3-0,5
	Kupfer-Knetlegierungen	< 700	300-500	300-500	0,1-0,2	0,1-0,3	0,2-0,3	0,3-0,5
	Kupfer-Sonderlegierungen	< 200 HB	300-500	300-500	0,1-0,2	0,1-0,3	0,2-0,3	0,3-0,5
	Kupfer-Sonderlegierungen	< 300 HB	300-500	300-500	0,1-0,2	0,1-0,3	0,2-0,3	0,3-0,5
	Kupfer-Sonderlegierungen	> 300 HB	300-500	300-500	0,1-0,2	0,1-0,3	0,2-0,3	0,3-0,5
	Messing kurzspanend, Bronze, Rotguss	< 600	300-500	300-500	0,1-0,2	0,1-0,3	0,2-0,3	0,3-0,5
	Messing langspanend	< 600	300-500	300-500	0,1-0,2	0,1-0,3	0,2-0,3	0,3-0,5
	Thermoplaste							
	Duroplaste							
	Faserverstärkte Kunststoffe							
	Magnesium und Magnesiumlegierungen	< 850						
	Graphit							
Wolfram und Wolframlegierungen								
Molybdän und Molybdänlegierungen								
S	Reinnickel							
	Nickellegierungen							
	Nickellegierungen	< 850						
	Nickel-Chromlegierungen		50-80	30-50	0,1-0,2	0,1-0,3	0,2-0,3	0,3-0,5
	Nickel- und Kobaltlegierungen	< 1300						
	Hochwarmfeste Legierungen	< 1300						
	Nickel-Kobalt-(Chrom-)legierungen	< 1400	50-80	30-50	0,1-0,2	0,1-0,3	0,2-0,3	0,3-0,5
	Nickel- und Kobaltlegierungen	< 1300						
	Reintitan	< 900						
Titanlegierungen	< 700	60-80	60-80	0,1-0,2	0,1-0,3	0,2-0,3	0,3-0,5	
Titanlegierungen	< 1200	40-80	40-80	0,1-0,2	0,1-0,3	0,2-0,3	0,3-0,5	
H	Stahl gehärtet	< 45 HRC	160-190	160-190	0,1-0,2	0,1-0,3	0,2-0,3	0,3-0,5
		46-55 HRC	150-180	80-120	0,1-0,2	0,1-0,25	0,2-0,3	0,25-0,4
		56-60 HRC	120-150	80-100	0,1-0,2	0,1-0,25	0,2-0,3	0,2-0,3
		61-65 HRC	80-110	60-90	0,1-0,2	0,1-0,25	0,2-0,3	0,2-0,3
		65-70 HRC						

Die Tabellenwerte sind Richtwerte. Es kann notwendig sein, die Werte den jeweiligen Bearbeitungsbedingungen anzupassen.

Recommended cutting data solid carbide High feed end-mill – Approximate values Feed per tooth f_z [mm]

Design AFH

ISO	Material	Strength [N/mm ²]	Medium machining V_c [m/min]	Rough machining V_c [m/min]	Medium $d_1 = 2$ mm		Roughing $d_1 = 2$ mm	
					a_p [mm]	f_z [mm]	a_p [mm]	f_z [mm]
P	General construction steel	< 800	250-300	150-250	0,05-0,2	0,1-0,2	0,2-0,3	0,2-0,3
	Free cutting steel	< 800	250-300	150-250	0,05-0,2	0,1-0,2	0,2-0,3	0,2-0,3
	Case hardened steel, non alloyed	< 800	250-300	150-250	0,05-0,2	0,1-0,2	0,2-0,3	0,2-0,3
	Alloyed case hardened steel	< 1000	200-250	180-200	0,05-0,2	0,1-0,2	0,2-0,3	0,2-0,3
	Tempering steel, non alloyed	< 850	220-250	200-220	0,05-0,2	0,1-0,2	0,2-0,3	0,2-0,3
	Tempering steel, non alloyed	< 1000	220-250	200-220	0,05-0,2	0,1-0,2	0,2-0,3	0,2-0,3
	Tempering steel, alloyed	< 800	170-190	170-190	0,05-0,2	0,1-0,2	0,2-0,3	0,2-0,3
	Tempering steel, alloyed	< 1300	160-180	160-180	0,05-0,2	0,1-0,2	0,2-0,3	0,2-0,3
	Steel castings	< 850	220-250	200-220	0,05-0,2	0,1-0,2	0,2-0,3	0,2-0,3
	Nitriding steel	< 1000	170-190	170-190	0,05-0,2	0,1-0,2	0,2-0,3	0,2-0,3
	Nitriding steel	< 1200	160-180	160-180	0,05-0,2	0,1-0,2	0,2-0,3	0,2-0,3
	Roller bearing steel	< 1200	170-190	170-190	0,05-0,2	0,1-0,2	0,2-0,3	0,2-0,3
	Spring steel	< 1200	100-120	100-120	0,05-0,2	0,1-0,2	0,2-0,3	0,2-0,3
	High-speed steel	< 1300	80-100	80-100	0,05-0,2	0,1-0,2	0,2-0,3	0,2-0,3
Cold working tool steel	< 1300	140-180	140-180	0,05-0,2	0,1-0,2	0,2-0,3	0,2-0,3	
Hot working tool steel	< 1300	140-180	140-180	0,05-0,2	0,1-0,2	0,2-0,3	0,2-0,3	
M	Steel and sulphured cast stainless steel	< 850	110-150	70-110	0,05-0,2	0,1-0,2	0,2-0,3	0,2-0,3
	Stainless steel, ferritic	< 750	110-150	70-110	0,05-0,2	0,1-0,2	0,2-0,3	0,2-0,3
	Stainless steel, martensitic	< 900	110-150	70-110	0,05-0,2	0,1-0,2	0,2-0,3	0,2-0,3
	Stainless steel, ferritic / martensitic	< 1100	110-150	70-110	0,05-0,2	0,1-0,2	0,2-0,3	0,2-0,3
	Stainless steel, austenitic / ferritic	< 850	110-150	70-110	0,05-0,2	0,1-0,2	0,2-0,3	0,2-0,3
	Stainless steel, austenitic	< 750	80-110	60-90	0,05-0,2	0,1-0,2	0,2-0,3	0,2-0,3
	Heat resistant steel	< 1100	80-110	60-90	0,05-0,2	0,1-0,2	0,2-0,3	0,2-0,3
K	Grey cast iron with lamellar graphite	100-350	300-350	250-300	0,05-0,2	0,1-0,2	0,2-0,3	0,2-0,3
	Grey cast iron with lamellar graphite	300-1000	180-250	180-250	0,05-0,2	0,1-0,2	0,2-0,3	0,2-0,3
	Spheroidal cast iron	300-500	200-250	150-200	0,05-0,2	0,1-0,2	0,2-0,3	0,2-0,3
	Spheroidal cast iron	550-800	200-250	150-200	0,05-0,2	0,1-0,2	0,2-0,3	0,2-0,3
	White cast iron, tempered	350-450	200-250	150-200	0,05-0,2	0,1-0,2	0,2-0,3	0,2-0,3
	White cast iron, tempered	500-650	200-250	150-200	0,05-0,2	0,1-0,2	0,2-0,3	0,2-0,3
	Black cast iron, tempered	350-450	200-250	150-200	0,05-0,2	0,1-0,2	0,2-0,3	0,2-0,3
	Black cast iron, tempered	500-700	200-250	150-200	0,05-0,2	0,1-0,2	0,2-0,3	0,2-0,3
N	Aluminium (non alloyed, low alloyed)	< 350	400-600	400-600	0,05-0,2	0,1-0,2	0,2-0,3	0,2-0,3
	Aluminium alloys < 0,5% Si	< 500	400-600	400-600	0,05-0,2	0,1-0,2	0,2-0,3	0,2-0,3
	Aluminium alloys 0,5% - 10% Si	< 400	400-600	400-600	0,05-0,2	0,1-0,2	0,2-0,3	0,2-0,3
	Aluminium alloys 10% - 15% Si	< 400	400-600	400-600	0,05-0,2	0,1-0,2	0,2-0,3	0,2-0,3
	Aluminium alloys > 15% Si	< 400	400-600	400-600	0,05-0,2	0,1-0,2	0,2-0,3	0,2-0,3
	Copper (non alloyed, low alloyed)	< 350	300-500	300-500	0,05-0,2	0,1-0,2	0,2-0,3	0,2-0,3
	Copper wrought alloys	< 700	300-500	300-500	0,05-0,2	0,1-0,2	0,2-0,3	0,2-0,3
	Special copper alloys	< 200 HB	300-500	300-500	0,05-0,2	0,1-0,2	0,2-0,3	0,2-0,3
	Special copper alloys	< 300 HB	300-500	300-500	0,05-0,2	0,1-0,2	0,2-0,3	0,2-0,3
	Special copper alloys	> 300 HB	300-500	300-500	0,05-0,2	0,1-0,2	0,2-0,3	0,2-0,3
	Short-chipping brass, bronze, red bronze	< 600	300-500	300-500	0,05-0,2	0,1-0,2	0,2-0,3	0,2-0,3
	Long-chipping brass	< 600	300-500	300-500	0,05-0,2	0,1-0,2	0,2-0,3	0,2-0,3
	Thermoplastics							
	Duroplastics							
	Fibre-reinforced plastics							
	Magnesium and magnesium alloys	< 850						
	Graphite							
Tungsten and tungsten alloys								
Molybdenum and molybdenum alloys								
S	Pure nickel							
	Nickel alloys							
	Nickel alloys	< 850						
	Nickel-chromium alloys		50-80	30-50	0,05-0,2	0,1-0,2	0,2-0,3	0,2-0,3
	Nickel and cobalt alloys	< 1300						
	Nickel and cobalt alloys	< 1300						
	Heat resistant alloys	< 1400	50-80	30-50	0,05-0,2	0,1-0,2	0,2-0,3	0,2-0,3
	Nickel-cobalt-chromium alloys	< 1300						
	Pure titanium	< 900						
H	Titanium alloys	< 700	60-80	60-80				
	Titanium alloys	< 1200	40-80	40-80				
	Tempered steel	< 45 HRC	160-190	160-190	0,05-0,2	0,1-0,2	0,2-0,3	0,2-0,3
		46-55 HRC	150-180	80-120	0,05-0,2	0,1-0,2	0,2-0,3	0,2-0,3
		56-60 HRC	120-150	80-100	0,05-0,2	0,1-0,2	0,2-0,3	0,2-0,25
	61-65 HRC	80-110	60-90	0,05-0,2	0,1-0,2	0,2-0,3	0,2-0,25	
	65-70 HRC							

The recommended cutting data are only approximate values. It may be necessary to adjust them to each individual machining application.

Recommended cutting data solid carbide High feed end-mill – Approximate values Feed per tooth f_z [mm]

Design AFH

ISO	Material	Strength [N/mm ²]	Medium machining V_c [m/min]	Rough machining V_c [m/min]	Medium $d_t = 8$ mm		Roughing $d_t = 8$ mm	
					a_p [mm]	f_z [mm]	a_p [mm]	f_z [mm]
P	General construction steel	< 800	250 - 300	150-250	0,1-0,2	0,1-0,3	0,2-0,3	0,3-0,5
	Free cutting steel	< 800	250-300	150-250	0,1-0,2	0,1-0,3	0,2-0,3	0,3-0,5
	Case hardened steel, non alloyed	< 800	250-300	150-250	0,1-0,2	0,1-0,3	0,2-0,3	0,3-0,5
	Alloyed case hardened steel	< 1000	200-250	180-200	0,1-0,2	0,1-0,25	0,2-0,3	0,25-0,4
	Tempering steel, non alloyed	< 850	220-250	200-220	0,1-0,2	0,1-0,25	0,2-0,3	0,25-0,4
	Tempering steel, non alloyed	< 1000	220-250	200-220	0,1-0,2	0,1-0,25	0,2-0,3	0,25-0,4
	Tempering steel, alloyed	< 800	170-190	170-190	0,1-0,2	0,1-0,25	0,2-0,3	0,25-0,4
	Tempering steel, alloyed	< 1300	160-180	160-180	0,1-0,2	0,1-0,25	0,2-0,3	0,25-0,4
	Steel castings	< 850	220-250	200-220	0,1-0,2	0,1-0,25	0,2-0,3	0,25-0,4
	Nitriding steel	< 1000	170-190	170-190	0,1-0,2	0,1-0,25	0,2-0,3	0,25-0,4
	Nitriding steel	< 1200	160-180	160-180	0,1-0,2	0,1-0,25	0,2-0,3	0,25-0,4
	Roller bearing steel	< 1200	170-190	170-190	0,1-0,2	0,1-0,25	0,2-0,3	0,25-0,4
	Spring steel	< 1200	100-120	100-120	0,1-0,2	0,1-0,25	0,2-0,3	0,25-0,4
	High-speed steel	< 1300	80-100	80-100	0,1-0,2	0,1-0,25	0,2-0,3	0,25-0,4
Cold working tool steel	< 1300	140-180	140-180	0,1-0,2	0,1-0,25	0,2-0,3	0,25-0,4	
Hot working tool steel	< 1300	140-180	140-180	0,1-0,2	0,1-0,25	0,2-0,3	0,25-0,4	
M	Steel and sulphured cast stainless steel	< 850	110-150	70-110	0,1-0,2	0,1-0,25	0,2-0,3	0,25-0,4
	Stainless steel, ferritic	< 750	110-150	70-110	0,1-0,2	0,1-0,25	0,2-0,3	0,25-0,4
	Stainless steel, martensitic	< 900	110-150	70-110	0,1-0,2	0,1-0,25	0,2-0,3	0,25-0,4
	Stainless steel, ferritic/martensitic	< 1100	110-150	70-110	0,1-0,2	0,1-0,25	0,2-0,3	0,25-0,4
	Stainless steel, austenitic/ferritic	< 850	110-150	70-110	0,1-0,2	0,1-0,25	0,2-0,3	0,25-0,4
	Stainless steel, austenitic	< 750	80-110	60-90	0,1-0,2	0,1-0,25	0,2-0,3	0,25-0,4
	Heat resistant steel	< 1100	80-110	60-90	0,1-0,2	0,1-0,25	0,2-0,3	0,25-0,4
K	Grey cast iron with lamellar graphite	100-350	300-350	250-300	0,1-0,2	0,1-0,3	0,2-0,3	0,3-0,5
	Grey cast iron with lamellar graphite	300-1000	180-250	180-250	0,1-0,2	0,1-0,3	0,2-0,3	0,3-0,5
	Spheroidal cast iron	300-500	200-250	150-200	0,1-0,2	0,1-0,25	0,2-0,3	0,25-0,4
	Spheroidal cast iron	550-800	200-250	150-200	0,1-0,2	0,1-0,25	0,2-0,3	0,25-0,4
	White cast iron, tempered	350-450	200-250	150-200	0,1-0,2	0,1-0,25	0,2-0,3	0,25-0,4
	White cast iron, tempered	500-650	200-250	150-200	0,1-0,2	0,1-0,25	0,2-0,3	0,25-0,4
	Black cast iron, tempered	350-450	200-250	150-200	0,1-0,2	0,1-0,25	0,2-0,3	0,25-0,4
	Black cast iron, tempered	500-700	200-250	150-200	0,1-0,2	0,1-0,25	0,2-0,3	0,25-0,4
N	Aluminium (non alloyed, low alloyed)	< 350	400-600	400-600	0,1-0,2	0,1-0,3	0,2-0,3	0,3-0,5
	Aluminium alloys < 0,5% Si	< 500	400-600	400-600	0,1-0,2	0,1-0,3	0,2-0,3	0,3-0,5
	Aluminium alloys 0,5% - 10% Si	< 400	400-600	400-600	0,1-0,2	0,1-0,3	0,2-0,3	0,3-0,5
	Aluminium alloys 10% - 15% Si	< 400	400-600	400-600	0,1-0,2	0,1-0,3	0,2-0,3	0,3-0,5
	Aluminium alloys > 15% Si	< 400	400-600	400-600	0,1-0,2	0,1-0,3	0,2-0,3	0,3-0,5
	Copper (non alloyed, low alloyed)	< 350	300-500	300-500	0,1-0,2	0,1-0,3	0,2-0,3	0,3-0,5
	Copper wrought alloys	< 700	300-500	300-500	0,1-0,2	0,1-0,3	0,2-0,3	0,3-0,5
	Special copper alloys	< 200 HB	300-500	300-500	0,1-0,2	0,1-0,3	0,2-0,3	0,3-0,5
	Special copper alloys	< 300 HB	300-500	300-500	0,1-0,2	0,1-0,3	0,2-0,3	0,3-0,5
	Special copper alloys	> 300 HB	300-500	300-500	0,1-0,2	0,1-0,3	0,2-0,3	0,3-0,5
	Short-chipping brass, bronze, red bronze	< 600	300-500	300-500	0,1-0,2	0,1-0,3	0,2-0,3	0,3-0,5
	Long-chipping brass	< 600	300-500	300-500	0,1-0,2	0,1-0,3	0,2-0,3	0,3-0,5
	Thermoplastics							
	Duroplastics							
	Fibre-reinforced plastics							
	Magnesium and magnesium alloys	< 850						
	Graphite							
Tungsten and tungsten alloys								
Molybdenum and molybdenum alloys								
S	Pure nickel							
	Nickel alloys							
	Nickel alloys	< 850						
	Nickel-chromium alloys		50-80	30-50	0,1-0,2	0,1-0,3	0,2-0,3	0,3-0,5
	Nickel and cobalt alloys	< 1300						
	Nickel and cobalt alloys	< 1300						
	Heat resistant alloys	< 1400	50-80	30-50	0,1-0,2	0,1-0,3	0,2-0,3	0,3-0,5
	Nickel-cobalt-chromium alloys	< 1300						
	Pure titanium	< 900						
H	Titanium alloys	< 700	60-80	60-80	0,1-0,2	0,1-0,3	0,2-0,3	0,3-0,5
	Titanium alloys	< 1200	40-80	40-80	0,1-0,2	0,1-0,3	0,2-0,3	0,3-0,5
	Tempered steel	< 45 HRC	160-190	160-190	0,1-0,2	0,1-0,3	0,2-0,3	0,3-0,5
		46-55 HRC	150-180	80-120	0,1-0,2	0,1-0,25	0,2-0,3	0,25-0,4
		56-60 HRC	120-150	80-100	0,1-0,2	0,1-0,25	0,2-0,3	0,2-0,3
	61-65 HRC	80-110	60-90	0,1-0,2	0,1-0,25	0,2-0,3	0,2-0,3	
	65-70 HRC							

The recommended cutting data are only approximate values. It may be necessary to adjust them to each individual machining application.

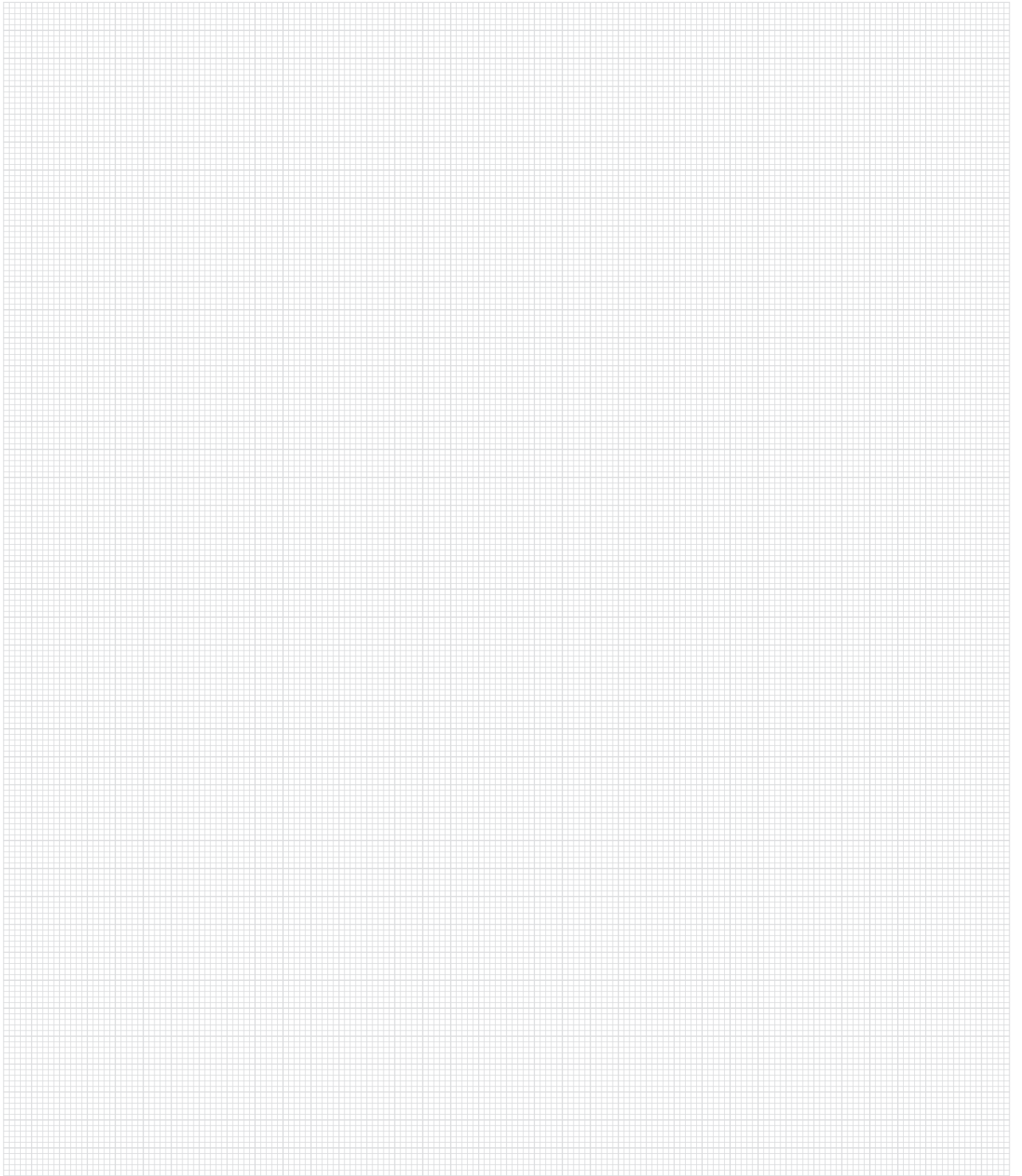

ARNO[®]
WERKZEUGE

Weitere Informationen finden Sie unter:
For more information see:

www.arno.de

ARNO[®]

WERKZEUGE

We have a passion for precision.

AUSFÜHRUNG AFV

Design AFV

Der Allrounder fürs Schrappen und Schlichten.

**General purpose high performance
for roughing and finishing.**

VHM-Schaftfräser mit ungleicher Drallsteigung von 35° bis 38° sind für die Bearbeitung fast aller Werkstoffe geeignet – bei 60% höherem Vorschub, vibrationsfreiem Lauf, besserer Oberflächengüte und größeren Schnitttiefen.



Solid carbide cutters with uneven pitch design (26°-30° or 35°-38°) for both roughing and finishing of nearly all materials with up to 60% higher feed rate, less vibration, better surface finish and increased cutting depth.

VHM-Schaftfräser mit ungleicher Drallsteigung

4 Schneiden, kurze Ausführung

Solid carbide end-mill with unequal pitch

4 flutes, short design

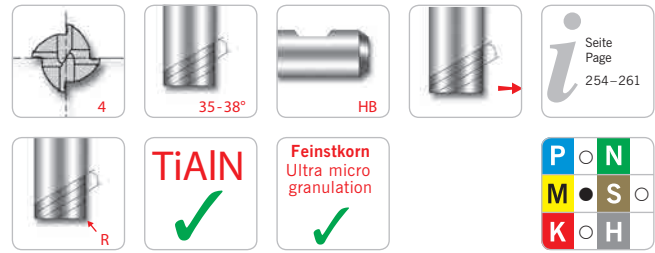

AFV61840-...(R...)

Schaft / Shank DIN 6535HB	d	d _A	l ₁	l	R
AFV61840-030	3,0	6	7	54	-
AFV61840-030R0,3	3,0	6	7	54	0,30
AFV61840-040	4,0	6	8	54	-
AFV61840-040R0,3	4,0	6	8	54	0,30
AFV61840-050	5,0	6	10	54	-
AFV61840-050R0,3	5,0	6	10	54	0,30
AFV61840-060	6,0	6	10	54	-
AFV61840-060R0,5	6,0	6	10	54	0,50
AFV61840-080	8,0	8	12	58	-
AFV61840-080R0,5	8,0	8	12	58	0,50
AFV61840-100	10,0	10	14	66	-
AFV61840-100R0,5	10,0	10	14	66	0,50
AFV61840-120	12,0	12	16	73	-
AFV61840-120R0,7	12,0	12	16	73	0,70
AFV61840-140	14,0	14	18	75	-
AFV61840-140R0,7	14,0	14	18	75	0,70
AFV61840-160	16,0	16	22	82	-
AFV61840-160R1,0	16,0	16	22	82	1,00
AFV61840-180	18,0	18	24	84	-
AFV61840-180R1,0	18,0	18	24	84	1,00
AFV61840-200	20,0	20	26	92	-
AFV61840-200R1,0	20,0	20	26	92	1,00

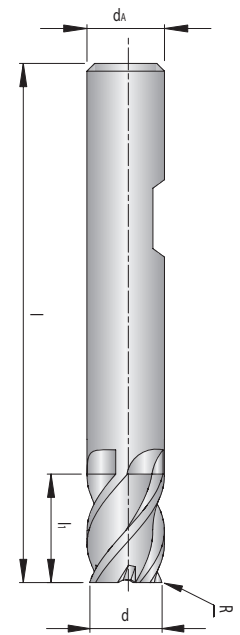

Toleranz / Tolerance	
Fräser / Mill	0 -0,03
Schaft / Shank	h6

AFV

● = Hauptanwendung / Main application
○ = Nebenanwendung / Suitable

Alle Angaben in mm / Dimensions in mm

VHM-Schaftfräser mit ungleicher Drallsteigung

4 Schneiden, kurze Ausführung

Solid carbide end-mill with unequal pitch

4 flutes, short design



N NEU/NEW

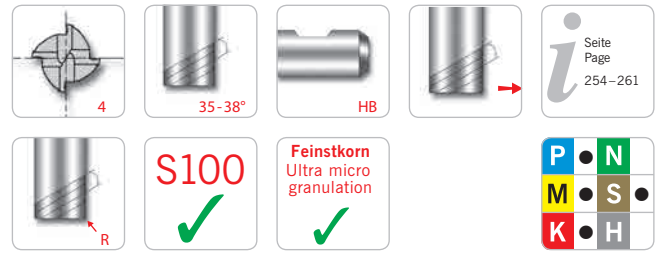

AFV61840-...(R...)

Schaft / Shank DIN 6535HB	d	d _A	l ₁	l	R
AFV61840-030 N	3,0	6	7	54	-
AFV61840-030R0,3 N	3,0	6	7	54	0,30
AFV61840-040 N	4,0	6	8	54	-
AFV61840-040R0,3 N	4,0	6	8	54	0,30
AFV61840-050 N	5,0	6	10	54	-
AFV61840-050R0,3 N	5,0	6	10	54	0,30
AFV61840-060 N	6,0	6	10	54	-
AFV61840-060R0,3 N	6,0	6	10	54	0,30
AFV61840-060R0,5 N	6,0	6	10	54	0,50
AFV61840-080 N	8,0	8	12	58	-
AFV61840-080R0,5 N	8,0	8	12	58	0,50
AFV61840-100 N	10,0	10	14	66	-
AFV61840-100R0,5 N	10,0	10	14	66	0,50
AFV61840-120 N	12,0	12	16	73	-
AFV61840-120R0,5 N	12,0	12	16	73	0,50
AFV61840-140 N	14,0	14	18	75	-
AFV61840-140R0,5 N	14,0	14	18	75	0,50
AFV61840-160 N	16,0	16	22	82	-
AFV61840-160R1,0 N	16,0	16	22	82	1,00
AFV61840-180 N	18,0	18	24	84	-
AFV61840-180R1,0 N	18,0	18	24	84	1,00
AFV61840-200 N	20,0	20	26	92	-
AFV61840-200R1,0 N	20,0	20	26	92	1,00

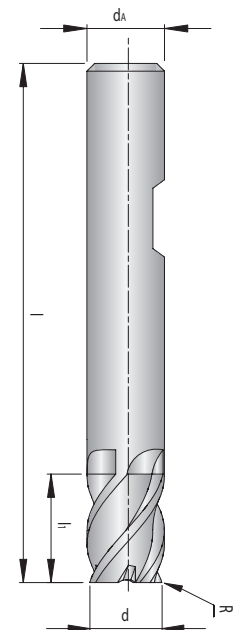

AFV

Toleranz / Tolerance	
Fräser / Mill	0 -0,03
Schaft / Shank	h6

● = Hauptanwendung / Main application
○ = Nebenanwendung / Suitable

Alle Angaben in mm / Dimensions in mm

VHM-Schaftfräser mit ungleicher Drallsteigung

4 Schneiden, kurze Ausführung

Solid carbide end-mill with unequal pitch

4 flutes, short design



4

35-38°

HB

Seite
Page
254-261

S100

Feinstkorn
Ultra micro
granulation

P	N
M	S
K	H

AFV62342-...

Schaft / Shank DIN 6535HB	d	d _A	l ₁	l ₂	l
AFV62342-030A N	3,0	6	7	12	54
AFV62342-030B N	3,0	6	7	17	57
AFV62342-030C N	3,0	6	8	14	57
AFV62342-040A N	4,0	6	8	15	57
AFV62342-040B N	4,0	6	8	22	63
AFV62342-040C N	4,0	6	11	16	57
AFV62342-050A N	5,0	6	10	17	57
AFV62342-050B N	5,0	6	10	27	67
AFV62342-050C N	5,0	6	13	18	57
AFV62342-060A N	6,0	6	10	15	57
AFV62342-060B N	6,0	6	10	20	62
AFV62342-060C N	6,0	6	10	32	74
AFV62342-060D N	6,0	6	13	21	57
AFV62342-080A N	8,0	8	12	20	63
AFV62342-080B N	8,0	8	12	30	73
AFV62342-080C N	8,0	8	19	27	63
AFV62342-080D N	8,0	8	12	46	90
AFV62342-100A N	10,0	10	14	25	72
AFV62342-100B N	10,0	10	14	35	82
AFV62342-100C N	10,0	10	22	32	72
AFV62342-100D N	10,0	10	14	55	102
AFV62342-120A N	12,0	12	16	30	83
AFV62342-120B N	12,0	12	16	40	93
AFV62342-120C N	12,0	12	26	38	83
AFV62342-120D N	12,0	12	16	64	117
AFV62342-160A N	16,0	16	22	38	92
AFV62342-160B N	16,0	16	32	44	92
AFV62342-160C N	16,0	16	22	55	109
AFV62342-160D N	16,0	16	22	87	141
AFV62342-200A N	20,0	20	26	50	104
AFV62342-200B N	20,0	20	38	54	104
AFV62342-200C N	20,0	20	26	70	124
AFV62342-200D N	20,0	20	26	110	164

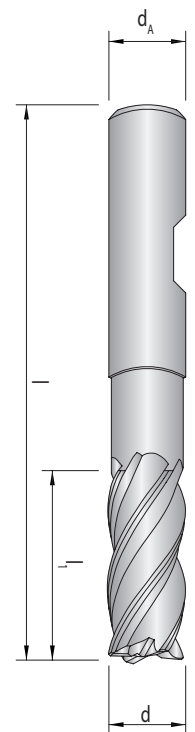

Toleranz / Tolerance	
Fräser / Mill	0 -0,03
Schaft / Shank	h6

AFV

● = Hauptanwendung / Main application
○ = Nebenanwendung / Suitable

Alle Angaben in mm / Dimensions in mm

VHM-Schaftfräser mit ungleicher Drallsteigung

4 Schneiden, kurze Ausführung, mit Eckenradius

Solid carbide end-mill with unequal pitch

4 flutes, short design, with corner radius

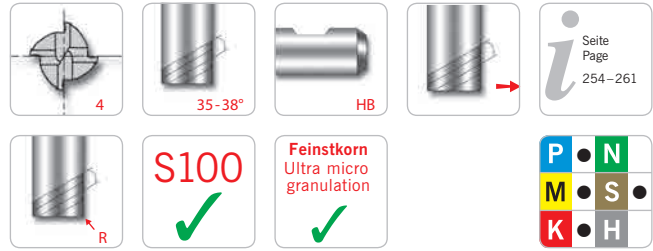

AFV62342-...(R...)

Schaft / Shank DIN 6535HB	d	d _A	l ₁	l ₂	l	R
AFV62342-030AR0,3 N	3,0	6	7	12	54	0,30
AFV62342-030BR0,3 N	3,0	6	7	17	57	0,30
AFV62342-040AR0,3 N	4,0	6	8	15	57	0,30
AFV62342-040BR0,3 N	4,0	6	8	22	63	0,30
AFV62342-050AR0,3 N	5,0	6	10	17	57	0,30
AFV62342-050BR0,3 N	5,0	6	10	27	67	0,30
AFV62342-060AR0,5 N	6,0	6	10	15	57	0,50
AFV62342-060BR0,5 N	6,0	6	10	20	62	0,50
AFV62342-060CR0,5 N	6,0	6	10	32	74	0,50
AFV62342-080AR0,5 N	8,0	8	12	20	63	0,50
AFV62342-080BR0,5 N	8,0	8	12	30	73	0,50
AFV62342-080CR0,5 N	8,0	8	12	46	90	0,50
AFV62342-100AR0,5 N	10,0	10	14	25	72	0,50
AFV62342-100BR0,5 N	10,0	10	14	35	82	0,50
AFV62342-100CR0,5 N	10,0	10	14	55	102	0,50
AFV62342-120AR0,5 N	12,0	12	16	30	83	0,50
AFV62342-120BR0,5 N	12,0	12	16	40	93	0,50
AFV62342-120CR0,5 N	12,0	12	16	64	117	0,50
AFV62342-160AR1,0 N	16,0	16	22	38	92	1,00
AFV62342-160BR1,0 N	16,0	16	22	55	109	1,00
AFV62342-160CR1,0 N	16,0	16	22	87	141	1,00
AFV62342-200AR1,0 N	20,0	20	26	50	104	1,00
AFV62342-200BR1,0 N	20,0	20	26	70	124	1,00
AFV62342-200CR1,0 N	20,0	20	26	110	164	1,00

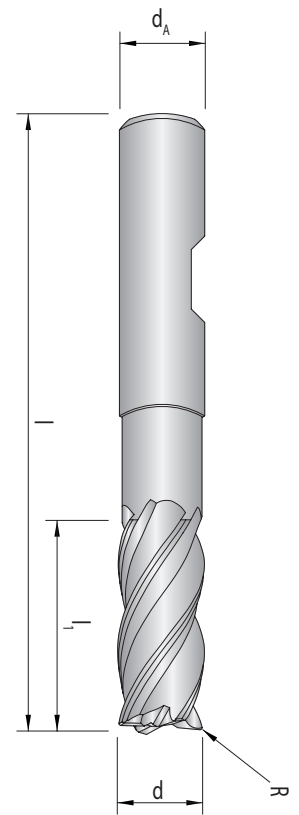

AFV

Toleranz / Tolerance	
Fräser / Mill	0 -0,03
Schaft / Shank	h6

● = Hauptanwendung / Main application
○ = Nebenanwendung / Suitable

Alle Angaben in mm / Dimensions in mm

VHM-Schaftfräser mit ungleicher Drallsteigung

4 Schneiden, lange Ausführung

Solid carbide end-mill with unequal pitch

4 flutes, long design

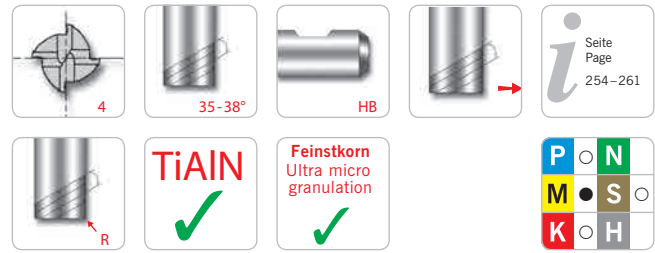

AFV61841-...(R...)

Schaft / Shank DIN 6535HB	d	d _A	l ₁	l	R
AFV61841-030	3,0	6	8	57	-
AFV61841-030R0,3	3,0	6	8	57	0,30
AFV61841-040	4,0	6	11	57	-
AFV61841-040R0,3	4,0	6	11	57	0,30
AFV61841-050	5,0	6	13	57	-
AFV61841-050R0,3	5,0	6	13	57	0,30
AFV61841-060	6,0	6	13	57	-
AFV61841-060R0,5	6,0	6	13	57	0,50
AFV61841-080	8,0	8	19	63	-
AFV61841-080R0,5	8,0	8	19	63	0,50
AFV61841-100	10,0	10	22	72	-
AFV61841-100R0,5	10,0	10	22	72	0,50
AFV61841-100R1,5	10,0	10	22	72	1,50
AFV61841-100R3,0	10,0	10	22	72	3,00
AFV61841-120	12,0	12	26	83	-
AFV61841-120R0,7	12,0	12	26	83	0,70
AFV61841-140	14,0	14	26	83	-
AFV61841-140R0,7	14,0	14	26	83	0,70
AFV61841-160	16,0	16	32	92	-
AFV61841-160R1,0	16,0	16	32	92	1,00
AFV61841-160R1,5	16,0	16	32	92	1,50
AFV61841-160R2,0	16,0	16	32	92	2,00
AFV61841-160R3,0	16,0	16	32	92	3,00
AFV61841-180	18,0	18	32	92	-
AFV61841-180R1,0	18,0	18	32	92	1,00
AFV61841-200	20,0	20	38	104	-
AFV61841-200R1,0	20,0	20	38	104	1,00
AFV61841-200R2,0	20,0	20	38	104	2,00
AFV61841-200R3,0	20,0	20	38	104	3,00
AFV61841-250	25,0	25	38	104	-
AFV61841-250R1,0	25,0	25	38	104	1,00
AFV61841-250R3,0	25,0	25	38	104	3,00

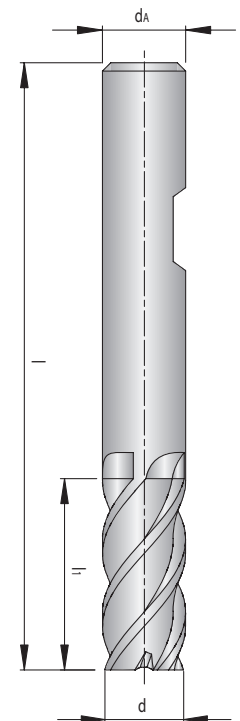

Toleranz / Tolerance	
Fräser / Mill	⁰ -0,03
Schaft / Shank	h6

AFV

● = Hauptanwendung / Main application
○ = Nebenanwendung / Suitable

VHM-Schaftfräser mit ungleicher Drillsteigung

4 Schneiden, lange Ausführung

Solid carbide end-mill with unequal pitch

4 flutes, long design

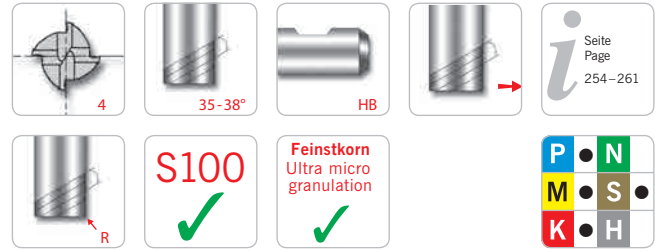

AFV61841-...(R...)

Schaft / Shank DIN 6535HB	d	d _A	l ₁	l	R
AFV61841-030 N	3,0	6	8	57	-
AFV61841-030R0,3 N	3,0	6	8	57	0,30
AFV61841-040 N	4,0	6	11	57	-
AFV61841-040R0,3 N	4,0	6	11	57	0,30
AFV61841-050 N	5,0	6	13	57	-
AFV61841-050R0,3 N	5,0	6	13	57	0,30
AFV61841-060 N	6,0	6	13	57	-
AFV61841-060R0,3 N	6,0	6	13	57	0,30
AFV61841-060R0,5 N	6,0	6	13	57	0,50
AFV61841-060R1,0 N	6,0	6	13	57	1,00
AFV61841-080 N	8,0	8	19	63	-
AFV61841-080R0,5 N	8,0	8	19	63	0,50
AFV61841-080R1,0 N	8,0	8	19	63	1,00
AFV61841-100 N	10,0	10	22	72	-
AFV61841-100R0,5 N	10,0	10	22	72	0,50
AFV61841-120 N	12,0	12	26	83	-
AFV61841-120R0,5 N	12,0	12	26	83	0,50
AFV61841-140 N	14,0	14	26	83	-
AFV61841-140R0,5 N	14,0	14	26	83	0,50
AFV61841-160 N	16,0	16	32	92	-
AFV61841-160R1,0 N	16,0	16	32	92	1,00
AFV61841-180 N	18,0	18	32	92	-
AFV61841-180R1,0 N	18,0	18	32	92	1,00
AFV61841-200 N	20,0	20	38	104	-
AFV61841-200R1,0 N	20,0	20	38	104	1,00
AFV61841-250 N	25,0	25	38	104	-
AFV61841-250R1,0 N	25,0	25	38	104	1,00

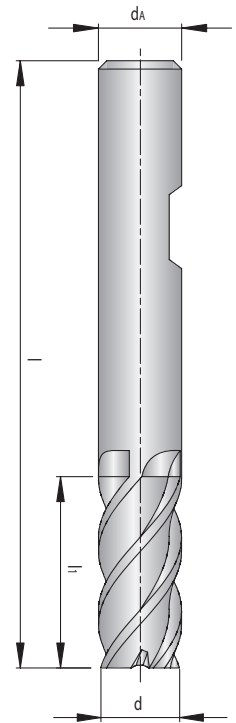

AFV

Toleranz / Tolerance	
Fräser / Mill	0 -0,03
Schaft / Shank	h6

● = Hauptanwendung / Main application
○ = Nebenanwendung / Suitable

Alle Angaben in mm / Dimensions in mm

VHM-Radiusfräser mit ungleicher Drallsteigung

4 Schneiden, lange Ausführung

Solid carbide ball-nose end-mill with unequal pitch

4 flutes, long design

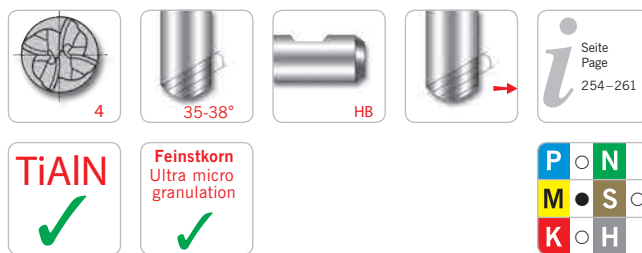

AFV60341-...

Schaft / Shank DIN 6535HB	d	d _A	l ₁	l
AFV60341-030	3,0	6	8	57
AFV60341-040	4,0	6	11	57
AFV60341-050	5,0	6	13	57
AFV60341-060	6,0	6	13	57
AFV60341-080	8,0	8	19	63
AFV60341-100	10,0	10	22	72
AFV60341-120	12,0	12	26	83
AFV60341-160	16,0	16	32	92
AFV60341-200	20,0	20	38	104
AFV60341-250	25,0	25	38	104

Toleranz / Tolerance	
Fräser / Mill	0 -0,03
Radius / Radius	± 0,01
Schaft / Shank	h6

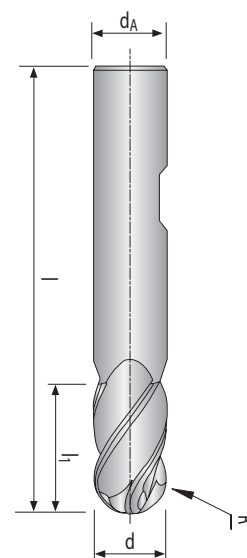

AFV

VHM-Schaftfräser mit ungleicher Drallsteigung

5 Schneiden, lange Ausführung



Solid carbide end-mill with unequal pitch

5 flutes, long design

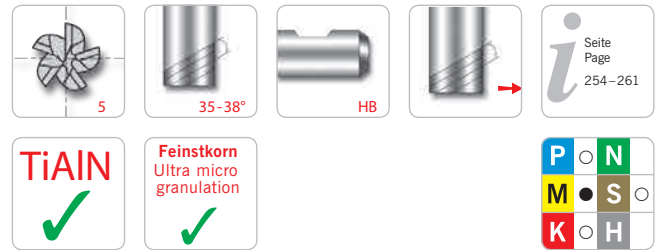

AFV61851-...

Schaft / Shank DIN 6535HB	d	d _A	l ₁	l
AFV61851-060	6,0	6	13	57
AFV61851-080	8,0	8	19	63
AFV61851-100	10,0	10	22	72
AFV61851-120	12,0	12	26	83
AFV61851-140	14,0	14	26	83
AFV61851-160	16,0	16	32	92
AFV61851-180	18,0	18	32	92
AFV61851-200	20,0	20	38	104
AFV61851-250	25,0	25	38	104

Toleranz / Tolerance

Fräser / Mill	0 -0,03
Schaft / Shank	h6

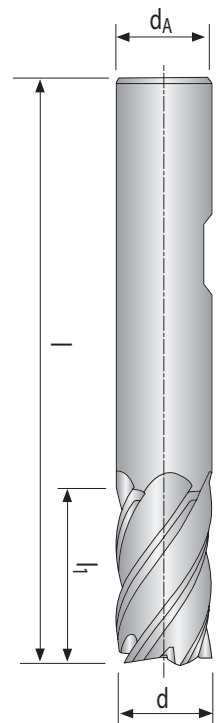

AFV

● = Hauptanwendung / Main application
○ = Nebenanwendung / Suitable

Alle Angaben in mm / Dimensions in mm

Empfohlene Schnittwerte VHM-Schafffräser

Ausführung AFV

ISO	Werkstoff	Festigkeit [N/mm ²]	Vorschub-Korrekturfaktor [$\times f_z$]	Schrupp- und Nutfräsen				Schlicht- und Konturfräsen					
				AlTiN	TiAlN	TiCN	Tia70	AlTiN	TiAlN	TiCN	Tia70		
				V_c [m/min]	V_c [m/min]	V_c [m/min]	V_c [m/min]	V_c [m/min]	V_c [m/min]	V_c [m/min]	V_c [m/min]		
P	Allgemeiner Baustahl	< 800	1,2		100-150				200-240				
	Automatenstahl	< 800	1,2		100-150				200-240				
	Einsatzstahl, unlegiert	< 800	1,2		100-150				200-240				
	Einsatzstahl, legiert	< 1000	1		90-120				170-200				
	Vergütungsstahl, unlegiert	< 850	1,2		90-130				180-220				
	Vergütungsstahl, unlegiert	< 1000	1		60-90				100-140				
	Vergütungsstahl, legiert	< 800	1,2		90-120				170-200				
	Vergütungsstahl, legiert	< 1300	0,8		60-80				90-120				
	Stahlguss	< 850	1,2		70-100				150-180				
	Nitrierstahl	< 1000	1		80-90				100-140				
	Nitrierstahl	< 1200	0,8		60-80				90-120				
	Wälzlagerstahl	< 1200	0,8		60-90				100-140				
	Federstahl	< 1200	0,8		40-60				90-120				
	Schnellarbeitsstahl	< 1300	0,8		40-50				40-50				
Werkzeugstahl für Kaltarbeit	< 1300	0,8		60-70				90-110					
Werkzeugstahl für Warmarbeit	< 1300	0,8		60-70				90-110					
M	Stahl und Stahlguss, rostfrei geschwefelt	< 850	1		60-80				85-120				
	Nichtrostender Stahl, ferritisch	< 750	1		50-70				85-120				
	Nichtrostender Stahl, martensitisch	< 900	1		40-60				70-100				
	Nichtrostender Stahl, ferritisch/martensitisch	< 1100	0,9		30-40				60-80				
	Nichtrostender Stahl, austenitisch/ferritisch	< 850	1		50-70				80-120				
	Nichtrostender Stahl, austenitisch	< 750	1		60-80				80-120				
Hitzebeständig	< 1100	0,9		30-40				60-80					
K	Grauguss mit Lammellengraphit	100-350	1		80-100				140-160				
	Grauguss mit Lammellengraphit	300-1000	1		70-90				120-150				
	Kugelgraphitguss	300-500	1		80-100				140-160				
	Kugelgraphitguss	550-800	1		70-90				120-150				
	Temperguss, weiß	350-450	1		80-100				140-160				
	Temperguss, weiß	500-650	1		70-90				120-150				
	Temperguss, schwarz	350-450	1		80-100				140-160				
	Temperguss, schwarz	500-700	0,8		70-90				120-150				
N	Aluminium (unlegiert, niedrig legiert)	< 350											
	Aluminiumlegierungen < 0,5% Si	< 500											
	Aluminiumlegierungen 0,5 - 10% Si	< 400											
	Aluminiumlegierungen 10 - 15% Si	< 400											
	Aluminiumlegierungen > 15% Si	< 400											
	Kupfer (unlegiert, niedrig legiert)	< 350											
	Kupfer-Knetlegierungen	< 700											
	Kupfer-Sonderlegierungen	< 200 HB											
	Kupfer-Sonderlegierungen	< 300 HB											
	Kupfer-Sonderlegierungen	> 300 HB											
	Messing kurzspanend, Bronze, Rotguss	< 600											
	Messing langspanend	< 600											
	Thermoplaste												
	Duroplaste												
	Faserverstärkte Kunststoffe												
Magnesium und Magnesiumlegierungen	< 850												
Graphit													
Wolfram und Wolframlegierungen													
Molybdän und Molybdänlegierungen													
S	Reinnickel		1,1		40-50				60-90				
	Nickellegierungen		1		30-40				40-70				
	Nickellegierungen	< 850	1,1		50-70				70-100				
	Nickel-Chromlegierungen		0,9		40-60				60-90				
	Nickel- und Kobaltlegierungen	< 1300	0,7		30-50				50-80				
	Hochwarmfeste Legierungen	< 1300	0,7		30-50				60-90				
	Nickel-Kobalt-(Chrom-)legierungen	< 1400	0,9		30-40				50-70				
	Nickel- und Kobaltlegierungen	< 1300	1		30-50				50-70				
	Reintitan	< 900	1		50-70				90-120				
	Titanlegierungen	< 700	1,1		60-80				100-130				
Titanlegierungen	< 1200	1		40-50				90-110					
H	Stahl gehärtet	< 45 HRC											
		46-55 HRC											
		56-60 HRC											
		61-65 HRC											
		65-70 HRC											

Die Tabellenwerte sind Richtwerte. Es kann notwendig sein, die Werte den jeweiligen Bearbeitungsumständen anzupassen.

Recommended cutting data Solid carbide end-mill

Design AFV

ISO	Material	Strength [N/mm ²]	Correction factor [x f _c]	Roughing and full slot milling				Peripheral- and contour milling				
				AlTiN	TiAlN	TiCN	Tia70	AlTiN	TiAlN	TiCN	Tia70	
				V _c [m/min]	V _c [m/min]	V _c [m/min]	V _c [m/min]	V _c [m/min]	V _c [m/min]	V _c [m/min]	V _c [m/min]	
P	General construction steel	< 800	1,2		100-150				200-240			
	Free cutting steel	< 800	1,2		100-150				200-240			
	Case hardened steel, non alloyed	< 800	1,2		100-150				200-240			
	Alloyed case hardened steel	< 1000	1		90-120				170-200			
	Tempering steel, non alloyed	< 850	1,2		90-130				180-220			
	Tempering steel, non alloyed	< 1000	1		60-90				100-140			
	Tempering steel, alloyed	< 800	1,2		90-120				170-200			
	Tempering steel, alloyed	< 1300	0,8		60-80				90-120			
	Steel castings	< 850	1,2		70-100				150-180			
	Nitriding steel	< 1000	1		80-90				100-140			
	Nitriding steel	< 1200	0,8		60-80				90-120			
	Roller bearing steel	< 1200	0,8		60-90				100-140			
	Spring steel	< 1200	0,8		40-60				90-120			
	High-speed steel	< 1300	0,8		40-50				40-50			
Cold working tool steel	< 1300	0,8		60-70				90-110				
Hot working tool steel	< 1300	0,8		60-70				90-110				
M	Steel and sulphured cast stainless steel	< 850	1		60-80				85-120			
	Stainless steel, ferritic	< 750	1		50-70				85-120			
	Stainless steel, martensitic	< 900	1		40-60				70-100			
	Stainless steel, ferritic/martensitic	< 1100	0,9		30-40				60-80			
	Stainless steel, austenitic/ferritic	< 850	1		50-70				80-120			
	Stainless steel, austenitic	< 750	1		60-80				80-120			
	Heat resistant steel	< 1100	0,9		30-40				60-80			
K	Grey cast iron with lamellar graphite	100-350	1		80-100				140-160			
	Grey cast iron with lamellar graphite	300-1000	1		70-90				120-150			
	Spheroidal cast iron	300-500	1		80-100				140-160			
	Spheroidal cast iron	550-800	1		70-90				120-150			
	White cast iron, tempered	350-450	1		80-100				140-160			
	White cast iron, tempered	500-650	1		70-90				120-150			
	Black cast iron, tempered	350-450	1		80-100				140-160			
	Black cast iron, tempered	500-700	0,8		70-90				120-150			
N	Aluminium (non alloyed, low alloyed)	< 350										
	Aluminium alloys < 0,5% Si	< 500										
	Aluminium alloys 0,5% - 10% Si	< 400										
	Aluminium alloys 10% - 15% Si	< 400										
	Aluminium alloys > 15% Si	< 400										
	Copper (non alloyed, low alloyed)	< 350										
	Copper wrought alloys	< 700										
	Special copper alloys	< 200 HB										
	Special copper alloys	< 300 HB										
	Special copper alloys	> 300 HB										
	Short-chipping brass, bronze, red bronze	< 600										
	Long-chipping brass	< 600										
	Thermoplastics											
	Duroplastics											
	Fibre-reinforced plastics											
	Magnesium and magnesium alloys	< 850										
Graphite												
Tungsten and tungsten alloys												
Molybdenum and molybdenum alloys												
S	Pure nickel		1,1		40-50				60-90			
	Nickel alloys		1		30-40				40-70			
	Nickel alloys	< 850	1,1		50-70				70-100			
	Nickel-chromium alloys		0,9		40-60				60-90			
	Nickel and cobalt alloys	< 1300	0,7		30-50				50-80			
	Nickel and cobalt alloys	< 1300	0,7		30-50				60-90			
	Heat resistant alloys	< 1400	0,9		30-40				50-70			
	Nickel-cobalt-chromium alloys	< 1300	1		30-50				50-70			
	Pure titanium	< 900	1		50-70				90-120			
	Titanium alloys	< 700	1,1		60-80				100-130			
Titanium alloys	< 1200	1		40-50				90-110				
H	Tempered steel	< 45 HRC										
		46-55 HRC										
		56-60 HRC										
		61-65 HRC										
		65-70 HRC										

The recommended cutting data are only approximate values. It may be necessary to adjust them to each individual machining application.

Für die nachfolgenden Vorschub-Richtwerte müssen die Werte je nach zu bearbeitendem Material gemäß dem in den Schnittgeschwindigkeitstabellen angegebenen Korrekturfaktor $K_f [f_z]$ korrigiert werden.

For the following feed tables the values must be corrected depending on the material being machined in line with the correction factor $K_f [f_z]$.

Beispiel für Fräser mit Schneidendurchmesser 6 mm:

An example using a cutter with \varnothing 6 mm is detailed:

Schnittgeschwindigkeits-Tabelle / V_c -table

ISO	Werkstoff / Material	Festigkeit Strength [N/mm ² - HB]	$K_f [x f_z]$	TiAlN V_c [m/min]
P	Allgemeiner Baustahl General construction steel	< 800 N/mm ²	1,2	100 - 150
	Automatenstahl Free cutting steel	< 800 N/mm ²	1,2	100 - 150
	Einsatzstahl, unlegiert Case hardened steel, non alloyed	< 800 N/mm ²	1,2	100 - 150
	Einsatzstahl, legiert Alloyed case hardened steel	< 1000 N/mm ²	1	90 - 120
	Vergütungsstahl, unlegiert Tempering steel, non alloyed	< 850 N/mm ²	1,2	90 - 130
	Vergütungsstahl, unlegiert Tempering steel, non alloyed	< 1000 N/mm ²	1	60 - 90
	Vergütungsstahl, legiert Tempering steel, alloyed	< 800 N/mm ²	1,2	90 - 120
	Vergütungsstahl, legiert Tempering steel, alloyed	< 1300 N/mm ²	0,8	60 - 80
	Stahlguss Steel castings	< 850 N/mm ²	1,2	70 - 100

Korrekturfaktor-Tabelle / f_z -table

$\varnothing d_1$ [mm]	Korrekturfaktor/ Correction factor $K_f [f_z]$		
	1	0,7	0,8
1	0,004	0,003	0,003
2	0,008	0,006	0,006
3	0,012	0,008	0,010
4	0,016	0,011	0,013
5	0,020	0,014	0,016
6	0,024	0,017	0,019
8	0,032	0,022	0,026

Für legierten Einsatzstahl gilt der Vorschubwert aus der Korrekturfaktor-Tabelle.

$K_f (f_z) = 1$ (entsprechend 100%) $f_z = 0,024$

Für legierten Vergütungsstahl < 1300 N/mm² wird der Vorschubwert aus der Korrekturfaktor-Tabelle um 20% reduziert.

$K_f (f_z) = 0,8$ (entsprechend 80%) $f_z = 0,019$

For case-hardening alloy steel the feed value from the table is valid:

$K_f (f_z) = 1$ (according to 100%) $f_z = 0,024$

For heat treatable steel alloys < 1300 N/mm² the feed value from the table is reduced by 20%.

$K_f (f_z) = 0,8$ (according to 80%) $f_z = 0,019$

Generelle Berechnungsformeln / General rule:

Vorschub pro Zahn / Feed per tooth: $= f_z \cdot K_f (f_z)$

Bohrvorschub (Fräsen in axialer Richtung): = Tabellenwert / Zähnezahl

For axial plunge milling: = Table value / Number of teeth

Vorschub pro Zahn bei einer radialen Zustellung von 0,2 – 0,3 mm

Feed per tooth with radial depth of cut from 0,2 – 0,3 mm

Ø d ₁ [mm]	Korrekturfaktor / Correction factor Kf [f _z]									
	1	0,7	0,8	0,9	1,1	1,2	1,5	1,6	1,8	1,9
1	0,004	0,003	0,003	0,004	0,004	0,005	0,006	0,006	0,007	0,008
2	0,008	0,006	0,006	0,007	0,009	0,010	0,012	0,013	0,014	0,015
3	0,012	0,008	0,010	0,011	0,013	0,014	0,018	0,019	0,022	0,023
4	0,016	0,011	0,013	0,014	0,018	0,019	0,024	0,026	0,029	0,030
5	0,020	0,014	0,016	0,018	0,022	0,024	0,030	0,032	0,036	0,038
6	0,024	0,017	0,019	0,022	0,026	0,029	0,036	0,038	0,043	0,046
8	0,032	0,022	0,026	0,029	0,035	0,038	0,048	0,051	0,058	0,061
10	0,040	0,028	0,032	0,036	0,044	0,048	0,060	0,064	0,072	0,076
12	0,048	0,034	0,038	0,043	0,053	0,058	0,072	0,077	0,086	0,091
14	0,056	0,039	0,045	0,050	0,062	0,067	0,084	0,090	0,101	0,106
16	0,064	0,045	0,051	0,058	0,070	0,077	0,096	0,102	0,115	0,122
18	0,072	0,050	0,058	0,065	0,079	0,086	0,108	0,115	0,130	0,137
20	0,080	0,056	0,064	0,072	0,088	0,096	0,120	0,128	0,144	0,152
25	0,100	0,070	0,080	0,090	0,110	0,120	0,150	0,160	0,180	0,190

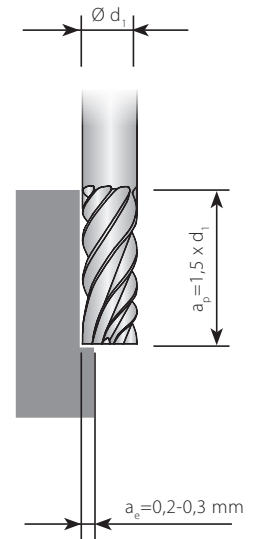

Vorschub pro Zahn bei einer radialen Zustellung 10% vom Schneidendurchmesser (Ø d₁)

Feed per tooth with radial depth of cut of 10% of the cutter (Ø d₁)

Ø d ₁ [mm]	Korrekturfaktor / Correction factor Kf [f _z]									
	1	0,7	0,8	0,9	1,1	1,2	1,5	1,6	1,8	1,9
1	0,003	0,002	0,002	0,003	0,003	0,004	0,005	0,005	0,005	0,006
2	0,008	0,006	0,006	0,007	0,009	0,010	0,012	0,013	0,014	0,015
3	0,012	0,008	0,010	0,011	0,013	0,014	0,018	0,019	0,022	0,023
4	0,014	0,010	0,011	0,013	0,015	0,017	0,021	0,022	0,025	0,027
5	0,017	0,012	0,014	0,015	0,019	0,020	0,026	0,027	0,031	0,032
6	0,020	0,014	0,016	0,018	0,022	0,024	0,030	0,032	0,036	0,038
8	0,027	0,019	0,022	0,024	0,030	0,032	0,041	0,043	0,049	0,051
10	0,033	0,023	0,026	0,030	0,036	0,040	0,050	0,053	0,059	0,063
12	0,040	0,028	0,032	0,036	0,044	0,048	0,060	0,064	0,072	0,076
14	0,047	0,033	0,038	0,042	0,052	0,056	0,071	0,075	0,085	0,089
16	0,053	0,037	0,042	0,048	0,058	0,064	0,080	0,085	0,095	0,101
18	0,060	0,042	0,048	0,054	0,066	0,072	0,090	0,096	0,108	0,114
20	0,067	0,047	0,054	0,060	0,074	0,080	0,101	0,107	0,121	0,127
25	0,083	0,058	0,066	0,075	0,091	0,100	0,125	0,133	0,149	0,158

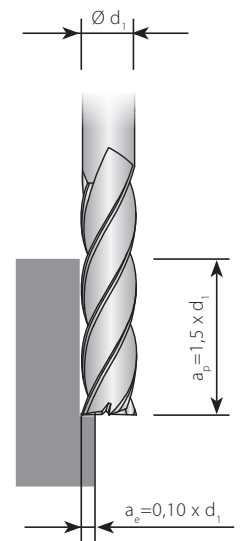

Achtung:

Vorschub-Korrekturfaktor → Kf f_z = 1,10 bei a_p = 1 x d₁ und → Kf f_z = 1,25 bei a_p = 0,5 x d₁
Für unbeschichtete Werkzeuge ist der Vorschub um 10-20% zu reduzieren.

Attention:

Feed rate correction factor → Kf f_z = 1,10 with a_p = 1 x d₁ and → Kf f_z = 1,25 with a_p = 0,5 x d₁
Feed rates are reduced by 10-20% for uncoated tools.

Vorschub pro Zahn bei einer radialen Zustellung 20% vom Schneidendurchmesser ($\varnothing d_1$)
 Feed per tooth with radial depth of cut of 20% of the cutter ($\varnothing d_1$)

$\varnothing d_1$ [mm]	Korrekturfaktor / Correction factor $K_f [f_z]$									
	1	0,7	0,8	0,9	1,1	1,2	1,5	1,6	1,8	1,9
1	0,002	0,001	0,001	0,001	0,002	0,002	0,003	0,003	0,003	0,003
2	0,005	0,003	0,004	0,004	0,005	0,006	0,007	0,008	0,009	0,009
3	0,008	0,005	0,006	0,007	0,008	0,009	0,012	0,012	0,014	0,015
4	0,010	0,007	0,008	0,009	0,011	0,012	0,015	0,016	0,018	0,019
5	0,013	0,009	0,010	0,011	0,014	0,015	0,019	0,020	0,023	0,024
6	0,015	0,010	0,012	0,013	0,016	0,018	0,022	0,024	0,027	0,028
8	0,020	0,014	0,016	0,018	0,022	0,024	0,030	0,032	0,036	0,038
10	0,025	0,017	0,020	0,022	0,027	0,030	0,037	0,040	0,045	0,047
12	0,030	0,021	0,024	0,027	0,033	0,036	0,045	0,048	0,054	0,057
14	0,035	0,024	0,028	0,031	0,038	0,042	0,052	0,056	0,063	0,066
16	0,040	0,028	0,032	0,036	0,044	0,048	0,060	0,064	0,072	0,076
18	0,045	0,031	0,036	0,040	0,049	0,054	0,067	0,072	0,081	0,085
20	0,050	0,035	0,040	0,045	0,055	0,060	0,075	0,080	0,090	0,095
25	0,063	0,044	0,050	0,056	0,069	0,075	0,094	0,100	0,113	0,119

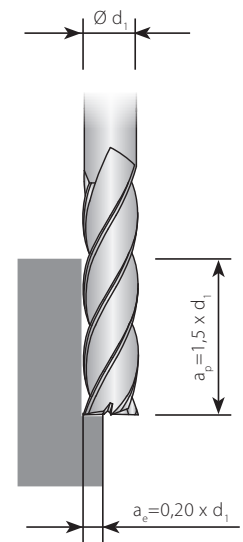

Vorschub pro Zahn bei einer radialen Zustellung 40% vom Schneidendurchmesser ($\varnothing d_1$)
 Feed per tooth with radial depth of cut of 40% of the cutter ($\varnothing d_1$)

$\varnothing d_1$ [mm]	Korrekturfaktor / Correction factor $K_f [f_z]$									
	1	0,7	0,8	0,9	1,1	1,2	1,5	1,6	1,8	1,9
1	0,001	0,001	0,001	0,001	0,001	0,001	0,002	0,002	0,002	0,003
2	0,004	0,002	0,003	0,003	0,004	0,004	0,006	0,006	0,007	0,007
3	0,006	0,004	0,005	0,005	0,007	0,007	0,009	0,010	0,011	0,012
4	0,008	0,005	0,006	0,007	0,008	0,009	0,012	0,012	0,014	0,015
5	0,010	0,007	0,008	0,009	0,011	0,012	0,015	0,016	0,018	0,019
6	0,012	0,008	0,009	0,010	0,013	0,014	0,018	0,019	0,021	0,022
8	0,016	0,011	0,012	0,014	0,017	0,019	0,024	0,025	0,028	0,030
10	0,020	0,014	0,016	0,018	0,022	0,024	0,030	0,032	0,036	0,038
12	0,024	0,016	0,019	0,021	0,026	0,028	0,036	0,038	0,043	0,045
14	0,028	0,019	0,022	0,025	0,030	0,033	0,042	0,044	0,050	0,053
16	0,032	0,022	0,025	0,028	0,035	0,038	0,048	0,051	0,057	0,060
18	0,036	0,025	0,028	0,032	0,039	0,043	0,054	0,057	0,064	0,068
20	0,040	0,028	0,032	0,036	0,044	0,048	0,060	0,064	0,072	0,076
25	0,050	0,035	0,040	0,045	0,055	0,060	0,075	0,080	0,090	0,095

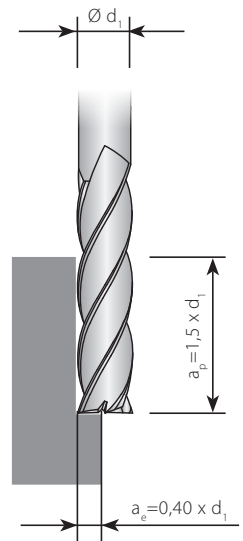

Achtung:
 Vorschub-Korrekturfaktor $K_f f_z = 1,10$ bei $a_p = 1 \times d_1$ und $K_f f_z = 1,25$ bei $a_p = 0,5 \times d_1$
 Für unbeschichtete Werkzeuge ist der Vorschub um 10-20% zu reduzieren.

Attention:
 Feed rate correction factor $K_f f_z = 1,10$ with $a_p = 1 \times d_1$ and $K_f f_z = 1,25$ with $a_p = 0,5 \times d_1$
 Feed rates are reduced by 10-20% for uncoated tools.

Vorschub pro Zahn bei einer radialen Zustellung 60% vom Schneidendurchmesser ($\varnothing d_1$)
 Feed per tooth with radial depth of cut of 60% of the cutter ($\varnothing d_1$)

$\varnothing d_1$ [mm]	Korrekturfaktor / Correction factor $K_f [f_z]$									
	1	0,7	0,8	0,9	1,1	1,2	1,5	1,6	1,8	1,9
1	0,001	0,001	0,001	0,001	0,001	0,001	0,001	0,002	0,002	0,002
2	0,003	0,002	0,002	0,002	0,003	0,003	0,004	0,005	0,005	0,006
3	0,005	0,003	0,004	0,004	0,005	0,006	0,007	0,008	0,009	0,009
4	0,006	0,004	0,005	0,005	0,007	0,007	0,009	0,010	0,011	0,012
5	0,008	0,005	0,006	0,007	0,009	0,010	0,012	0,013	0,015	0,016
6	0,009	0,006	0,007	0,008	0,010	0,011	0,014	0,015	0,017	0,018
8	0,013	0,009	0,010	0,011	0,014	0,015	0,019	0,020	0,023	0,024
10	0,016	0,011	0,013	0,014	0,017	0,019	0,024	0,026	0,029	0,030
12	0,019	0,013	0,015	0,017	0,021	0,023	0,029	0,031	0,035	0,037
14	0,022	0,015	0,018	0,020	0,025	0,027	0,034	0,036	0,040	0,043
16	0,026	0,018	0,020	0,023	0,028	0,031	0,039	0,041	0,046	0,049
18	0,029	0,020	0,023	0,026	0,032	0,035	0,043	0,046	0,052	0,055
20	0,032	0,022	0,026	0,029	0,035	0,039	0,048	0,052	0,058	0,061
25	0,040	0,028	0,032	0,036	0,045	0,049	0,061	0,065	0,073	0,077

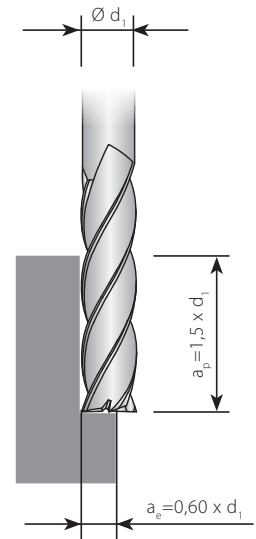

Vorschub pro Zahn bei einer radialen Zustellung 80% vom Schneidendurchmesser ($\varnothing d_1$)
 Feed per tooth with radial depth of cut of 80% of the cutter ($\varnothing d_1$)

$\varnothing d_1$ [mm]	Korrekturfaktor / Correction factor $K_f [f_z]$									
	1	0,7	0,8	0,9	1,1	1,2	1,5	1,6	1,8	1,9
1	0,001	0,001	0,001	0,001	0,001	0,001	0,001	0,001	0,001	0,001
2	0,002	0,001	0,002	0,002	0,002	0,003	0,003	0,004	0,004	0,004
3	0,004	0,002	0,003	0,003	0,004	0,004	0,006	0,006	0,007	0,007
4	0,005	0,003	0,004	0,004	0,005	0,006	0,007	0,008	0,009	0,009
5	0,006	0,004	0,005	0,005	0,007	0,007	0,009	0,010	0,011	0,012
6	0,007	0,005	0,006	0,006	0,008	0,009	0,011	0,012	0,013	0,014
8	0,010	0,007	0,008	0,009	0,011	0,012	0,015	0,016	0,018	0,019
10	0,012	0,008	0,010	0,011	0,013	0,015	0,018	0,020	0,022	0,023
12	0,015	0,010	0,012	0,013	0,016	0,018	0,022	0,024	0,027	0,028
14	0,017	0,012	0,014	0,015	0,019	0,021	0,026	0,028	0,031	0,033
16	0,020	0,014	0,016	0,018	0,022	0,024	0,030	0,032	0,036	0,038
18	0,022	0,015	0,018	0,020	0,024	0,027	0,033	0,036	0,040	0,042
20	0,025	0,017	0,020	0,022	0,027	0,030	0,037	0,040	0,045	0,047
25	0,031	0,022	0,025	0,028	0,034	0,037	0,047	0,050	0,056	0,059

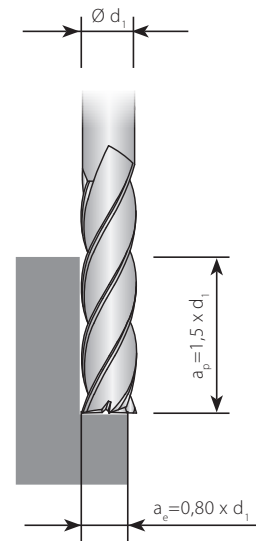

Achtung:
 Vorschub-Korrekturfaktor $\rightarrow K_f f_z = 1,10$ bei $a_p = 1 \times d_1$ und $\rightarrow K_f f_z = 1,25$ bei $a_p = 0,5 \times d_1$
 Für unbeschichtete Werkzeuge ist der Vorschub um 10-20% zu reduzieren.

Attention:
 Feed rate correction factor $\rightarrow K_f f_z = 1,10$ with $a_p = 1 \times d_1$ and $\rightarrow K_f f_z = 1,25$ with $a_p = 0,5 \times d_1$
 Feed rates are reduced by 10-20% for uncoated tools.

Vorschub pro Zahn beim Vollnutfräsen → $a_p = 0,5 \times d_1$

Feed per tooth when full slot milling → $a_p = 0,5 \times d_1$

Ø d ₁ [mm]	Korrekturfaktor / Correction factor Kf [f ₁]									
	1	0,7	0,8	0,9	1,1	1,2	1,5	1,6	1,8	1,9
1	0,002	0,001	0,001	0,001	0,002	0,002	0,003	0,003	0,003	0,003
2	0,004	0,002	0,003	0,003	0,004	0,004	0,006	0,006	0,007	0,007
3	0,007	0,004	0,005	0,006	0,007	0,008	0,010	0,011	0,012	0,013
4	0,009	0,006	0,007	0,008	0,009	0,010	0,013	0,014	0,016	0,017
5	0,011	0,007	0,008	0,009	0,012	0,013	0,016	0,017	0,019	0,020
6	0,013	0,009	0,010	0,011	0,014	0,015	0,019	0,020	0,023	0,024
8	0,018	0,012	0,014	0,016	0,019	0,021	0,027	0,028	0,032	0,034
10	0,022	0,015	0,017	0,019	0,024	0,026	0,033	0,035	0,039	0,041
12	0,030	0,021	0,024	0,027	0,033	0,036	0,045	0,048	0,054	0,057
14	0,032	0,022	0,025	0,028	0,035	0,038	0,048	0,051	0,057	0,060
16	0,036	0,025	0,028	0,032	0,039	0,043	0,054	0,057	0,064	0,068
18	0,042	0,029	0,033	0,037	0,046	0,050	0,063	0,067	0,075	0,079
20	0,045	0,031	0,036	0,040	0,049	0,054	0,067	0,072	0,081	0,085
25	0,056	0,039	0,044	0,050	0,061	0,067	0,084	0,089	0,100	0,106

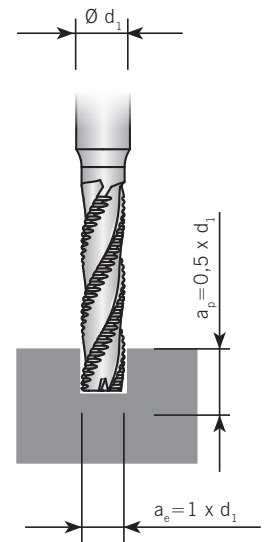

Vorschub pro Zahn beim Vollnutfräsen → $a_p = 1 \times d_1$

Feed per tooth when full slot milling → $a_p = 1 \times d_1$

Ø d ₁ [mm]	Korrekturfaktor / Correction factor Kf [f ₁]									
	1	0,7	0,8	0,9	1,1	1,2	1,5	1,6	1,8	1,9
1	0,001	0,001	0,001	0,001	0,001	0,002	0,002	0,002	0,002	0,002
2	0,003	0,002	0,002	0,002	0,003	0,003	0,004	0,004	0,005	0,005
3	0,005	0,003	0,004	0,004	0,005	0,005	0,007	0,007	0,008	0,009
4	0,006	0,004	0,005	0,005	0,006	0,007	0,009	0,009	0,011	0,011
5	0,007	0,005	0,006	0,006	0,008	0,009	0,011	0,011	0,013	0,014
6	0,008	0,006	0,007	0,008	0,009	0,010	0,013	0,014	0,015	0,016
8	0,012	0,008	0,009	0,011	0,013	0,014	0,018	0,019	0,021	0,022
10	0,014	0,010	0,011	0,013	0,016	0,017	0,021	0,023	0,026	0,027
12	0,020	0,014	0,016	0,018	0,021	0,023	0,029	0,031	0,035	0,037
14	0,021	0,015	0,017	0,019	0,023	0,025	0,031	0,033	0,037	0,040
16	0,023	0,016	0,019	0,021	0,026	0,028	0,035	0,037	0,042	0,044
18	0,027	0,019	0,022	0,025	0,030	0,033	0,041	0,044	0,049	0,052
20	0,029	0,020	0,023	0,026	0,032	0,035	0,044	0,047	0,053	0,056
25	0,036	0,025	0,029	0,033	0,040	0,044	0,055	0,058	0,066	0,069

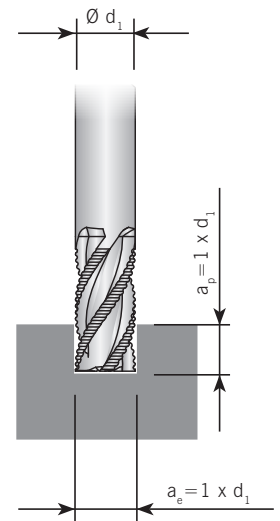

Achtung:
Für unbeschichtete Werkzeuge ist der Vorschub um 10-20% zu reduzieren.

Attention:
Feed rates are reduced by 10-20% for uncoated tools.

Alle Angaben in mm / Dimensions in mm

Vorschübe für Vollradius- und Torusfräser

Feed rates for ball nosed- and High feed cutters

d_i [mm]	fz [mm]	fz [mm]	fz [mm]	fz [mm]	fz [mm]
2	0,015	0,010	0,005	0,010	0,015
3	0,030	0,020	0,015	0,015	0,020
4	0,040	0,030	0,030	0,020	0,030
5	0,060	0,050	0,050	0,030	0,040
6	0,070	0,060	0,060	0,050	0,060
8	0,100	0,080	0,070	0,070	0,080
10	0,120	0,100	0,080	0,080	0,100
12	0,150	0,120	0,090	0,100	0,120
16	0,180	0,150	0,100	0,130	0,150
18	0,200	0,180	0,110	0,140	0,160
20	0,220	0,200	0,120	0,150	0,180
25	0,240	0,220	0,140	0,160	0,200

Achtung:
Für unbeschichtete Werkzeuge ist der Vorschub um 10-20% zu reduzieren.

Attention:
Feed rates are reduced by 10-20% for uncoated tools.

Alle Angaben in mm / Dimensions in mm

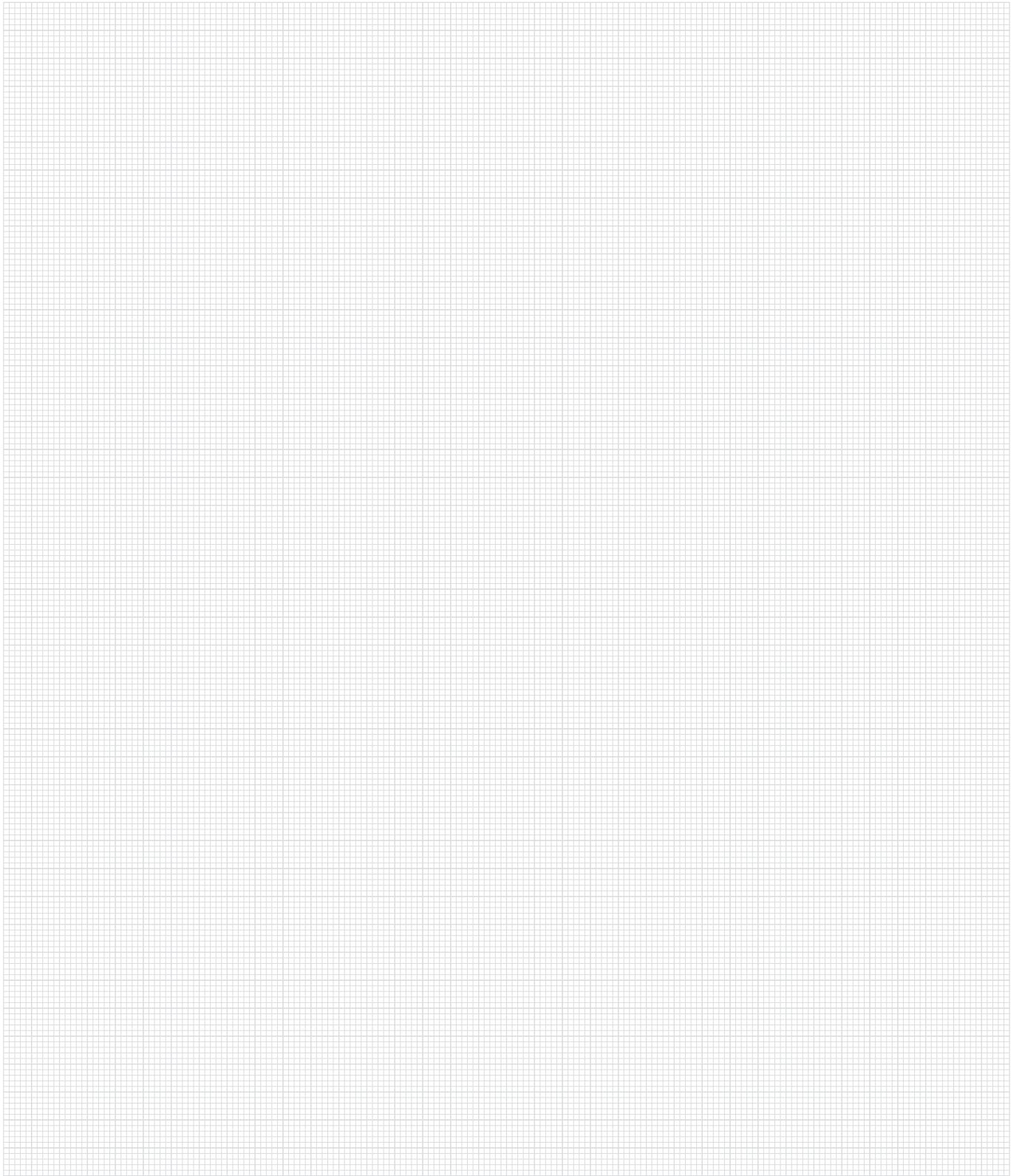

ARNO[®]
WERKZEUGE

Weitere Informationen finden Sie unter:
For more information see:

www.arno.de

ARNO[®]

WERKZEUGE

We have a passion for precision.

AUSFÜHRUNG AFX

Design AFX

Überzeugend in der Hochgeschwindigkeitsbearbeitung. Excellence in high speed machining.

NEU
NEW

Selbst bei der Hochgeschwindigkeitsbearbeitung von vorgehärteten oder naturharten Werkstoffen (bis 55 HRC) und Gusseisen erreichen die ARNO[®] AFX VHM-Fräser höchste Standzeiten. Auch für die Trockenbearbeitung geeignet.



Even at high speed machining of pre-hardened or naturally hardened materials (up-to 55HRC) the ARNO[®] AFX cutters achieve excellent tool life. Also suitable for dry machining.

VHM-Schaftfräser

2 Schneiden, Mini-Ausführung, mit Eckenradius

Solid carbide end-mill

2 flutes, mini design, with corner radius

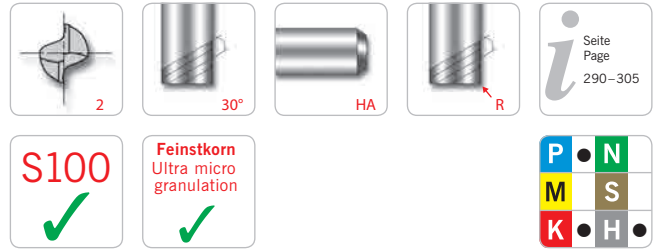

Seite
Page
290-305



AFX50124-...R...

Schaft / Shank DIN 6535HA	d	d _A	l ₁	l ₂	l	R
AFX50124-002AR0,02 N	0,2	4	0,3	1,0	40	0,02
AFX50124-002AR0,05 N	0,2	4	0,3	1,0	40	0,05
AFX50124-003AR0,02 N	0,3	4	0,5	1,0	40	0,02
AFX50124-003AR0,05 N	0,3	4	0,5	1,0	40	0,05
AFX50124-003BR0,02 N	0,3	4	0,5	2,0	40	0,02
AFX50124-003BR0,05 N	0,3	4	0,5	2,0	40	0,05
AFX50124-004AR0,05 N	0,4	4	0,6	1,0	40	0,05
AFX50124-004AR0,1 N	0,4	4	0,6	1,0	40	0,10
AFX50124-004BR0,05 N	0,4	4	0,6	1,5	40	0,05
AFX50124-004BR0,1 N	0,4	4	0,6	2,0	40	0,10
AFX50124-004CR0,05 N	0,4	4	0,6	1,0	40	0,05
AFX50124-004DR0,05 N	0,4	4	0,6	2,0	40	0,05
AFX50124-005AR0,05 N	0,5	4	0,7	1,0	45	0,05
AFX50124-005AR0,1 N	0,5	4	0,7	2,0	45	0,10
AFX50124-005BR0,05 N	0,5	4	0,7	1,5	45	0,05
AFX50124-005BR0,1 N	0,5	4	0,7	3,0	45	0,10
AFX50124-005CR0,05 N	0,5	4	0,7	2,0	45	0,05
AFX50124-005DR0,05 N	0,5	4	0,7	4,0	45	0,05
AFX50124-006AR0,05 N	0,6	4	0,9	3,0	45	0,05
AFX50124-006AR0,1 N	0,6	4	0,9	2,0	45	0,10
AFX50124-006AR0,2 N	0,6	4	0,9	2,0	45	0,20
AFX50124-006BR0,05 N	0,6	4	0,9	6,0	45	0,05
AFX50124-006BR0,1 N	0,6	4	0,9	3,0	45	0,10
AFX50124-006BR0,2 N	0,6	4	0,9	4,0	45	0,20
AFX50124-006CR0,1 N	0,6	4	0,9	4,0	45	0,10
AFX50124-006CR0,2 N	0,6	4	0,9	6,0	45	0,20
AFX50124-006DR0,1 N	0,6	4	0,9	6,0	45	0,10
AFX50124-008AR0,05 N	0,8	4	1,2	2,0	45	0,05
AFX50124-008AR0,1 N	0,8	4	1,2	2,0	45	0,10
AFX50124-008AR0,2 N	0,8	4	1,2	2,0	45	0,20
AFX50124-008BR0,05 N	0,8	4	1,2	4,0	45	0,05
AFX50124-008BR0,1 N	0,8	4	1,2	4,0	45	0,10
AFX50124-008BR0,2 N	0,8	4	1,2	4,0	45	0,20
AFX50124-008CR0,05 N	0,8	4	1,2	6,0	45	0,05
AFX50124-008CR0,1 N	0,8	4	1,2	6,0	45	0,10
AFX50124-008CR0,2 N	0,8	4	1,2	6,0	45	0,20
AFX50124-008DR0,1 N	0,8	4	1,2	8,0	45	0,10
AFX50124-008DR0,2 N	0,8	4	1,2	8,0	45	0,20
AFX50124-010AR0,05 N	1,0	4	1,5	3,0	50	0,05
AFX50124-010AR0,1 N	1,0	4	1,5	3,0	50	0,10
AFX50124-010AR0,2 N	1,0	4	1,5	3,0	50	0,20
AFX50124-010AR0,3 N	1,0	4	1,5	4,0	50	0,30
AFX50124-010BR0,05 N	1,0	4	1,5	4,0	50	0,05

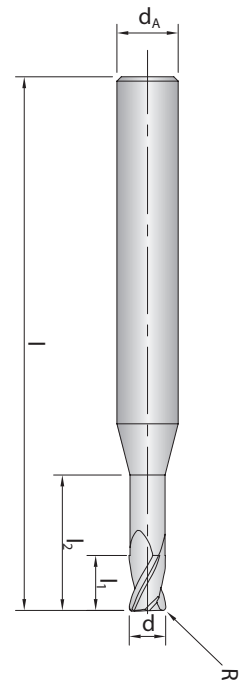

AFX

● = Hauptanwendung / Main application
○ = Nebenanwendung / Suitable

Alle Angaben in mm / Dimensions in mm

AFX50124-...R...

Schaft / Shank DIN 6535HA	d	d _A	l ₁	l ₂	l	R
AFX50124-010BR0,1	1,0	4	1,5	4,0	50	0,10
AFX50124-010BR0,2	1,0	4	1,5	4,0	50	0,20
AFX50124-010BR0,3	1,0	4	1,5	6,0	50	0,30
AFX50124-010CR0,05	1,0	4	1,5	6,0	50	0,05
AFX50124-010CR0,1	1,0	4	1,5	6,0	50	0,10
AFX50124-010CR0,2	1,0	4	1,5	6,0	50	0,20
AFX50124-010CR0,3	1,0	4	1,5	8,0	50	0,30
AFX50124-010DR0,1	1,0	4	1,5	8,0	50	0,10
AFX50124-010DR0,2	1,0	4	1,5	8,0	50	0,20
AFX50124-010DR0,3	1,0	4	1,5	10,0	50	0,30
AFX50124-010ER0,1	1,0	4	1,5	10,0	50	0,10
AFX50124-010ER0,2	1,0	4	1,5	10,0	50	0,20
AFX50124-010FR0,2	1,0	4	1,5	12,0	50	0,20
AFX50124-012AR0,05	1,2	4	1,8	6,0	50	0,05
AFX50124-012AR0,1	1,2	4	1,8	4,0	50	0,10
AFX50124-012AR0,2	1,2	4	1,8	4,0	50	0,20
AFX50124-012AR0,3	1,2	4	1,8	4,0	50	0,30
AFX50124-012BR0,05	1,2	4	1,8	8,0	50	0,05
AFX50124-012BR0,1	1,2	4	1,8	6,0	50	0,10
AFX50124-012BR0,2	1,2	4	1,8	6,0	50	0,20
AFX50124-012BR0,3	1,2	4	1,8	6,0	50	0,30
AFX50124-012CR0,05	1,2	4	1,8	10,0	50	0,05
AFX50124-012CR0,1	1,2	4	1,8	8,0	50	0,10
AFX50124-012CR0,2	1,2	4	1,8	8,0	50	0,20
AFX50124-012CR0,3	1,2	4	1,8	8,0	50	0,30
AFX50124-015AR0,05	1,5	4	2,3	4,0	50	0,05
AFX50124-015AR0,1	1,5	4	2,3	6,0	50	0,10
AFX50124-015AR0,2	1,5	4	2,3	10,0	50	0,20
AFX50124-015AR0,3	1,5	4	2,3	4,0	50	0,30
AFX50124-015AR0,5	1,5	4	2,3	6,0	50	0,50
AFX50124-015BR0,05	1,5	4	2,3	8,0	50	0,05
AFX50124-015BR0,1	1,5	4	2,3	4,0	50	0,10
AFX50124-015BR0,2	1,5	4	2,3	6,0	50	0,20
AFX50124-015BR0,3	1,5	4	2,3	8,0	50	0,30
AFX50124-015BR0,5	1,5	4	2,3	10,0	50	0,50
AFX50124-015CR0,05	1,5	4	2,3	12,0	50	0,05
AFX50124-015CR0,1	1,5	4	2,3	4,0	50	0,10
AFX50124-015CR0,2	1,5	4	2,3	8,0	50	0,20
AFX50124-015CR0,3	1,5	4	2,3	8,0	50	0,30
AFX50124-015DR0,2	1,5	4	2,3	6,0	50	0,20
AFX50124-015DR0,3	1,5	4	2,3	12,0	50	0,30
AFX50124-015ER0,2	1,5	4	2,3	6,0	50	0,20
AFX50124-015ER0,3	1,5	4	2,3	12,0	50	0,30
AFX50124-020AR0,1	2,0	4	3	6,0	50	0,10
AFX50124-020AR0,2	2,0	4	3	6,0	50	0,20
AFX50124-020AR0,3	2,0	4	3	6,0	50	0,30
AFX50124-020AR0,5	2,0	4	3	6,0	50	0,50
AFX50124-020BR0,1	2,0	4	3	8,0	50	0,10
AFX50124-020BR0,2	2,0	4	3	8,0	50	0,20
AFX50124-020BR0,3	2,0	4	3	8,0	50	0,30
AFX50124-020BR0,5	2,0	4	3	8,0	50	0,50
AFX50124-020CR0,1	2,0	4	3	10,0	50	0,10
AFX50124-020CR0,2	2,0	4	3	10,0	50	0,20
AFX50124-020CR0,3	2,0	4	3	10,0	50	0,30
AFX50124-020CR0,5	2,0	4	3	10,0	50	0,50
AFX50124-020DR0,1	2,0	4	3	12,0	50	0,10
AFX50124-020DR0,2	2,0	4	3	12,0	50	0,20
AFX50124-020DR0,3	2,0	4	3	12,0	50	0,30
AFX50124-020DR0,5	2,0	4	3	12,0	50	0,50

● = Hauptanwendung / Main application
○ = Nebenanwendung / Suitable

Alle Angaben in mm / Dimensions in mm

AFX50124-...R...

Schaft / Shank DIN 6535HA	d	d _A	l ₁	l ₂	l	R
AFX50124-020ER0,2 ●	2,0	4	3	16,0	50	0,20
AFX50124-020ER0,3 ●	2,0	4	3	16,0	50	0,30
AFX50124-020ER0,5 ●	2,0	4	3	14,0	50	0,50
AFX50124-020FR0,5 ●	2,0	4	3	16,0	50	0,50
AFX50124-030AR0,1 ●	3,0	6	4,5	10,0	50	0,10
AFX50124-030AR0,2 ●	3,0	6	4,5	8,0	50	0,20
AFX50124-030AR0,3 ●	3,0	6	4,5	8,0	60	0,30
AFX50124-030AR0,5 ●	3,0	6	4,5	8,0	50	0,50
AFX50124-030AR1,0 ●	3,0	6	4,5	8,0	50	1,00
AFX50124-030BR0,1 ●	3,0	6	4,5	12,0	50	0,10
AFX50124-030BR0,2 ●	3,0	6	4,5	10,0	50	0,20
AFX50124-030BR0,3 ●	3,0	6	4,5	10,0	50	0,30
AFX50124-030BR0,5 ●	3,0	6	4,5	10,0	50	0,50
AFX50124-030BR1,0 ●	3,0	6	4,5	10,0	50	1,00
AFX50124-030CR0,1 ●	3,0	6	4,5	16,0	60	0,10
AFX50124-030CR0,2 ●	3,0	6	4,5	12,0	50	0,20
AFX50124-030CR0,3 ●	3,0	6	4,5	12,0	50	0,30
AFX50124-030CR0,5 ●	3,0	6	4,5	12,0	50	0,50
AFX50124-030CR1,0 ●	3,0	6	4,5	12,0	50	1,00
AFX50124-030DR0,2 ●	3,0	6	4,5	16,0	60	0,20
AFX50124-030DR0,3 ●	3,0	6	4,5	16,0	60	0,30
AFX50124-030DR0,5 ●	3,0	6	4,5	16,0	60	0,50
AFX50124-030DR1,0 ●	3,0	6	4,5	16,0	60	1,00
AFX50124-030ER0,2 ●	3,0	6	4,5	20,0	60	0,20
AFX50124-030ER0,3 ●	3,0	6	4,5	20,0	60	0,30
AFX50124-030ER0,5 ●	3,0	6	4,5	20,0	60	0,50
AFX50124-030ER1,0 ●	3,0	6	4,5	20,0	60	1,00
AFX50124-030FR0,2 ●	3,0	6	4,5	26,0	65	0,20
AFX50124-030FR0,5 ●	3,0	6	4,5	26,0	65	0,50
AFX50124-040AR0,1 ●	4,0	6	6	10,0	50	0,10
AFX50124-040AR0,2 ●	4,0	6	6	10,0	50	0,20
AFX50124-040AR0,3 ●	4,0	6	6	12,0	50	0,30
AFX50124-040AR0,5 ●	4,0	6	6	10,0	50	0,50
AFX50124-040AR1,0 ●	4,0	6	6	10,0	50	1,00
AFX50124-040BR0,1 ●	4,0	6	6	12,0	50	0,10
AFX50124-040BR0,2 ●	4,0	6	6	12,0	50	0,20
AFX50124-040BR0,3 ●	4,0	6	6	16,0	60	0,30
AFX50124-040BR0,5 ●	4,0	6	6	12,0	50	0,50
AFX50124-040BR1,0 ●	4,0	6	6	12,0	50	1,00
AFX50124-040CR0,1 ●	4,0	6	6	16,0	60	0,10
AFX50124-040CR0,2 ●	4,0	6	6	16,0	60	0,20
AFX50124-040CR0,3 ●	4,0	6	6	20,0	60	0,30
AFX50124-040CR0,5 ●	4,0	6	6	16,0	60	0,50
AFX50124-040CR1,0 ●	4,0	6	6	16,0	60	1,00
AFX50124-040DR0,2 ●	4,0	6	6	20,0	60	0,20
AFX50124-040DR0,3 ●	4,0	6	6	26,0	65	0,30
AFX50124-040DR0,5 ●	4,0	6	6	20,0	60	0,50
AFX50124-040DR1,0 ●	4,0	6	6	20,0	60	1,00
AFX50124-040ER0,2 ●	4,0	6	6	26,0	65	0,20
AFX50124-040ER0,5 ●	4,0	6	6	26,0	65	0,50
AFX50124-040FR0,5 ●	4,0	6	6	30,0	70	0,50
AFX50124-060AR0,2 ●	6,0	6	9	20,0	60	0,20
AFX50124-060AR0,3 ●	6,0	6	9	20,0	60	0,30
AFX50124-060AR0,5 ●	6,0	6	9	20,0	60	0,50
AFX50124-060AR1,0 ●	6,0	6	9	20,0	60	1,00
AFX50124-060BR0,5 ●	6,0	6	15	30,0	90	0,50
AFX50124-080AR0,2 ●	8,0	8	12	25,0	70	0,20
AFX50124-080AR0,3 ●	8,0	8	12	25,0	70	0,30
AFX50124-080AR0,5 ●	8,0	8	12	25,0	70	0,50

AFX

● = Hauptanwendung / Main application
○ = Nebenanwendung / Suitable

Alle Angaben in mm / Dimensions in mm

VHM-Schaftfräser

2 Schneiden, Mini-Ausführung, mit Eckenradius

Solid carbide end-mill

2 flutes, mini design, with corner radius

AFX50124-...R...

Schaft / Shank DIN 6535HA	d	d _A	l ₁	l ₂	l	R
AFX50124-080AR1,0 ●	8,0	8	12	25,0	70	1,00
AFX50124-100AR0,3 ○	10,0	10	15	30,0	75	0,30
AFX50124-100AR0,5 ○	10,0	10	15	30,0	75	0,50
AFX50124-100AR1,0 ○	10,0	10	15	30,0	75	1,00
AFX50124-120AR0,5 ○	12,0	12	18	32,0	80	0,50
AFX50124-120AR1,0 ○	12,0	12	18	32,0	80	1,00
AFX50124-120AR1,5 ○	12,0	12	18	32,0	80	1,50
AFX50124-160AR0,5 ○	16,0	16	20	35,0	100	0,50
AFX50124-160AR1,0 ○	16,0	16	20	35,0	100	1,00
AFX50124-200AR0,5 ○	20,0	20	25	40,0	100	0,50
AFX50124-200AR1,0 ○	20,0	20	25	40,0	100	1,00

Toleranz / Tolerance (μm)	Nennwertbereich / Diameter range (mm)	
	<6	>6
Fräser / Mill	0 -0,012	0 -0,015
Radius / Radius	0 ±0,010	0 ±0,015
Schaft / Shank	h6	

● = Hauptanwendung / Main application
○ = Nebenanwendung / Suitable

Alle Angaben in mm / Dimensions in mm

VHM-Schaftfräser

2 Schneiden, kurze Ausführung

Solid carbide end-mill

2 flutes, short design



N NEU/NEW

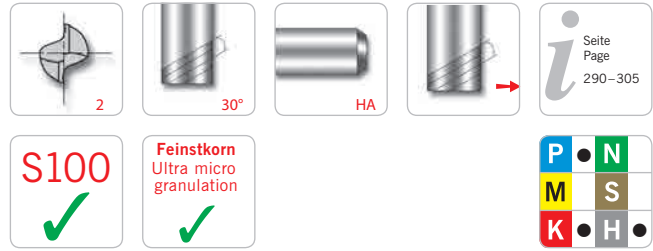

AFX50120-...

Schaft / Shank DIN 6535HA	d	d _A	l ₁	l
AFX50120-001 N	0,1	4	0,2	40
AFX50120-002 N	0,2	4	0,4	40
AFX50120-003 N	0,3	4	0,6	40
AFX50120-004 N	0,4	4	0,8	40
AFX50120-005 N	0,5	4	1	40
AFX50120-006 N	0,6	4	1,2	40
AFX50120-007 N	0,7	4	1,4	40
AFX50120-008 N	0,8	4	1,6	40
AFX50120-009 N	0,9	4	1,8	40
AFX50120-010 N	1,0	6	2,5	50
AFX50120-012 N	1,2	6	3	50
AFX50120-015 N	1,5	6	4	50
AFX50120-020 N	2,0	6	6	50
AFX50120-025 N	2,5	6	7	50
AFX50120-030 N	3,0	6	8	50
AFX50120-035 N	3,5	6	10	50
AFX50120-040 N	4,0	6	10	50
AFX50120-045 N	4,5	6	14	50
AFX50120-050 N	5,0	6	15	60
AFX50120-055 N	5,5	6	15	60
AFX50120-060 N	6,0	6	15	60
AFX50120-065 N	6,5	8	18	60
AFX50120-070 N	7,0	8	20	60
AFX50120-075 N	7,5	8	20	60
AFX50120-080 N	8,0	8	20	70
AFX50120-085 N	8,5	10	22	70
AFX50120-090 N	9,0	10	22	70
AFX50120-095 N	9,5	10	24	70
AFX50120-100 N	10,0	10	25	75
AFX50120-105 N	10,5	12	26	75
AFX50120-110 N	11,0	12	30	75
AFX50120-115 N	11,5	12	30	80
AFX50120-120 N	12,0	12	30	80
AFX50120-130 N	13,0	12	35	100
AFX50120-140 N	14,0	16	35	100
AFX50120-150 N	15,0	16	38	100
AFX50120-160 N	16,0	16	40	100
AFX50120-180 N	18,0	16	45	100
AFX50120-200 N	20,0	20	45	100

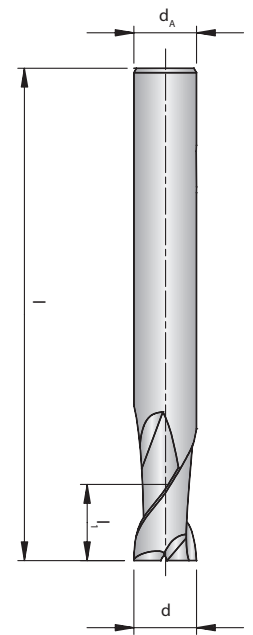

Toleranz / Tolerance	Nennwert- bereich / Diameter range (mm)	
(µm)	<6	>6
Fräser / Mill	0 -0,012	0 -0,015
Schaft / Shank	h6	h6

AFX

VHM-Schaftfräser

2 Schneiden, lange Ausführung



Solid carbide end-mill

2 flutes, long design

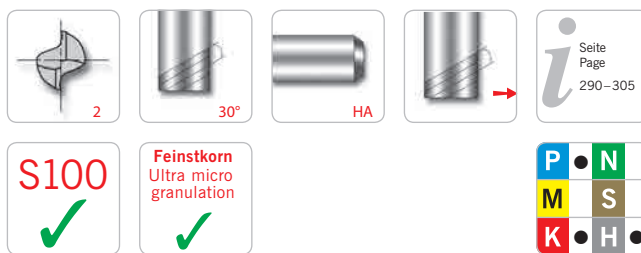

AFX50121-...

Schaft / Shank DIN 6535HA	d	d _A	l ₁	l
AFX50121-010A	1,0	6	3	60
AFX50121-010B	1,0	6	4	60
AFX50121-010C	1,0	6	6	60
AFX50121-010D	1,0	6	8	60
AFX50121-010E	1,0	6	10	60
AFX50121-015A	1,5	6	6	60
AFX50121-015B	1,5	6	8	60
AFX50121-015C	1,5	6	10	60
AFX50121-015D	1,5	6	12	60
AFX50121-015E	1,5	6	16	60
AFX50121-020A	2,0	6	8	60
AFX50121-020B	2,0	6	10	60
AFX50121-020C	2,0	6	12	60
AFX50121-020D	2,0	6	16	60
AFX50121-025A	2,5	6	10	60
AFX50121-025B	2,5	6	16	60
AFX50121-030A	3,0	6	10	70
AFX50121-030B	3,0	6	12	70
AFX50121-030C	3,0	6	16	70
AFX50121-030D	3,0	6	20	70
AFX50121-030E	3,0	6	26	70
AFX50121-040A	4,0	6	12	70
AFX50121-040B	4,0	6	16	70
AFX50121-040C	4,0	6	20	70
AFX50121-040D	4,0	6	26	70
AFX50121-040E	4,0	6	30	70
AFX50121-050A	5,0	6	20	70
AFX50121-050B	5,0	6	25	70
AFX50121-050C	5,0	6	30	80
AFX50121-050D	5,0	6	40	100
AFX50121-060A	6,0	6	15	60
AFX50121-060B	6,0	6	15	80
AFX50121-060C	6,0	6	20	70
AFX50121-060D	6,0	6	20	90
AFX50121-060E	6,0	6	25	75
AFX50121-060F	6,0	6	30	80
AFX50121-060G	6,0	6	30	100
AFX50121-060H	6,0	6	30	150
AFX50121-060I	6,0	6	35	90
AFX50121-060J	6,0	6	40	90
AFX50121-060K	6,0	6	45	150
AFX50121-080A	8,0	8	25	80
AFX50121-080B	8,0	8	30	80

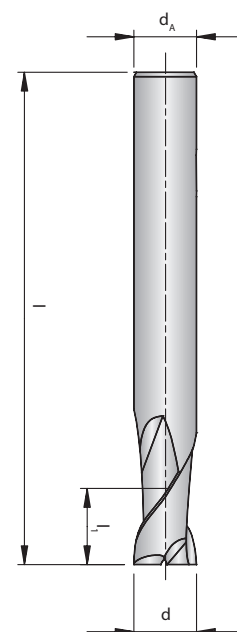

AFX

● = Hauptanwendung / Main application
○ = Nebenanwendung / Suitable

Alle Angaben in mm / Dimensions in mm

AFX50121-...

Schaft / Shank DIN 6535HA	d	d _A	l ₁	l
AFX50121-080C N	8,0	8	35	90
AFX50121-080D N	8,0	8	40	90
AFX50121-080E N	8,0	8	40	120
AFX50121-080F N	8,0	8	45	100
AFX50121-080G N	8,0	8	50	100
AFX50121-100A N	10,0	10	30	80
AFX50121-100B N	10,0	10	30	100
AFX50121-100C N	10,0	10	35	90
AFX50121-100D N	10,0	10	40	90
AFX50121-100E N	10,0	10	40	120
AFX50121-100F N	10,0	10	45	100
AFX50121-100G N	10,0	10	50	100
AFX50121-100H N	10,0	10	50	150
AFX50121-100I N	10,0	10	60	110
AFX50121-120A N	12,0	12	35	90
AFX50121-120B N	12,0	12	40	100
AFX50121-120C N	12,0	12	40	120
AFX50121-120D N	12,0	12	45	130
AFX50121-120E N	12,0	12	50	100
AFX50121-120F N	12,0	12	55	110
AFX50121-120G N	12,0	12	60	110
AFX50121-120H N	12,0	12	60	150
AFX50121-140 N	14,0	16	50	110
AFX50121-160A N	16,0	16	40	150
AFX50121-160B N	16,0	16	50	110
AFX50121-180 N	18,0	20	50	120
AFX50121-200A N	20,0	20	90	200
AFX50121-200B N	20,0	20	110	200

Toleranz / Tolerance	
Fräser / Mill	0 -0,03
Schaft / Shank	h6

AFX

● = Hauptanwendung / Main application
○ = Nebenanwendung / Suitable

Alle Angaben in mm / Dimensions in mm

VHM-Schaftfräser

2 Schneiden, lange Ausführung mit Eckenradius

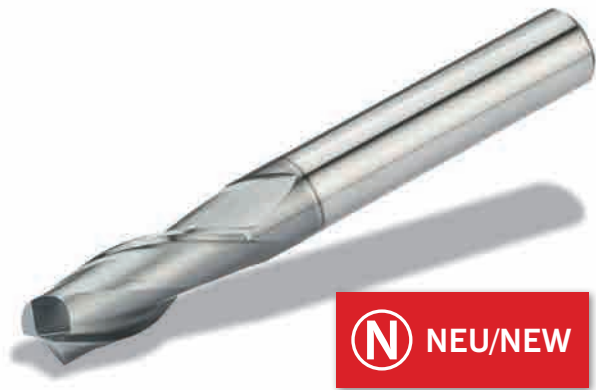

Solid carbide end-mill

2 flutes, long design with corner radius

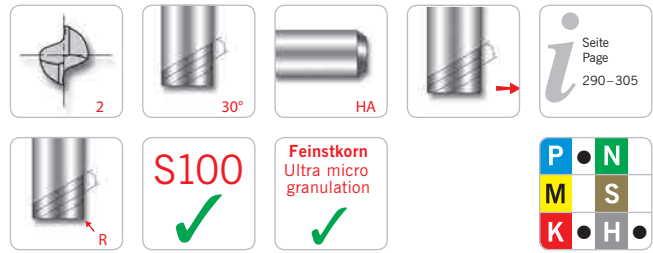

AFX50121-...R...

Schaft / Shank DIN 6535HA	d	d _A	l ₁	l	R
AFX50121-010AR0,1 N	1,0	6	2,5	50	0,10
AFX50121-010AR0,2 N	1,0	6	2,5	50	0,20
AFX50121-010AR0,3 N	1,0	6	2,5	50	0,30
AFX50121-015AR0,2 N	1,5	6	4	50	0,20
AFX50121-015AR0,3 N	1,5	6	4	50	0,30
AFX50121-015AR0,5 N	1,5	6	4	50	0,50
AFX50121-020AR0,1 N	2,0	6	6	50	0,10
AFX50121-020AR0,2 N	2,0	6	6	50	0,20
AFX50121-020AR0,3 N	2,0	6	6	50	0,30
AFX50121-020AR0,5 N	2,0	6	6	50	0,50
AFX50121-030AR0,1 N	3,0	6	8	60	0,10
AFX50121-030AR0,2 N	3,0	6	8	60	0,20
AFX50121-030AR0,3 N	3,0	6	8	60	0,30
AFX50121-030AR0,5 N	3,0	6	8	60	0,50
AFX50121-040AR0,2 N	4,0	6	10	70	0,20
AFX50121-040AR0,3 N	4,0	6	10	70	0,30
AFX50121-040AR0,5 N	4,0	6	10	70	0,50
AFX50121-040AR1,0 N	4,0	6	10	70	1,00
AFX50121-050AR0,2 N	5,0	6	13	90	0,20
AFX50121-050AR0,3 N	5,0	6	13	90	0,30
AFX50121-050AR0,5 N	5,0	6	13	90	0,50
AFX50121-050AR1,0 N	5,0	6	13	90	1,00
AFX50121-060AR0,2 N	6,0	6	15	60	0,20
AFX50121-060AR0,3 N	6,0	6	15	60	0,30
AFX50121-060AR0,5 N	6,0	6	15	60	0,50
AFX50121-060AR1,0 N	6,0	6	15	60	1,00
AFX50121-060BR0,2 N	6,0	6	15	90	0,20
AFX50121-060BR0,3 N	6,0	6	15	90	0,30
AFX50121-060BR0,5 N	6,0	6	15	90	0,50
AFX50121-060BR1,0 N	6,0	6	15	90	1,00
AFX50121-060CR1,0 N	6,0	6	15	110	1,00
AFX50121-060DR1,0 N	6,0	6	15	130	1,00
AFX50121-080AR0,2 N	8,0	8	20	100	0,20
AFX50121-080AR0,3 N	8,0	8	20	70	0,30
AFX50121-080AR0,5 N	8,0	8	20	70	0,50
AFX50121-080AR1,0 N	8,0	8	20	70	1,00
AFX50121-080AR2,0 N	8,0	8	20	100	2,00
AFX50121-080BR0,5 N	8,0	8	20	100	0,50
AFX50121-080BR1,0 N	8,0	8	20	100	1,00
AFX50121-080BR1,5 N	8,0	8	20	100	1,50
AFX50121-100AR0,2 N	10,0	10	25	100	0,20
AFX50121-100AR0,5 N	10,0	10	25	75	0,50
AFX50121-100AR1,0 N	10,0	10	25	75	1,00

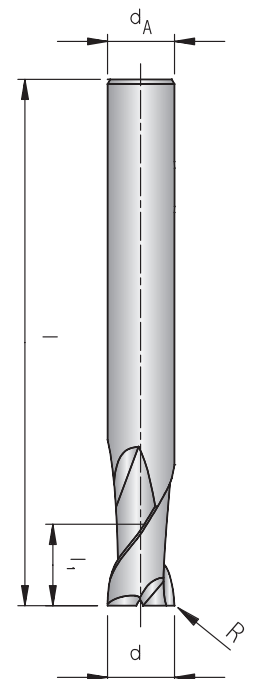

AFX

● = Hauptanwendung / Main application
○ = Nebenanwendung / Suitable

Alle Angaben in mm / Dimensions in mm

VHM-Schafffräser

2 Schneiden, lange Ausführung mit Eckenradius

Solid carbide end-mill

2 flutes, long design with corner radius

AFX50121-...R...

Schaft / Shank DIN 6535HA	d	d _A	l ₁	l	R
AFX50121-100AR1,5 ●	10,0	10	25	100	1,50
AFX50121-100AR2,0 ●	10,0	10	25	100	2,00
AFX50121-100BR0,5 ●	10,0	10	25	100	0,50
AFX50121-100BR1,0 ●	10,0	10	25	100	1,00
AFX50121-120AR0,3 ●	12,0	12	30	110	0,30
AFX50121-120AR0,5 ●	12,0	12	30	80	0,50
AFX50121-120AR1,0 ●	12,0	12	30	80	1,00
AFX50121-120AR1,5 ●	12,0	12	30	110	1,50
AFX50121-120AR2,0 ●	12,0	12	30	110	2,00
AFX50121-120AR2,5 ●	12,0	12	30	110	2,50
AFX50121-120AR3,0 ●	12,0	12	30	110	3,00
AFX50121-120BR0,5 ●	12,0	12	30	110	0,50
AFX50121-120BR1,0 ●	12,0	12	30	110	1,00
AFX50121-120CR1,0 ●	12,0	12	30	130	1,00
AFX50121-160AR1,0 ●	16,0	16	35	150	1,00
AFX50121-160AR2,0 ●	16,0	16	32	150	2,00
AFX50121-160BR1,0 ●	16,0	16	32	150	1,00
AFX50121-200AR1,0 ●	20,0	20	38	150	1,00
AFX50121-200AR2,0 ●	20,0	20	38	150	2,00

Toleranz / Tolerance (μm)	Nennwertbereich / Diameter range (mm)	
	<6	>6
Fräser / Mill	0 -0,012	0 -0,015
Radius / Radius	0 ±0,010	0 ±0,015
Schaft / Shank	h6	h6

AFX

● = Hauptanwendung / Main application
○ = Nebenanwendung / Suitable

VHM-Schaftfräser

2 Schneiden, extra lange Ausführung



N NEU/NEW

Solid carbide end-mill

2 flutes, extra long design

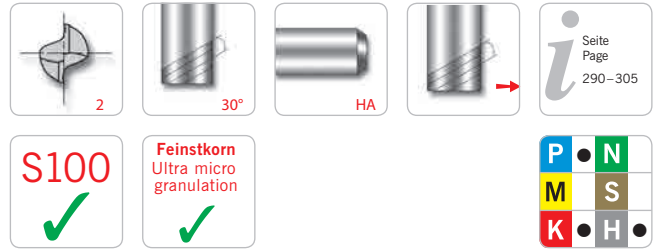

AFX50122-...

Schaft / Shank DIN 6535HA	d	d _A	l ₁	l ₂	l
AFX50122-002A N	0,2	4	0,3	1,0	40
AFX50122-003A N	0,3	4	0,5	1,5	40
AFX50122-003B N	0,3	4	0,5	2,0	40
AFX50122-004A N	0,4	4	0,6	1,0	40
AFX50122-004B N	0,4	4	0,6	1,5	40
AFX50122-004C N	0,4	4	0,6	2,0	40
AFX50122-004D N	0,4	4	0,6	3,0	40
AFX50122-004E N	0,4	4	0,6	4,0	40
AFX50122-004F N	0,4	4	0,6	5,0	40
AFX50122-005A N	0,5	4	0,7	2,0	45
AFX50122-005B N	0,5	4	0,7	3,0	45
AFX50122-005C N	0,5	4	0,7	4,0	45
AFX50122-005D N	0,5	4	0,7	5,0	45
AFX50122-005E N	0,5	4	0,7	6,0	45
AFX50122-006A N	0,6	4	0,9	2,0	45
AFX50122-006B N	0,6	4	0,9	3,0	45
AFX50122-006C N	0,6	4	0,9	4,0	45
AFX50122-006D N	0,6	4	0,9	5,0	45
AFX50122-006E N	0,6	4	0,9	6,0	45
AFX50122-006F N	0,6	4	0,9	8,0	45
AFX50122-006G N	0,6	4	0,9	10,0	45
AFX50122-008A N	0,8	4	1,2	2,0	45
AFX50122-008B N	0,8	4	1,2	3,0	45
AFX50122-008C N	0,8	4	1,2	4,0	45
AFX50122-008D N	0,8	4	1,2	5,0	45
AFX50122-008E N	0,8	4	1,2	6,0	45
AFX50122-008F N	0,8	4	1,2	8,0	45
AFX50122-008G N	0,8	4	1,2	10,0	45
AFX50122-010A N	1,0	4	1,5	3,0	50
AFX50122-010B N	1,0	4	1,5	4,0	50
AFX50122-010C N	1,0	4	1,5	5,0	50
AFX50122-010D N	1,0	4	1,5	6,0	50
AFX50122-010E N	1,0	4	1,5	8,0	50
AFX50122-010F N	1,0	4	1,5	10,0	50
AFX50122-010G N	1,0	4	1,5	12,0	50
AFX50122-010H N	1,0	4	1,5	14,0	50
AFX50122-010I N	1,0	4	1,5	16,0	50
AFX50122-010J N	1,0	4	1,5	20,0	50
AFX50122-012A N	1,2	4	1,8	6,0	50
AFX50122-012B N	1,2	4	1,8	8,0	50
AFX50122-012C N	1,2	4	1,8	10,0	50
AFX50122-014A N	1,4	4	2,1	6,0	50
AFX50122-014B N	1,4	4	2,1	8,0	50

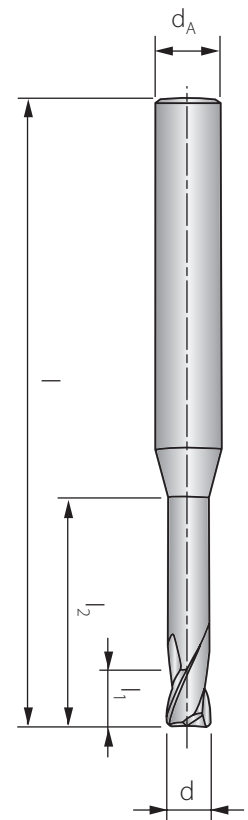

AFX

● = Hauptanwendung / Main application
○ = Nebenanwendung / Suitable

Alle Angaben in mm / Dimensions in mm

AFX50122-...

Schaft / Shank DIN 6535HA	d	d _A	l ₁	l ₂	l
AFX50122-015A ●	1,5	4	2,3	4,0	50
AFX50122-015B ●	1,5	4	2,3	6,0	50
AFX50122-015C ●	1,5	4	2,3	8,0	50
AFX50122-015D ●	1,5	4	2,3	10,0	50
AFX50122-015E ●	1,5	4	2,3	12,0	50
AFX50122-015F ●	1,5	4	2,3	14,0	50
AFX50122-015G ●	1,5	4	2,3	16,0	50
AFX50122-015H ●	1,5	4	2,3	20,0	50
AFX50122-018A ●	1,8	4	2,7	8,0	50
AFX50122-018B ●	1,8	4	2,7	10,0	50
AFX50122-018C ●	1,8	4	2,7	12,0	50
AFX50122-020A ●	2,0	4	3	6,0	50
AFX50122-020B ●	2,0	4	3	8,0	50
AFX50122-020C ●	2,0	4	3	10,0	50
AFX50122-020D ●	2,0	4	3	12,0	50
AFX50122-020E ●	2,0	4	3	14,0	50
AFX50122-020F ●	2,0	4	3	16,0	50
AFX50122-020G ●	2,0	4	3	20,0	50
AFX50122-025A ●	2,5	4	4	8,0	50
AFX50122-025B ●	2,5	4	4	12,0	50
AFX50122-025C ●	2,5	4	4	16,0	50
AFX50122-025D ●	2,5	4	4	20,0	50
AFX50122-030A ●	3,0	6	4,5	8,0	50
AFX50122-030B ●	3,0	6	4,5	10,0	50
AFX50122-030C ●	3,0	6	4,5	12,0	50
AFX50122-030D ●	3,0	6	4,5	14,0	60
AFX50122-030E ●	3,0	6	4,5	16,0	60
AFX50122-030F ●	3,0	6	4,5	18,0	60
AFX50122-030G ●	3,0	6	4,5	20,0	60
AFX50122-030H ●	3,0	6	4,5	26,0	65
AFX50122-040A ●	4,0	6	6	10,0	50
AFX50122-040B ●	4,0	6	6	12,0	50
AFX50122-040C ●	4,0	6	6	16,0	60
AFX50122-040D ●	4,0	6	6	18,0	60
AFX50122-040E ●	4,0	6	6	20,0	60
AFX50122-040F ●	4,0	6	6	26,0	65
AFX50122-040G ●	4,0	6	6	30,0	70
AFX50122-050A ●	5,0	6	8	20,0	60
AFX50122-050B ●	5,0	6	8	30,0	70
AFX50122-050C ●	5,0	6	8	35,0	75
AFX50122-050D ●	5,0	6	8	40,0	80
AFX50122-050E ●	5,0	6	8	50,0	90
AFX50122-060A ●	6,0	6	9	15,0	60
AFX50122-060B ●	6,0	6	9	20,0	60
AFX50122-060C ●	6,0	6	9	30,0	70
AFX50122-080A ●	8,0	8	12	25,0	70
AFX50122-100A ●	10,0	10	15	30,0	75
AFX50122-100B ●	10,0	10	15	45,0	100
AFX50122-120A ●	12,0	12	20	35,0	80
AFX50122-120B ●	12,0	12	20	50,0	110

AFX

Toleranz / Tolerance (µm)	Nennwertbereich / Diameter range (mm)	
	<6	>6
Fräser / Mill	0 -0,012	0 -0,015
Schaft / Shank	h6	h6

● = Hauptanwendung / Main application
○ = Nebenanwendung / Suitable

Alle Angaben in mm / Dimensions in mm

VHM-Radiusfräser

2 Schneiden, lange Ausführung



N NEU/NEW

Solid carbide ball-nose end-mill

2 flutes, long design

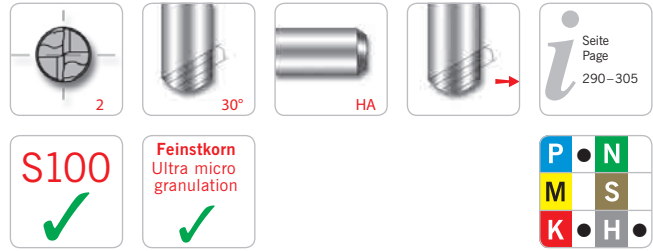

AFX50321-...

Schaft / Shank DIN 6535HA	d	d _A	l ₁	l	R
AFX50321-001A N	0,1	4	0,2	40	0,05
AFX50321-002A N	0,2	4	0,4	40	0,10
AFX50321-003A N	0,3	4	0,6	40	0,15
AFX50321-004A N	0,4	4	0,8	40	0,20
AFX50321-005A N	0,5	4	1	40	0,25
AFX50321-006A N	0,6	4	1,2	40	0,30
AFX50321-007A N	0,7	4	1,4	40	0,35
AFX50321-008A N	0,8	4	1,6	40	0,40
AFX50321-009A N	0,9	4	1,8	40	0,45
AFX50321-010A N	1,0	4	2,5	50	0,50
AFX50321-010B N	1,0	6	2,5	50	0,50
AFX50321-010C N	1,0	6	2,5	70	0,50
AFX50321-012A N	1,2	6	3	50	0,60
AFX50321-015A N	1,5	4	4	50	0,75
AFX50321-015B N	1,5	6	4	50	0,75
AFX50321-015C N	1,5	6	4	70	0,75
AFX50321-020A N	2,0	4	5	50	1,00
AFX50321-020B N	2,0	6	3	40	1,00
AFX50321-020C N	2,0	6	5	50	1,00
AFX50321-020D N	2,0	6	5	80	1,00
AFX50321-025A N	2,5	6	6	60	1,25
AFX50321-025B N	2,5	6	6	80	1,25
AFX50321-030A N	3,0	4	6	60	1,50
AFX50321-030B N	3,0	6	4,5	40	1,50
AFX50321-030C N	3,0	6	6	60	1,50
AFX50321-030D N	3,0	6	6	80	1,50
AFX50321-030E N	3,0	6	6	100	1,50
AFX50321-040A N	4,0	4	8	70	2,00
AFX50321-040B N	4,0	4	8	100	2,00
AFX50321-040C N	4,0	6	6	50	2,00
AFX50321-040D N	4,0	6	8	70	2,00
AFX50321-040E N	4,0	6	8	100	2,00
AFX50321-040F N	4,0	6	8	120	2,00
AFX50321-045 N	4,5	6	9	80	2,25
AFX50321-050A N	5,0	6	7,5	60	2,50
AFX50321-050B N	5,0	6	10	80	2,50
AFX50321-060 N	6,0	6	9	50	3,00
AFX50321-060A N	6,0	6	9	60	3,00
AFX50321-060B N	6,0	6	9	80	3,00
AFX50321-060C N	6,0	6	12	90	3,00
AFX50321-060D N	6,0	6	12	130	3,00
AFX50321-060E N	6,0	6	12	150	3,00
AFX50321-070A N	7,0	8	14	90	3,50

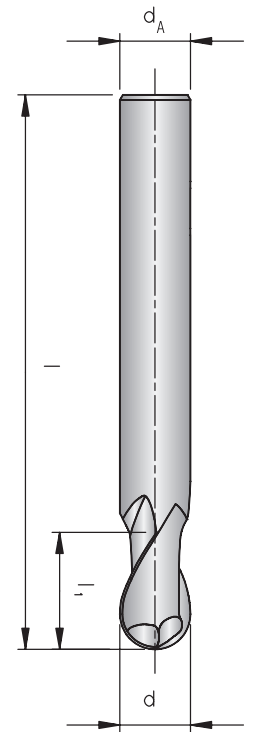

AFX

● = Hauptanwendung / Main application
○ = Nebenanwendung / Suitable

Alle Angaben in mm / Dimensions in mm

AFX50321-...

Schaft / Shank DIN 6535HA	d	d _A	l ₁	l	R
AFX50321-080A ●	8,0	8	12	50	4,00
AFX50321-080B ●	8,0	8	12	60	4,00
AFX50321-080C ●	8,0	8	12	80	4,00
AFX50321-080D ●	8,0	8	12	90	4,00
AFX50321-080E ●	8,0	8	14	100	4,00
AFX50321-080F ●	8,0	8	14	150	4,00
AFX50321-090 ●	9,0	10	18	100	4,50
AFX50321-100A ●	10,0	10	15	60	5,00
AFX50321-100B ●	10,0	10	15	90	5,00
AFX50321-100C ●	10,0	10	18	100	5,00
AFX50321-100D ●	10,0	10	18	130	5,00
AFX50321-100E ●	10,0	10	18	150	5,00
AFX50321-100F ●	10,0	10	18	180	5,00
AFX50321-110 ●	11,0	12	20	100	5,50
AFX50321-120A ●	12,0	12	18	80	6,00
AFX50321-120B ●	12,0	12	18	100	6,00
AFX50321-120C ●	12,0	12	22	110	6,00
AFX50321-120D ●	12,0	12	22	130	6,00
AFX50321-120E ●	12,0	12	22	150	6,00
AFX50321-120F ●	12,0	12	22	200	6,00
AFX50321-130A ●	13,0	12	24	100	6,50
AFX50321-140A ●	14,0	14	26	100	7,00
AFX50321-160A ●	16,0	16	24	100	8,00
AFX50321-160B ●	16,0	16	30	150	8,00
AFX50321-200A ●	20,0	20	30	100	10,00
AFX50321-200B ●	20,0	20	38	150	10,00

Toleranz / Tolerance (µm)	Nennwertbereich / Diameter range (mm)	
	<6	>6
Fräser / Mill	0 -0,012	0 -0,015
Radius / Radius	0 ±0,005	0 ±0,010
Schaft / Shank	h6	

VHM-Radiusfräser

2 Schneiden, lange Ausführung (Schlitzfräsen)

Solid carbide ball-nose end-mill

2 flutes, long design (Slotting)



N NEU/NEW

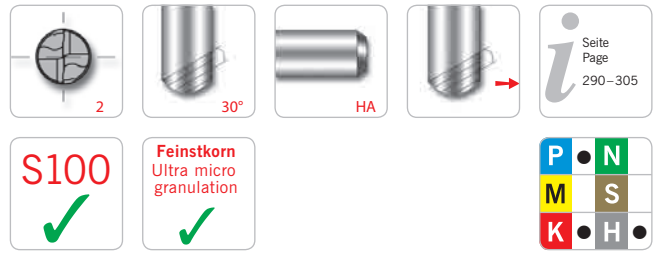

AFX52021-...

Schaft / Shank DIN 6535HA	d	d _A	l ₁	l ₂	l	R
AFX52021-002A N	0,2	4	0,2	0,5	40	0,10
AFX52021-002B N	0,2	4	0,2	1,0	40	0,10
AFX52021-002C N	0,2	4	0,2	1,5	40	0,10
AFX52021-002D N	0,2	4	0,2	3,0	40	0,10
AFX52021-003A N	0,3	4	0,3	1,0	40	0,15
AFX52021-003B N	0,3	4	0,3	1,5	40	0,15
AFX52021-003C N	0,3	4	0,3	2,0	40	0,15
AFX52021-003D N	0,3	4	0,3	3,0	40	0,15
AFX52021-004A N	0,4	4	0,4	1,0	40	0,20
AFX52021-004B N	0,4	4	0,4	1,5	40	0,20
AFX52021-004C N	0,4	4	0,4	2,0	40	0,20
AFX52021-004D N	0,4	4	0,4	3,0	40	0,20
AFX52021-004E N	0,4	4	0,4	4,0	40	0,20
AFX52021-004F N	0,4	4	0,4	5,0	40	0,20
AFX52021-004G N	0,4	4	0,4	6,0	40	0,20
AFX52021-005A N	0,5	4	0,5	1,0	45	0,25
AFX52021-005B N	0,5	4	0,5	2,0	45	0,25
AFX52021-005C N	0,5	4	0,5	3,0	45	0,25
AFX52021-005D N	0,5	4	0,5	4,0	45	0,25
AFX52021-005E N	0,5	4	0,5	5,0	45	0,25
AFX52021-005F N	0,5	4	0,5	6,0	45	0,25
AFX52021-005G N	0,5	4	0,5	8,0	45	0,25
AFX52021-005H N	0,5	4	0,5	10,0	45	0,25
AFX52021-006A N	0,6	4	0,6	1,0	45	0,30
AFX52021-006B N	0,6	4	0,6	2,0	45	0,30
AFX52021-006C N	0,6	4	0,6	3,0	45	0,30
AFX52021-006D N	0,6	4	0,6	4,0	45	0,30
AFX52021-006E N	0,6	4	0,6	5,0	45	0,30
AFX52021-006F N	0,6	4	0,6	6,0	45	0,30
AFX52021-006G N	0,6	4	0,6	8,0	45	0,30
AFX52021-006H N	0,6	4	0,6	10,0	45	0,30
AFX52021-006I N	0,6	4	0,6	12,0	45	0,30
AFX52021-007A N	0,7	4	0,7	6,0	45	0,35
AFX52021-008A N	0,8	4	0,8	2,0	45	0,40
AFX52021-008B N	0,8	4	0,8	3,0	45	0,40
AFX52021-008C N	0,8	4	0,8	4,0	45	0,40
AFX52021-008D N	0,8	4	0,8	5,0	45	0,40
AFX52021-008E N	0,8	4	0,8	6,0	45	0,40
AFX52021-008F N	0,8	4	0,8	8,0	45	0,40
AFX52021-008G N	0,8	4	0,8	10,0	45	0,40
AFX52021-010A N	1,0	6	1	5,0	50	0,50
AFX52021-010B N	1,0	6	1	6,0	50	0,50
AFX52021-010C N	1,0	6	1	8,0	50	0,50

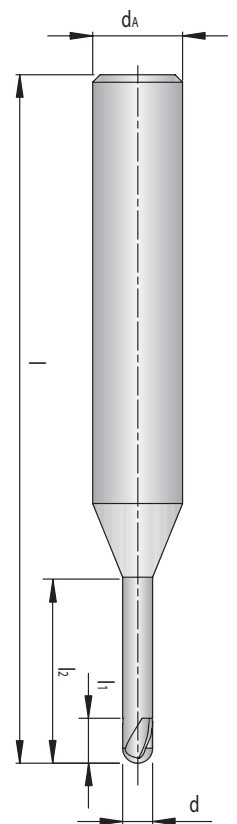

AFX

● = Hauptanwendung / Main application
○ = Nebenanwendung / Suitable

Alle Angaben in mm / Dimensions in mm

AFX52021-...

Schaft / Shank DIN 6535HA	d	d _A	l ₁	l ₂	l	R
AFX52021-020A ●	2,0	6	2	8,0	50	1,00
AFX52021-020B ○	2,0	6	2	10,0	50	1,00
AFX52021-030A ●	3,0	6	3	8,0	50	1,50
AFX52021-030B ○	3,0	6	3	10,0	50	1,50
AFX52021-030C ●	3,0	6	3	12,0	50	1,50
AFX52021-030D ○	3,0	6	3	14,0	60	1,50
AFX52021-030E ●	3,0	6	3	16,0	60	1,50
AFX52021-030F ○	3,0	6	3	18,0	60	1,50
AFX52021-030G ●	3,0	6	3	20,0	60	1,50
AFX52021-030H ○	3,0	6	3	26,0	65	1,50
AFX52021-030I ●	3,0	6	3	30,0	70	1,50
AFX52021-030J ○	3,0	6	3	35,0	70	1,50
AFX52021-040A ●	4,0	6	4	10,0	50	2,00
AFX52021-040B ○	4,0	6	4	12,0	50	2,00
AFX52021-040C ●	4,0	6	4	14,0	60	2,00
AFX52021-040D ○	4,0	6	4	16,0	60	2,00
AFX52021-040E ●	4,0	6	4	18,0	60	2,00
AFX52021-040F ○	4,0	6	4	20,0	60	2,00
AFX52021-040G ●	4,0	6	4	26,0	65	2,00
AFX52021-040H ○	4,0	6	4	30,0	70	2,00
AFX52021-040I ●	4,0	6	4	35,0	70	2,00
AFX52021-040J ○	4,0	6	4	40,0	80	2,00
AFX52021-050A ●	5,0	6	6	30,0	70	2,50
AFX52021-060A ○	6,0	6	8	20,0	60	3,00
AFX52021-060B ●	6,0	6	8	30,0	60	3,00
AFX52021-080A ○	8,0	8	10	25,0	70	4,00
AFX52021-080B ●	8,0	8	14	35,0	100	4,00
AFX52021-100A ○	10,0	10	12	30,0	75	5,00
AFX52021-100B ●	10,0	10	18	30,0	100	5,00
AFX52021-100C ○	10,0	10	18	40,0	100	5,00
AFX52021-120A ●	12,0	12	14	32,0	80	6,00
AFX52021-120B ○	12,0	12	22	32,0	110	6,00

AFX

Toleranz / Tolerance (μm)	Nennwertbereich / Diameter range (mm)	
	<6	>6
Fräser / Mill	0 -0,012	0 -0,015
Radius / Radius	0 ±0,005	0 ±0,010
Schaft / Shank	h6	h6

● = Hauptanwendung / Main application
○ = Nebenanwendung / Suitable

Alle Angaben in mm / Dimensions in mm

VHM-Schaftfräser

4 Schneiden, kurze Ausführung



N NEU/NEW

Solid carbide end-mill

4 flutes, short design

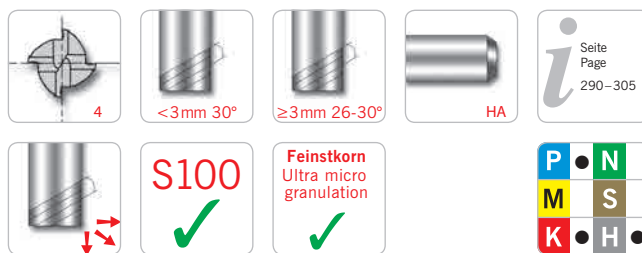

Seite
Page
290-305

AFX50140-...

Schaft / Shank DIN 6535HA	d	d _A	l ₁	l
AFX50140-010 N	1,0	6	2,5	50
AFX50140-015 N	1,5	6	4	50
AFX50140-020 N	2,0	6	6	50
AFX50140-025 N	2,5	6	7	50
AFX50140-030 N	3,0	6	8	50
AFX50140-035 N	3,5	6	10	50
AFX50140-040 N	4,0	6	10	50
AFX50140-045 N	4,5	6	14	50
AFX50140-050 N	5,0	6	15	60
AFX50140-055 N	5,5	6	15	60
AFX50140-060 N	6,0	6	15	60
AFX50140-065 N	6,5	8	18	60
AFX50140-070 N	7,0	8	20	60
AFX50140-075 N	7,5	8	20	60
AFX50140-080 N	8,0	8	20	70
AFX50140-085 N	8,5	10	22	70
AFX50140-090 N	9,0	10	22	70
AFX50140-095 N	9,5	10	24	70
AFX50140-100 N	10,0	10	25	75
AFX50140-105 N	10,5	12	26	75
AFX50140-110 N	11,0	12	30	75
AFX50140-115 N	11,5	12	30	80
AFX50140-120 N	12,0	12	30	80
AFX50140-130 N	13,0	12	35	100
AFX50140-140 N	14,0	14	35	100
AFX50140-160 N	16,0	16	40	100
AFX50140-180 N	18,0	18	45	100
AFX50140-200 N	20,0	20	45	100
AFX50140-250 N	25,0	25	50	120

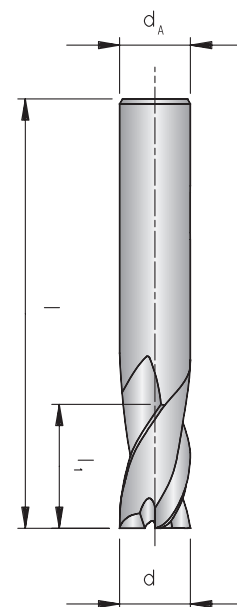

AFX

Toleranz / Tolerance

Fräser / Mill	0 -0,03
Schaft / Shank	h6

● = Hauptanwendung / Main application
○ = Nebenanwendung / Suitable

Alle Angaben in mm / Dimensions in mm

VHM-Schaftfräser

4 Schneiden, lange Ausführung, mit Eckenradius

Solid carbide end-mill

4 flutes, long design, with corner radius

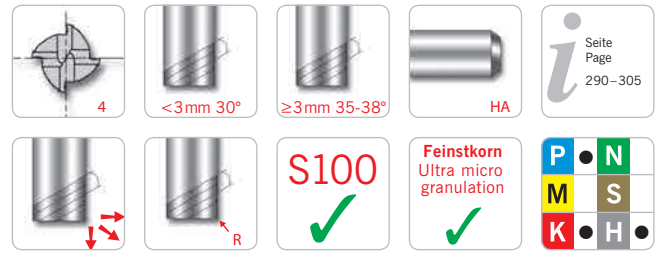

AFX50041-...R...

Schaft / Shank DIN 6535HA	d	d _A	l ₁	l ₂	l	R
AFX50041-010AR0,1	1,0	4	1,5	4,0	50	0,10
AFX50041-010AR0,2	1,0	4	1,5	4,0	50	0,20
AFX50041-010AR0,3	1,0	4	1,5	4,0	50	0,30
AFX50041-010BR0,1	1,0	4	1,5	6,0	50	0,10
AFX50041-010BR0,2	1,0	4	1,5	6,0	50	0,20
AFX50041-010BR0,3	1,0	4	1,5	6,0	50	0,30
AFX50041-010CR0,1	1,0	4	1,5	8,0	50	0,10
AFX50041-010CR0,2	1,0	4	1,5	8,0	50	0,20
AFX50041-010CR0,3	1,0	4	1,5	8,0	50	0,30
AFX50041-012AR0,1	1,2	4	1,8	4,0	50	0,10
AFX50041-012AR0,2	1,2	4	1,8	4,0	50	0,20
AFX50041-012AR0,3	1,2	4	1,8	4,0	50	0,30
AFX50041-012BR0,1	1,2	4	1,8	6,0	50	0,10
AFX50041-012BR0,2	1,2	4	1,8	6,0	50	0,20
AFX50041-012BR0,3	1,2	4	1,8	6,0	50	0,30
AFX50041-012CR0,1	1,2	4	1,8	8,0	50	0,10
AFX50041-012CR0,2	1,2	4	1,8	8,0	50	0,20
AFX50041-012CR0,3	1,2	4	1,8	8,0	50	0,30
AFX50041-015AR0,1	1,5	4	2,3	6,0	50	0,10
AFX50041-015AR0,2	1,5	4	2,3	6,0	50	0,20
AFX50041-015AR0,3	1,5	4	2,3	6,0	50	0,30
AFX50041-015AR0,5	1,5	4	2,3	6,0	50	0,50
AFX50041-015BR0,1	1,5	4	2,3	8,0	50	0,10
AFX50041-015BR0,2	1,5	4	2,3	8,0	50	0,20
AFX50041-015BR0,3	1,5	4	2,3	8,0	50	0,30
AFX50041-015BR0,5	1,5	4	2,3	8,0	50	0,50
AFX50041-015CR0,1	1,5	4	2,3	10,0	50	0,10
AFX50041-015CR0,2	1,5	4	2,3	10,0	50	0,20
AFX50041-015CR0,3	1,5	4	2,3	10,0	50	0,30
AFX50041-015CR0,5	1,5	4	2,3	10,0	50	0,50
AFX50041-015DR0,1	1,5	4	2,3	12,0	50	0,10
AFX50041-015DR0,2	1,5	4	2,3	12,0	50	0,20
AFX50041-015DR0,3	1,5	4	2,3	12,0	50	0,30
AFX50041-015DR0,5	1,5	4	2,3	12,0	50	0,50
AFX50041-020AR0,1	2,0	4	3	6,0	50	0,10
AFX50041-020AR0,2	2,0	4	3	6,0	50	0,20
AFX50041-020AR0,3	2,0	4	3	6,0	50	0,30
AFX50041-020AR0,5	2,0	4	3	6,0	50	0,50
AFX50041-020BR0,1	2,0	4	3	8,0	50	0,10
AFX50041-020BR0,2	2,0	4	3	8,0	50	0,20
AFX50041-020BR0,3	2,0	4	3	8,0	50	0,30
AFX50041-020BR0,5	2,0	4	3	8,0	50	0,50
AFX50041-020CR0,1	2,0	4	3	10,0	50	0,10

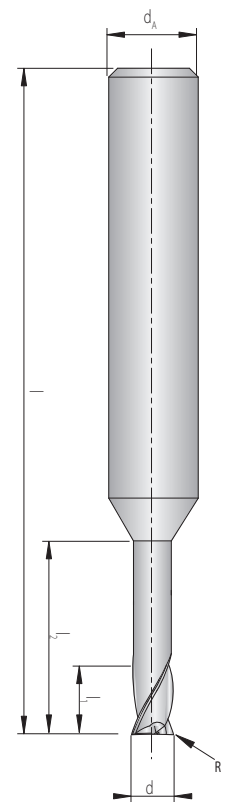

AFX

● = Hauptanwendung / Main application
○ = Nebenanwendung / Suitable

Alle Angaben in mm / Dimensions in mm

VHM-Schafffräser

4 Schneiden, lange Ausführung, mit Eckenradius

Solid carbide end-mill

4 flutes, long design, with corner radius

AFX50041-...R...

Schaft / Shank DIN 6535HA	d	d _A	l ₁	l ₂	l	R
AFX50041-020CR0,2 N	2,0	4	3	10,0	50	0,20
AFX50041-020CR0,3 N	2,0	4	3	10,0	50	0,30
AFX50041-020CR0,5 N	2,0	4	3	10,0	50	0,50
AFX50041-020DR0,1 N	2,0	4	3	12,0	50	0,10
AFX50041-020DR0,2 N	2,0	4	3	12,0	50	0,20
AFX50041-020DR0,3 N	2,0	4	3	12,0	50	0,30
AFX50041-020DR0,5 N	2,0	4	3	12,0	50	0,50
AFX50041-030AR0,1 N	3,0	6	4,5	8,0	50	0,10
AFX50041-030AR0,2 N	3,0	6	4,5	10,0	50	0,20
AFX50041-030AR0,3 N	3,0	6	4,5	8,0	50	0,30
AFX50041-030AR0,5 N	3,0	6	4,5	8,0	60	0,50
AFX50041-030AR1,0 N	3,0	6	4,5	8,0	50	1,00
AFX50041-030BR0,1 N	3,0	6	4,5	10,0	50	0,10
AFX50041-030BR0,2 N	3,0	6	4,5	12,0	60	0,20
AFX50041-030BR0,3 N	3,0	6	4,5	10,0	60	0,30
AFX50041-030BR0,5 N	3,0	6	4,5	10,0	50	0,50
AFX50041-030BR1,0 N	3,0	6	4,5	10,0	50	1,00
AFX50041-030CR0,1 N	3,0	6	4,5	12,0	50	0,10
AFX50041-030CR0,2 N	3,0	6	4,5	16,0	60	0,20
AFX50041-030CR0,3 N	3,0	6	4,5	12,0	50	0,30
AFX50041-030CR0,5 N	3,0	6	4,5	12,0	50	0,50
AFX50041-030CR1,0 N	3,0	6	4,5	12,0	50	1,00
AFX50041-030DR0,1 N	3,0	6	4,5	16,0	60	0,10
AFX50041-030DR0,2 N	3,0	6	4,5	20,0	60	0,20
AFX50041-030DR0,3 N	3,0	6	4,5	16,0	60	0,30
AFX50041-030DR0,5 N	3,0	6	4,5	16,0	60	0,50
AFX50041-030DR1,0 N	3,0	6	4,5	16,0	60	1,00
AFX50041-030ER0,3 N	3,0	6	4,5	20,0	60	0,30
AFX50041-030ER0,5 N	3,0	6	4,5	20,0	60	0,50
AFX50041-030FR0,5 N	3,0	6	4,5	26,0	65	0,50
AFX50041-040AR0,1 N	4,0	6	6	10,0	50	0,10
AFX50041-040AR0,2 N	4,0	6	6	10,0	50	0,20
AFX50041-040AR0,3 N	4,0	6	6	10,0	50	0,30
AFX50041-040AR0,5 N	4,0	6	6	10,0	50	0,50
AFX50041-040AR1,0 N	4,0	6	6	10,0	50	1,00
AFX50041-040BR0,1 N	4,0	6	6	12,0	50	0,10
AFX50041-040BR0,2 N	4,0	6	6	12,0	50	0,20
AFX50041-040BR0,3 N	4,0	6	6	12,0	50	0,30
AFX50041-040BR0,5 N	4,0	6	6	12,0	50	0,50
AFX50041-040BR1,0 N	4,0	6	6	12,0	50	1,00
AFX50041-040CR0,1 N	4,0	6	6	16,0	60	0,10
AFX50041-040CR0,2 N	4,0	6	6	16,0	60	0,20
AFX50041-040CR0,3 N	4,0	6	6	16,0	60	0,30
AFX50041-040CR0,5 N	4,0	6	6	16,0	60	0,50
AFX50041-040CR1,0 N	4,0	6	6	16,0	60	1,00
AFX50041-040DR0,1 N	4,0	6	6	20,0	60	0,10
AFX50041-040DR0,2 N	4,0	6	6	20,0	60	0,20
AFX50041-040DR0,3 N	4,0	6	6	20,0	60	0,30
AFX50041-040DR0,5 N	4,0	6	6	20,0	60	0,50
AFX50041-040DR1,0 N	4,0	6	6	20,0	60	1,00
AFX50041-040ER0,2 N	4,0	6	6	26,0	65	0,20
AFX50041-040ER0,3 N	4,0	6	6	26,0	65	0,30
AFX50041-040ER0,5 N	4,0	6	6	26,0	65	0,50
AFX50041-040ER1,0 N	4,0	6	6	26,0	65	1,00
AFX50041-060AR0,3 N	6,0	6	9	20,0	60	0,30
AFX50041-060AR0,5 N	6,0	6	9	20,0	60	0,50
AFX50041-060AR1,0 N	6,0	6	9	20,0	60	1,00
AFX50041-080AR0,2 N	8,0	8	12	25,0	70	0,20
AFX50041-080AR0,3 N	8,0	8	12	25,0	70	0,30

● = Hauptanwendung / Main application
○ = Nebenanwendung / Suitable

Alle Angaben in mm / Dimensions in mm

















VHM-Schafffräser

4 Schneiden, lange Ausführung, mit Eckenradius

Solid carbide end-mill

4 flutes, long design, with corner radius

AFX50041-...R...

Schaft / Shank DIN 6535HA	d	d _A	l ₁	l ₂	l	R
AFX50041-080AR0,5 	8,0	8	12	25,0	70	0,50
AFX50041-080AR1,0 	8,0	8	12	25,0	70	1,00
AFX50041-080BR0,5 	8,0	8	20	35,0	100	0,50
AFX50041-100AR0,3 	10,0	10	15	30,0	75	0,30
AFX50041-100AR0,5 	10,0	10	15	30,0	75	0,50
AFX50041-100AR1,0 	10,0	10	15	30,0	75	1,00
AFX50041-100AR1,5 	10,0	10	15	30,0	75	1,50
AFX50041-100BR0,5 	10,0	10	25	40,0	100	0,50
AFX50041-120AR0,5 	12,0	12	18	32,0	80	0,50
AFX50041-120AR1,0 	12,0	12	18	32,0	80	1,00
AFX50041-120AR1,5 	12,0	12	18	32,0	80	1,50
AFX50041-120AR2,0 	12,0	12	18	32,0	80	2,00
AFX50041-120BR0,5 	12,0	12	30	45,0	110	0,50
AFX50041-160AR0,5 	16,0	16	20	35,0	100	0,50
AFX50041-160AR1,0 	16,0	16	20	35,0	100	1,00
AFX50041-200AR0,5 	20,0	20	25	40,0	100	0,50
AFX50041-200AR1,0 	20,0	20	25	40,0	100	1,00

Toleranz / Tolerance

Fräser / Mill	0 -0,03
Radius / Radius	± 0,02
Schaft / Shank	h6

VHM-Schaftfräser

4 Schneiden, lange Ausführung, mit Eckenradius



N NEU/NEW

Solid carbide end-mill

4 flutes, long design, with corner radius

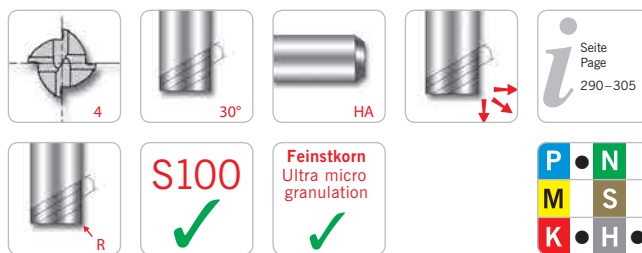

AFX50741-...R...

Schaft / Shank DIN 6535HA	d	d _A	l ₁	l	R
AFX50741-010R0,1 N	1,0	6	2,5	50	0,10
AFX50741-015R0,2 N	1,5	6	4	50	0,20
AFX50741-020R0,1 N	2,0	6	6	50	0,10
AFX50741-020R0,2 N	2,0	6	6	50	0,20
AFX50741-025R0,2 N	2,5	6	7	60	0,20
AFX50741-030R0,2 N	3,0	6	8	60	0,20
AFX50741-030R0,3 N	3,0	6	8	60	0,30
AFX50741-030R0,5 N	3,0	6	8	60	0,50
AFX50741-040R0,2 N	4,0	6	10	70	0,20
AFX50741-040R0,3 N	4,0	6	10	70	0,30
AFX50741-040R0,5 N	4,0	6	10	70	0,50
AFX50741-040R1,0 N	4,0	6	10	70	1,00
AFX50741-050R0,3 N	5,0	6	13	90	0,30
AFX50741-050R0,5 N	5,0	6	13	90	0,50
AFX50741-060AR0,2 N	6,0	6	15	60	0,20
AFX50741-060BR0,2 N	6,0	6	15	90	0,20
AFX50741-060R0,3 N	6,0	6	15	90	0,30
AFX50741-060R0,5 N	6,0	6	15	90	0,50
AFX50741-060R1,0 N	6,0	6	15	90	1,00
AFX50741-080AR0,3 N	8,0	8	20	70	0,30
AFX50741-080AR0,5 N	8,0	8	20	70	0,50
AFX50741-080AR1,0 N	8,0	8	20	70	1,00
AFX50741-080BR0,3 N	8,0	8	20	100	0,30
AFX50741-080BR0,5 N	8,0	8	20	100	0,50
AFX50741-080BR1,0 N	8,0	8	20	100	1,00
AFX50741-080R0,2 N	8,0	8	20	100	0,20
AFX50741-080R1,5 N	8,0	8	20	100	1,50
AFX50741-080R2,0 N	8,0	8	20	100	2,00
AFX50741-100AR0,5 N	10,0	10	25	75	0,50
AFX50741-100BR0,5 N	10,0	10	25	100	0,50
AFX50741-100R0,3 N	10,0	10	25	100	0,30
AFX50741-100R1,0 N	10,0	10	25	100	1,00
AFX50741-100R1,5 N	10,0	10	25	100	1,50
AFX50741-100R2,0 N	10,0	10	25	100	2,00
AFX50741-120AR0,5 N	12,0	12	30	80	0,50
AFX50741-120AR1,0 N	12,0	12	30	80	1,00
AFX50741-120BR0,5 N	12,0	12	30	110	0,50
AFX50741-120R1,0 N	12,0	12	30	110	1,00
AFX50741-120R1,5 N	12,0	12	30	110	1,50
AFX50741-120R2,0 N	12,0	12	30	110	2,00
AFX50741-160R0,5 N	16,0	16	32	150	0,50
AFX50741-160R1,0 N	16,0	16	32	150	1,00
AFX50741-160R1,5 N	16,0	16	32	150	1,50

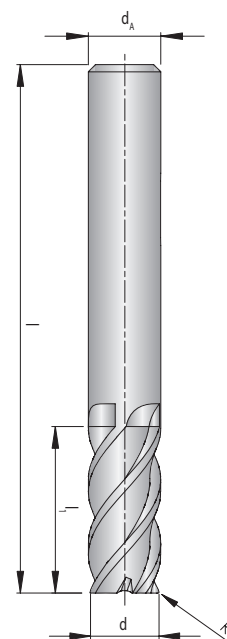

AFX

● = Hauptanwendung / Main application
○ = Nebenanwendung / Suitable

Alle Angaben in mm / Dimensions in mm

VHM-Schaftfräser

4 Schneiden, lange Ausführung, mit Eckenradius

Solid carbide end-mill

4 flutes, long design, with corner radius

AFX50741-...R...

Schaft / Shank DIN 6535HA	d	d _A	l ₁	l	R
AFX50741-160R2,0 N	16,0	16	32	150	2,00
AFX50741-200R1,0 N	20,0	20	38	150	1,00
AFX50741-200R2,0 N	20,0	20	38	150	2,00

Toleranz / Tolerance	
Fräser / Mill	0 -0,03
Radius / Radius	± 0,02
Schaft / Shank	h6

VHM-Schaftfräser

4 Schneiden, extra lange Ausführung



N NEU/NEW

Solid carbide end-mill

4 flutes, extra long design

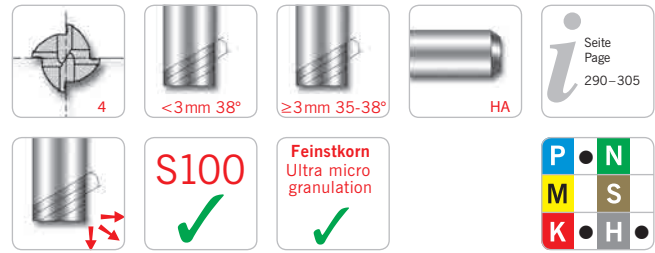

AFX50042-...

Schaft / Shank DIN 6535HA	d	d _A	l ₁	l
AFX50042-010A N	1,0	6	2,5	50
AFX50042-012A N	1,2	6	3	50
AFX50042-015A N	1,5	6	4	50
AFX50042-020A N	2,0	6	6	50
AFX50042-025A N	2,5	6	7	50
AFX50042-030A N	3,0	6	8	50
AFX50042-040A N	4,0	6	10	50
AFX50042-050A N	5,0	6	15	60
AFX50042-060A N	6,0	6	15	60
AFX50042-060B N	6,0	6	25	60
AFX50042-080A N	8,0	8	20	70
AFX50042-100A N	10,0	10	25	75
AFX50042-120A N	12,0	12	30	80
AFX50042-120B N	12,0	12	35	80
AFX50042-160A N	16,0	16	32	100
AFX50042-200A N	20,0	20	45	100

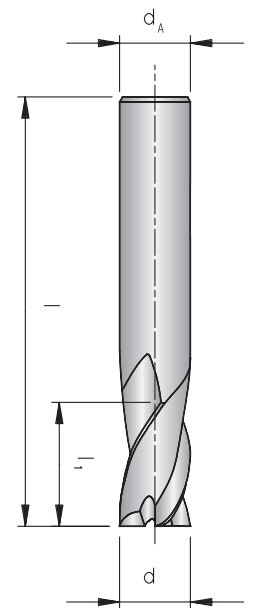

AFX

Toleranz / Tolerance	
Fräser / Mill	0 -0,03
Schaft / Shank	h6

● = Hauptanwendung / Main application
○ = Nebenanwendung / Suitable

Alle Angaben in mm / Dimensions in mm

VHM-Schaftfräser

4 Schneiden, lange Ausführung

Solid carbide end-mill

4 flutes, long design



N NEU/NEW

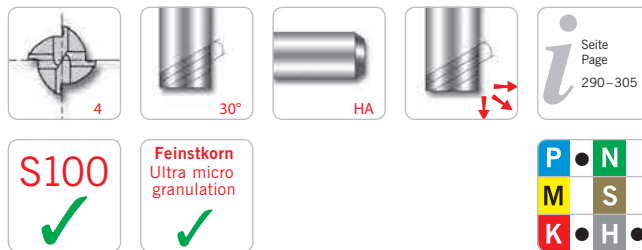

AFX50141-...

Schaft / Shank DIN 6535HA	d	d _A	l ₁	l
AFX50141-010A N	1,0	6	3	60
AFX50141-010B N	1,0	6	4	60
AFX50141-010C N	1,0	6	5	60
AFX50141-010D N	1,0	6	6	60
AFX50141-015A N	1,5	6	6	60
AFX50141-020A N	2,0	6	8	60
AFX50141-020B N	2,0	6	10	60
AFX50141-020C N	2,0	6	12	60
AFX50141-020D N	2,0	6	14	60
AFX50141-025A N	2,5	6	10	60
AFX50141-025B N	2,5	6	12	60
AFX50141-030A N	3,0	6	10	70
AFX50141-030B N	3,0	6	12	70
AFX50141-030C N	3,0	6	16	70
AFX50141-030D N	3,0	6	20	70
AFX50141-030E N	3,0	6	26	70
AFX50141-030F N	3,0	6	30	70
AFX50141-040A N	4,0	6	12	70
AFX50141-040B N	4,0	6	16	70
AFX50141-040C N	4,0	6	20	70
AFX50141-040D N	4,0	6	26	70
AFX50141-040E N	4,0	6	30	70
AFX50141-050A N	5,0	6	20	70
AFX50141-050B N	5,0	6	25	70
AFX50141-050C N	5,0	6	30	80
AFX50141-060A N	6,0	6	15	60
AFX50141-060B N	6,0	6	20	70
AFX50141-060C N	6,0	6	20	90
AFX50141-060D N	6,0	6	25	75
AFX50141-060E N	6,0	6	30	80
AFX50141-060F N	6,0	6	30	100
AFX50141-060G N	6,0	6	35	90
AFX50141-060H N	6,0	6	40	90
AFX50141-060I N	6,0	6	40	120
AFX50141-060J N	6,0	6	45	150
AFX50141-080A N	8,0	8	30	80
AFX50141-080B N	8,0	8	35	90
AFX50141-080C N	8,0	8	40	90
AFX50141-080D N	8,0	8	45	100
AFX50141-080E N	8,0	8	25	80
AFX50141-080F N	8,0	8	50	100
AFX50141-080G N	8,0	8	50	150
AFX50141-100A N	10,0	10	30	80

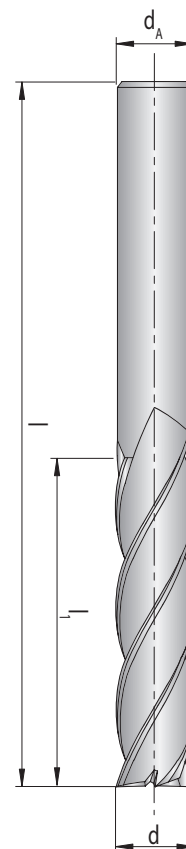

AFX





















VHM-Schafffräser

4 Schneiden, lange Ausführung

Solid carbide end-mill

4 flutes, long design

AFX50141-...

Schaft / Shank DIN 6535HA	d	d _A	l ₁	l
AFX50141-100B 	10,0	10	30	100
AFX50141-100C 	10,0	10	35	90
AFX50141-100D 	10,0	10	40	90
AFX50141-100E 	10,0	10	45	100
AFX50141-100F 	10,0	10	50	100
AFX50141-120A 	12,0	12	35	90
AFX50141-120B 	12,0	12	40	100
AFX50141-120C 	12,0	12	45	130
AFX50141-120D 	12,0	12	50	100
AFX50141-120E 	12,0	12	55	110
AFX50141-120F 	12,0	12	60	110
AFX50141-120G 	12,0	12	60	150
AFX50141-160A 	14,0	16	50	110
AFX50141-160B 	16,0	16	50	110
AFX50141-160C 	16,0	16	60	120
AFX50141-160D 	16,0	16	70	130
AFX50141-160E 	16,0	16	70	150
AFX50141-180A 	18,0	20	50	120
AFX50141-200A 	20,0	20	60	130
AFX50141-200B 	20,0	20	90	200
AFX50141-250A 	25,0	25	90	150

Toleranz / Tolerance

Fräser / Mill	0 -0,03
Schaft / Shank	h6

● = Hauptanwendung / Main application
○ = Nebenanwendung / Suitable

Alle Angaben in mm / Dimensions in mm

VHM-Schaftfräser

4 Schneiden, extra lange Ausführung

Solid carbide end-mill

4 flutes, extra long design



N NEU/NEW

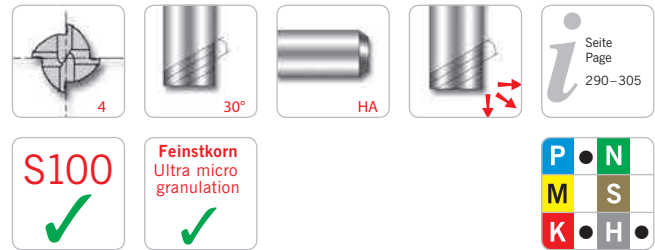

AFX50142-...

Schaft / Shank DIN 6535HA	d	d _A	l ₁	l ₂	l
AFX50142-010A N	1,0	4	1,5	4,0	50
AFX50142-010B N	1,0	4	1,5	5,0	50
AFX50142-010C N	1,0	4	1,5	6,0	50
AFX50142-010D N	1,0	4	1,5	8,0	50
AFX50142-015A N	1,5	4	2,3	6,0	50
AFX50142-015B N	1,5	4	2,3	8,0	50
AFX50142-015C N	1,5	4	2,3	10,0	50
AFX50142-015D N	1,5	4	2,3	12,0	50
AFX50142-015E N	1,5	4	2,3	16,0	50
AFX50142-020A N	2,0	4	3	8,0	50
AFX50142-020B N	2,0	4	3	10,0	50
AFX50142-020C N	2,0	4	3	12,0	50
AFX50142-020D N	2,0	4	3	16,0	50
AFX50142-030A N	3,0	6	4,5	10,0	50
AFX50142-030B N	3,0	6	4,5	12,0	50
AFX50142-030C N	3,0	6	4,5	16,0	60
AFX50142-030D N	3,0	6	4,5	20,0	60
AFX50142-030E N	3,0	6	4,5	30,0	70
AFX50142-040A N	4,0	6	6	12,0	50
AFX50142-040B N	4,0	6	6	16,0	60
AFX50142-040C N	4,0	6	6	20,0	60
AFX50142-040D N	4,0	6	6	30,0	70
AFX50142-040E N	4,0	6	6	40,0	80
AFX50142-050A N	5,0	6	8	20,0	60
AFX50142-050B N	5,0	6	8	40,0	80
AFX50142-060A N	6,0	6	9	15,0	60
AFX50142-060B N	6,0	6	9	30,0	70
AFX50142-080A N	8,0	8	12	25,0	70
AFX50142-080B N	8,0	8	12	42,0	100
AFX50142-100A N	10,0	10	15	30,0	75
AFX50142-100B N	10,0	10	15	45,0	100
AFX50142-120A N	12,0	12	20	35,0	80
AFX50142-120B N	12,0	12	20	50,0	110

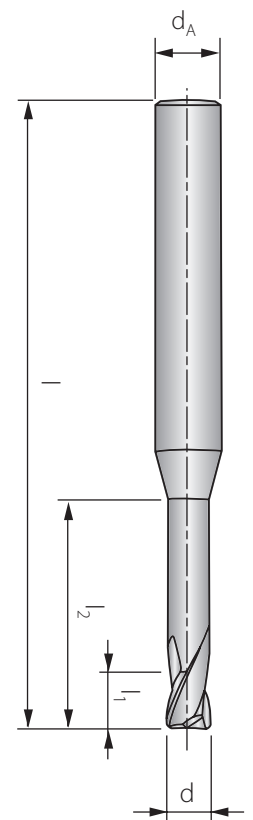

Toleranz / Tolerance	
Fräser / Mill	0 -0,03
Schaft / Shank	h6

AFX

● = Hauptanwendung / Main application
○ = Nebenanwendung / Suitable

Alle Angaben in mm / Dimensions in mm

VHM-Schaftfräser

6 Schneiden, kurze Ausführung



N NEU/NEW

Solid carbide end-mill

6 flutes, short design

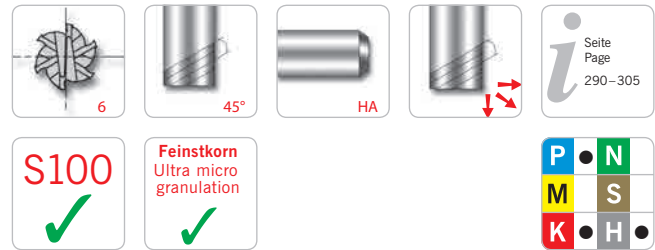

AFX50260-...

Schaft / Shank DIN 6535HA	d	d _A	l ₁	l
AFX50260-060A N	6,0	6	15	60
AFX50260-060B N	6,0	6	30	80
AFX50260-080A N	8,0	8	20	70
AFX50260-080B N	8,0	8	40	90
AFX50260-100A N	10,0	10	25	75
AFX50260-100B N	10,0	10	40	90
AFX50260-120A N	12,0	12	30	80
AFX50260-120B N	12,0	12	50	100
AFX50260-120C N	12,0	12	60	110
AFX50260-160A N	16,0	16	40	100
AFX50260-160B N	16,0	16	60	120
AFX50260-200A N	20,0	20	45	100
AFX50260-200B N	20,0	20	60	120

Toleranz / Tolerance	
Fräser / Mill	0 -0,03
Schaft / Shank	h6

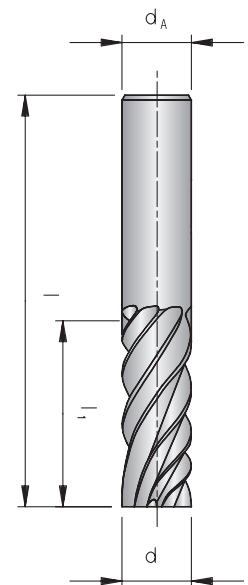

AFX

● = Hauptanwendung / Main application
○ = Nebenanwendung / Suitable

Alle Angaben in mm / Dimensions in mm

MATERIAL		Unlegierter Stahl / Non-alloyed steel Legierter Stahl / Alloy steel Gusseisen / Cast iron					Legierter Stahl / Alloy steel Hochwarmfester Stahl / Heat resistant steel					Gehärteter Stahl / Hardened steel				
Härte / Hardness Zugfestigkeit / Strength		~ HRC 35 ~ 1100 N/mm ²					HRC 35 ~ HRC 45 1110 ~ 1500 N/mm ²					HRC 45 ~ HRC 55 1500 ~ 2000 N/mm ²				
d	l ₂	a _p	n	f _z	v _f	v _c	a _p	n	f _z	v _f	v _c	a _p	n	f _z	v _f	v _c
(mm)	(mm)	(mm)	(U/min)	(mm)	(mm/min)	(m/min)	(mm)	(U/min)	(mm)	(mm/min)	(m/min)	(mm)	(U/min)	(mm)	(mm/min)	(m/min)
0,2	1,0	0,028	50.000	0,002	170	31	0,021	34.500	0,001	75	22	0,017	21.150	0,001	45	13
0,3	1,0	0,042	50.000	0,002	200	47	0,032	32.000	0,001	85	30	0,025	20.000	0,001	50	19
0,3	2,0	0,024	45.000	0,002	160	42	0,018	28.800	0,001	70	27	0,014	18.000	0,001	40	17
0,4	1,0	0,080	50.000	0,002	200	63	0,060	32.000	0,001	85	40	0,048	20.000	0,001	50	25
0,4	1,5	0,056	50.000	0,002	200	63	0,042	32.000	0,001	85	40	0,034	20.000	0,001	50	25
0,4	2,0	0,056	50.000	0,002	200	63	0,042	32.000	0,001	85	40	0,034	20.000	0,001	50	25
0,4	2,5	0,032	45.000	0,002	160	57	0,024	28.800	0,001	70	36	0,019	18.000	0,001	40	23
0,5	1,0	0,100	43.000	0,003	220	68	0,075	28.000	0,002	95	44	0,060	17.100	0,002	60	27
0,5	1,5	0,100	43.000	0,003	220	68	0,075	28.000	0,002	95	44	0,060	17.100	0,002	60	27
0,5	2,0	0,070	43.000	0,003	220	68	0,053	28.000	0,002	95	44	0,042	17.100	0,002	60	27
0,5	3,0	0,040	38.700	0,002	180	61	0,030	25.200	0,001	75	40	0,024	15.390	0,002	50	24
0,5	4,0	0,040	38.700	0,002	180	61	0,030	25.200	0,001	75	40	0,024	15.390	0,002	50	24
0,6	2,0	0,084	36.400	0,003	250	69	0,063	24.000	0,002	110	45	0,050	14.500	0,002	65	27
0,6	3,0	0,084	36.400	0,003	250	69	0,063	24.000	0,002	110	45	0,050	14.500	0,002	65	27
0,6	4,0	0,048	32.760	0,003	205	62	0,036	21.600	0,002	90	41	0,029	13.050	0,002	55	25
0,6	6,0	0,030	32.760	0,003	205	62	0,023	21.600	0,002	90	41	0,018	13.050	0,002	55	25
0,8	2,0	0,160	36.400	0,003	250	91	0,120	24.000	0,002	110	60	0,096	14.500	0,002	65	36
0,8	4,0	0,112	36.400	0,003	250	91	0,084	24.000	0,002	110	60	0,067	14.500	0,002	65	36
0,8	6,0	0,064	32.760	0,003	205	82	0,048	21.600	0,002	90	54	0,038	13.050	0,002	55	33
0,8	8,0	0,040	32.760	0,003	205	82	0,030	21.600	0,002	90	54	0,024	13.050	0,002	55	33
1,0	3,0	0,200	33.100	0,004	280	104	0,150	21.600	0,003	120	68	0,120	13.200	0,003	70	41
1,0	4,0	0,140	33.100	0,004	280	104	0,105	21.600	0,003	120	68	0,084	13.200	0,003	70	41
1,0	6,0	0,080	29.790	0,004	225	94	0,060	19.440	0,002	95	61	0,048	11.880	0,002	55	37
1,0	8,0	0,080	29.790	0,004	225	94	0,060	19.440	0,002	95	61	0,048	11.880	0,002	55	37
1,0	10,0	0,050	29.790	0,004	225	94	0,038	19.440	0,002	95	61	0,030	11.880	0,002	55	37
1,0	12,0	0,050	26.480	0,003	180	83	0,038	17.280	0,002	75	54	0,030	10.560	0,002	45	33
1,2	4,0	0,168	29.750	0,005	290	112	0,126	18.900	0,003	125	71	0,101	11.700	0,003	70	44
1,2	6,0	0,168	29.750	0,005	290	112	0,126	18.900	0,003	125	71	0,101	11.700	0,003	70	44
1,2	8,0	0,096	26.780	0,004	235	101	0,072	17.010	0,003	100	64	0,058	10.530	0,003	55	40
1,2	10,0	0,060	26.780	0,004	235	101	0,045	17.010	0,003	100	64	0,036	10.530	0,003	55	40
2,0	6,0	0,400	21.600	0,007	310	136	0,300	13.800	0,005	140	87	0,240	8.640	0,005	80	54
2,0	8,0	0,280	21.600	0,007	310	136	0,210	13.800	0,005	140	87	0,168	8.640	0,005	80	54
2,0	10,0	0,280	21.600	0,007	310	136	0,210	13.800	0,005	140	87	0,168	8.640	0,005	80	54
2,0	12,0	0,160	19.440	0,006	250	122	0,120	12.420	0,005	115	78	0,096	7.780	0,004	65	49
2,0	14,0	0,160	19.440	0,006	250	122	0,120	12.420	0,005	115	78	0,096	7.780	0,004	65	49
2,0	16,0	0,160	19.440	0,006	250	122	0,120	12.420	0,005	115	78	0,096	7.780	0,004	65	49
3,0	8,0	0,600	15.900	0,010	330	150	0,450	10.300	0,008	160	97	0,360	6.300	0,006	80	59
3,0	10,0	0,420	15.900	0,010	330	150	0,315	10.300	0,008	160	97	0,252	6.300	0,006	80	59
3,0	12,0	0,420	15.900	0,010	330	150	0,315	10.300	0,008	160	97	0,252	6.300	0,006	80	59
3,0	14,0	0,420	15.900	0,010	330	150	0,315	10.300	0,008	160	97	0,252	6.300	0,006	80	59
3,0	16,0	0,240	14.310	0,009	265	135	0,180	9.270	0,007	130	87	0,144	5.670	0,006	65	53
3,0	20,0	0,240	14.310	0,009	265	135	0,180	9.270	0,007	130	87	0,144	5.670	0,006	65	53
3,0	26,0	0,150	14.310	0,009	265	135	0,113	9.270	0,007	130	87	0,090	5.670	0,006	65	53
4,0	10,0	0,800	12.800	0,016	400	161	0,600	8.200	0,012	200	103	0,480	5.150	0,009	95	65
4,0	12,0	0,800	12.800	0,016	400	161	0,600	8.200	0,012	200	103	0,480	5.150	0,009	95	65
4,0	16,0	0,560	12.800	0,016	400	161	0,420	8.200	0,012	200	103	0,336	5.150	0,009	95	65
4,0	20,0	0,560	12.800	0,016	400	161	0,420	8.200	0,012	200	103	0,336	5.150	0,009	95	65
4,0	26,0	0,320	11.520	0,014	325	145	0,240	7.380	0,011	160	93	0,192	4.640	0,008	78	58
4,0	30,0	0,320	11.520	0,014	325	145	0,240	7.380	0,011	160	93	0,192	4.640	0,008	78	58
6,0	20,0	0,840	9.500	0,032	600	179	0,630	6.000	0,025	300	113	0,504	3.930	0,018	140	74
6,0	30,0	0,840	9.500	0,032	600	179	0,630	6.000	0,025	300	113	0,504	3.930	0,018	140	74
8,0	25,0	1,120	7.200	0,044	640	181	0,840	4.550	0,033	300	114	0,672	3.020	0,023	140	76
10,0	30,0	2,000	6.000	0,053	640	188	1,500	4.000	0,038	300	126	1,200	2.420	0,029	140	76
12,0	32,0	2,400	5.000	0,050	500	188	1,800	3.340	0,040	270	126	1,440	2.000	0,030	120	75
16,0	35,0	3,200	3.720	0,060	450	187	2,400	2.520	0,042	210	127	1,920	1.540	0,031	95	77
20,0	40,0	4,000	3.000	0,055	330	188	3,000	1.950	0,036	140	123	2,400	1.200	0,029	70	75

AFX

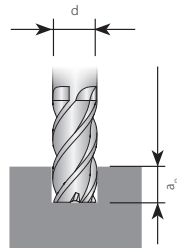

Die Tabellenwerte sind Richtwerte. Es kann notwendig sein, die Werte den jeweiligen Bearbeitungsumständen anzupassen.
The recommended cutting data are only approximate values. It may be necessary to adjust them to each individual machining application.

MATERIAL	Unlegierter Stahl / Non-alloyed steel				Legierter Stahl / Alloy steel				Gehärteter Stahl / Hardened steel			
	Legierter Stahl / Alloy steel				Hochwarmfester Stahl / Heat resistant steel							
	Gusseisen / Cast iron											
Härte / Hardness Zugfestigkeit / Strength	~ HRC 35 ~ 1100 N/mm ²				HRC 35 ~ HRC 45 1110 ~ 1500 N/mm ²				HRC 45 ~ HRC 55 1500 ~ 2000 N/mm ²			
d (mm)	n (U/min)	f _z (mm)	v _f (mm/min)	v _c (m/min)	n (U/min)	f _z (mm)	v _f (mm/min)	v _c (m/min)	n (U/min)	f _z (mm)	v _f (mm/min)	v _c (m/min)
0,1	42.000	0,001	80	13	25.200	0,001	47	8	16.800	0,001	16	5
0,2	42.000	0,001	85	26	25.200	0,001	50	16	16.800	0,001	17	11
0,3	39.000	0,001	90	37	23.400	0,001	54	22	15.600	0,001	18	15
0,4	39.000	0,001	95	49	23.400	0,001	57	29	15.600	0,001	19	20
0,5	36.000	0,002	110	57	21.600	0,002	66	34	14.400	0,001	22	23
0,6	32.000	0,002	125	60	19.200	0,002	76	36	12.800	0,001	25	24
0,7	28.000	0,003	140	62	16.800	0,003	85	37	11.200	0,001	28	25
0,8	25.000	0,003	155	63	15.000	0,003	95	38	10.000	0,002	32	25
0,9	23.500	0,004	165	66	14.100	0,003	98	40	9.400	0,002	33	27
1,0	21.500	0,004	170	68	12.900	0,004	101	41	8.600	0,002	34	27
1,2	18.000	0,005	175	68	10.800	0,005	104	41	7.200	0,002	35	27
1,5	15.000	0,006	180	71	9.000	0,006	107	42	6.000	0,003	36	28
2,0	11.560	0,009	200	73	7.560	0,008	125	48	5.040	0,004	37	32
2,5	10.240	0,010	210	80	6.560	0,010	135	52	4.200	0,005	39	33
3,0	8.920	0,012	220	84	5.560	0,013	145	52	3.360	0,006	42	32
3,5	8.240	0,016	270	91	5.090	0,017	170	56	3.150	0,007	42	35
4,0	7.560	0,021	315	95	4.620	0,021	190	58	2.940	0,007	42	37
4,5	6.930	0,023	325	98	4.200	0,023	195	59	2.630	0,009	47	37
5,0	6.300	0,027	335	99	3.780	0,026	200	59	2.320	0,011	53	36
5,5	5.930	0,030	350	102	3.570	0,030	215	62	2.160	0,013	55	37
6,0	5.560	0,033	370	105	3.360	0,034	230	63	2.000	0,015	58	38
6,5	5.220	0,036	375	107	3.150	0,036	225	64	1.920	0,016	63	39
7,0	4.880	0,039	385	107	2.940	0,037	220	65	1.840	0,018	68	40
7,5	4.540	0,043	390	107	2.730	0,039	215	64	1.760	0,021	74	41
8,0	4.200	0,048	400	106	2.520	0,042	210	63	1.680	0,024	79	42
8,5	3.965	0,049	385	106	2.390	0,042	200	64	1.600	0,023	74	43
9,0	3.730	0,050	375	105	2.260	0,042	190	64	1.520	0,022	68	43
9,5	3.495	0,051	355	104	2.130	0,042	180	64	1.440	0,022	63	43
10,0	3.260	0,053	345	102	2.000	0,043	170	63	1.360	0,023	63	43
10,5	3.130	0,053	330	103	1.920	0,042	160	63	1.310	0,023	61	43
11,0	3.000	0,053	320	104	1.840	0,041	150	64	1.260	0,023	58	44
11,5	2.870	0,053	305	104	1.760	0,040	140	64	1.210	0,024	58	44
12,0	2.740	0,054	295	103	1.680	0,040	135	63	1.160	0,025	58	44
13,0	2.605	0,054	280	106	1.600	0,041	130	65	1.095	0,025	55	45
14,0	2.470	0,054	265	109	1.520	0,041	125	67	1.030	0,024	49	45
15,0	2.335	0,052	245	110	1.440	0,042	120	68	965	0,023	45	45
16,0	2.200	0,052	230	111	1.360	0,042	115	68	900	0,023	42	45
18,0	1.940	0,053	205	110	1.210	0,041	100	68	790	0,023	37	45
20,0	1.680	0,054	180	106	1.060	0,040	84	67	680	0,024	32	43

AFX

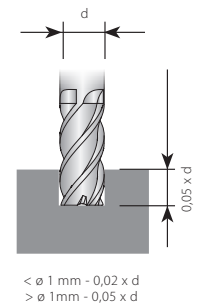
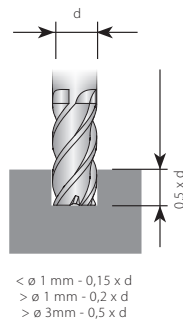

Die Tabellenwerte sind Richtwerte. Es kann notwendig sein, die Werte den jeweiligen Bearbeitungsumständen anzupassen.
The recommended cutting data are only approximate values. It may be necessary to adjust them to each individual machining application.

MATERIAL		Unlegierter Stahl / Non-alloyed steel					Legierter Stahl / Alloy steel					Gehärteter Stahl / Hardened steel			
		Legierter Stahl / Alloy steel					Hochwärmefester Stahl / Heat resistant steel								
Härte / Hardness		~ HRC 35					HRC 35 ~ HRC 45					HRC 45 ~ HRC 55			
Zugfestigkeit / Strength		~ 1100 N/mm ²					1110 ~ 1500 N/mm ²					1500 ~ 2000 N/mm ²			
d	l ₁	n	f _z	v _f	v _c	n	f _z	v _f	v _c	n	f _z	v _f	v _c		
(mm)	(mm)	(U/min)	(mm)	(mm/min)	(m/min)	(U/min)	(mm)	(mm/min)	(m/min)	(U/min)	(mm)	(mm/min)	(m/min)		
1,0	3	16.000	0,002	70	50	12.800	0,002	60	40	8.000	0,002	30	25		
1,0	4	16.000	0,002	70	50	12.800	0,002	60	40	8.000	0,002	30	25		
1,0	6	14.400	0,002	55	45	11.520	0,002	50	36	7.200	0,002	25	23		
1,0	8	14.400	0,002	50	45	11.520	0,002	45	36	7.200	0,002	20	23		
1,0	10	14.400	0,002	50	45	11.520	0,002	45	36	7.200	0,002	20	23		
1,5	6	11.200	0,004	80	53	8.960	0,004	70	42	5.600	0,003	30	26		
1,5	8	10.080	0,003	70	48	8.060	0,004	60	38	5.040	0,003	30	24		
1,5	10	10.080	0,003	65	48	8.060	0,003	55	38	5.040	0,002	25	24		
1,5	12	10.080	0,003	60	48	8.060	0,003	50	38	5.040	0,002	25	24		
1,5	16	8.960	0,003	45	42	7.170	0,003	40	34	4.480	0,002	20	21		
2,0	8	9.070	0,005	85	57	7.260	0,005	70	46	4.540	0,004	35	29		
2,0	10	9.070	0,005	85	57	7.260	0,005	70	46	4.540	0,004	35	29		
2,0	12	8.160	0,004	70	51	6.530	0,005	60	41	4.090	0,004	30	26		
2,0	16	8.160	0,004	60	51	6.530	0,004	50	41	4.090	0,003	25	26		
2,5	10	7.700	0,006	95	60	6.200	0,006	80	49	3.850	0,005	40	30		
2,5	16	6.930	0,005	75	54	5.580	0,006	65	44	3.470	0,004	30	27		
3,0	10	6.350	0,008	100	60	5.150	0,008	85	49	3.170	0,006	40	30		
3,0	12	6.350	0,008	100	60	5.150	0,008	85	49	3.170	0,006	40	30		
3,0	16	5.720	0,008	90	54	4.640	0,008	75	44	2.850	0,007	40	27		
3,0	20	5.720	0,007	80	54	4.640	0,008	70	44	2.850	0,006	35	27		
3,0	26	5.720	0,006	70	54	4.640	0,006	60	44	2.850	0,005	30	27		
4,0	12	5.150	0,012	120	65	4.100	0,012	100	52	2.580	0,010	50	32		
4,0	16	5.150	0,012	120	65	4.100	0,012	100	52	2.580	0,010	50	32		
4,0	20	5.150	0,012	120	65	4.100	0,012	100	52	2.580	0,010	50	32		
4,0	26	4.640	0,010	95	58	3.690	0,012	85	46	2.320	0,009	40	29		
4,0	30	4.640	0,010	95	58	3.690	0,012	85	46	2.320	0,009	40	29		
5,0	20	4.400	0,017	150	69	3.480	0,018	125	55	2.280	0,012	55	36		
5,0	25	4.400	0,017	150	69	3.480	0,018	125	55	2.280	0,012	55	36		
5,0	30	3.960	0,015	120	62	3.130	0,016	100	49	2.050	0,011	45	32		
5,0	40	3.960	0,014	110	62	3.130	0,014	90	49	2.050	0,010	40	32		
6,0	15	3.800	0,024	180	72	3.050	0,025	150	57	1.970	0,018	70	37		
6,0	20	3.800	0,024	180	72	3.050	0,025	150	57	1.970	0,018	70	37		
6,0	25	3.800	0,024	180	72	3.050	0,025	150	57	1.970	0,018	70	37		
6,0	30	3.800	0,020	155	72	3.050	0,021	130	57	1.970	0,015	60	37		
6,0	35	3.420	0,020	140	64	2.750	0,021	115	52	1.770	0,016	55	33		
6,0	40	3.420	0,018	120	64	2.750	0,018	100	52	1.770	0,014	50	33		
6,0	45	3.420	0,018	120	64	2.750	0,018	100	52	1.770	0,014	50	33		
8,0	25	2.880	0,033	190	72	2.280	0,033	150	57	1.510	0,023	70	38		
8,0	30	2.880	0,033	190	72	2.280	0,033	150	57	1.510	0,023	70	38		
8,0	35	2.880	0,033	190	72	2.280	0,033	150	57	1.510	0,023	70	38		
8,0	40	2.880	0,028	160	72	2.280	0,027	125	57	1.510	0,020	60	38		
8,0	45	2.590	0,028	145	65	2.050	0,028	115	52	1.360	0,020	55	34		
8,0	50	2.590	0,025	130	65	2.050	0,024	100	52	1.360	0,018	50	34		
10,0	30	2.450	0,039	190	77	2.000	0,038	150	63	1.210	0,029	70	38		
10,0	35	2.450	0,039	190	77	2.000	0,038	150	63	1.210	0,029	70	38		
10,0	40	2.450	0,039	190	77	2.000	0,038	150	63	1.210	0,029	70	38		
10,0	45	2.450	0,033	160	77	2.000	0,031	125	63	1.210	0,025	60	38		
10,0	50	2.450	0,033	160	77	2.000	0,031	125	63	1.210	0,025	60	38		
10,0	60	2.210	0,029	130	69	1.800	0,028	100	57	1.090	0,023	50	34		
12,0	35	2.000	0,038	150	75	1.670	0,040	135	63	1.010	0,027	55	38		
12,0	40	2.000	0,038	150	75	1.670	0,040	135	63	1.010	0,027	55	38		
12,0	45	2.000	0,033	130	75	1.670	0,034	115	63	1.010	0,022	45	38		
12,0	50	2.000	0,033	130	75	1.670	0,034	115	63	1.010	0,022	45	38		
12,0	55	2.000	0,033	130	75	1.670	0,034	115	63	1.010	0,022	45	38		
12,0	60	2.000	0,028	110	75	1.670	0,030	110	63	1.010	0,020	40	38		
14,0	50	1.850	0,034	125	81	1.480	0,034	100	65	910	0,025	45	40		
16,0	40	1.700	0,041	140	85	1.280	0,041	105	64	800	0,031	50	40		
16,0	50	1.700	0,041	140	85	1.280	0,041	105	64	800	0,031	50	40		
18,0	50	1.450	0,041	120	82	1.120	0,040	90	63	700	0,029	40	40		
20,0	90	1.220	0,031	75	77	950	0,029	55	60	600	0,021	25	38		
20,0	110	1.100	0,032	70	69	860	0,029	50	45	540	0,023	25	34		

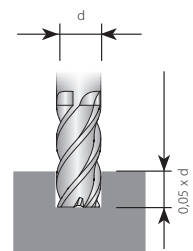
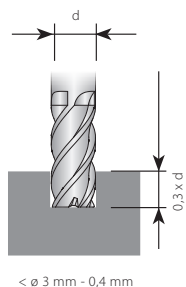

Die Tabellenwerte sind Richtwerte. Es kann notwendig sein, die Werte den jeweiligen Bearbeitungsumständen anzupassen.
The recommended cutting data are only approximate values. It may be necessary to adjust them to each individual machining application.

Empfohlene Schnittwerte AFX50121-...R...

Ausführung AFX

Recommended cutting data AFX50121-...R...

Design AFX

MATERIAL	Unlegierter Stahl / Non-alloyed steel				Legierter Stahl / Alloy steel				Gehärteter Stahl / Hardened steel			
	Legierter Stahl / Alloy steel				Hochwarmfester Stahl / Heat resistant steel							
	Gusseisen / Cast iron											
Härte / Hardness Zugfestigkeit / Strength	~ HRC 35 ~ 1100 N/mm ²				HRC 35 ~ HRC 45 1110 ~ 1500 N/mm ²				HRC 45 ~ HRC 55 1500 ~ 2000 N/mm ²			
d (mm)	n (U/min)	f _z (mm)	v _f (mm/min)	v _c (m/min)	n (U/min)	f _z (mm)	v _f (mm/min)	v _c (m/min)	n (U/min)	f _z (mm)	v _f (mm/min)	v _c (m/min)
1,0	27.600	0,004	240	87	18.000	0,003	100	57	11.000	0,003	60	35
1,5	22.000	0,006	250	104	13.500	0,004	110	64	8.500	0,004	60	40
2,0	18.000	0,007	260	113	11.560	0,005	120	73	7.200	0,005	70	45
3,0	13.240	0,011	280	125	8.560	0,008	140	81	5.280	0,007	70	50
4,0	10.720	0,016	340	135	6.820	0,012	170	86	4.300	0,009	80	54
5,0	9.160	0,023	420	144	5.800	0,017	200	91	3.800	0,013	100	60
6,0	7.900	0,032	500	149	5.040	0,025	250	95	3.280	0,018	120	62
8,0	6.000	0,045	540	151	3.800	0,033	250	96	2.520	0,024	120	63
10,0	5.040	0,054	540	158	3.280	0,038	250	103	2.020	0,030	120	63
12,0	4.120	0,051	420	155	2.780	0,041	230	105	1.680	0,030	100	63
16,0	3.100	0,058	360	156	2.100	0,040	170	106	1.280	0,031	80	64
20,0	2.520	0,056	280	158	1.640	0,037	120	103	1.000	0,030	60	63

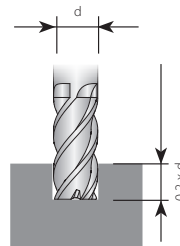

Die Tabellenwerte sind Richtwerte. Es kann notwendig sein, die Werte den jeweiligen Bearbeitungsumständen anzupassen.
The recommended cutting data are only approximate values. It may be necessary to adjust them to each individual machining application.

MATERIAL	Unlegierter Stahl / Non-alloyed steel							Legierter Stahl / Alloy steel					Gehärteter Stahl / Hardened steel					
	Legierter Stahl / Alloy steel							Hochwarmfester Stahl / Heat resistant steel										
	Gusseisen / Cast iron																	
Härte / Hardness		~ HRC 35							HRC 35 ~ HRC 45					HRC 45 ~ HRC 55				
Zugfestigkeit / Strength		~ 1100 N/mm ²							1110 ~ 1500 N/mm ²					1500 ~ 2000 N/mm ²				
d	l ₂	a _p	n	f _z	v _f	v _c	a _p	n	f _z	v _f	v _c	a _p	n	f _z	v _f	v _c		
(mm)	(mm)	(mm)	(U/min)	(mm)	(mm/min)	(m/min)	(mm)	(U/min)	(mm)	(mm/min)	(m/min)	(mm)	(U/min)	(mm)	(mm/min)	(m/min)		
0,2	1,0	0,013	38.500	0,005	380	24	0,010	36.300	0,004	270	23	0,007	32.100	0,003	200	20		
0,3	1,5	0,019	34.200	0,006	390	32	0,015	32.300	0,004	270	30	0,011	28.500	0,004	230	27		
0,3	2,0	0,011	30.780	0,005	315	29	0,008	29.070	0,004	220	27	0,006	25.650	0,004	185	24		
0,4	1,0	0,036	27.400	0,010	540	34	0,028	25.800	0,007	380	32	0,020	22.800	0,006	280	29		
0,4	1,5	0,025	27.400	0,010	540	34	0,020	25.800	0,007	380	32	0,014	22.800	0,006	280	29		
0,4	2,0	0,025	27.400	0,010	540	34	0,020	25.800	0,007	380	32	0,014	22.800	0,006	280	29		
0,4	3,0	0,014	24.660	0,009	435	31	0,011	23.220	0,007	310	29	0,008	20.520	0,005	225	26		
0,4	4,0	0,009	24.660	0,009	435	31	0,007	23.220	0,007	310	29	0,005	20.520	0,005	225	26		
0,4	5,0	0,009	21.920	0,008	345	28	0,007	20.640	0,006	245	26	0,005	18.240	0,005	180	23		
0,5	2,0	0,032	27.400	0,010	540	43	0,025	25.800	0,008	425	41	0,018	22.800	0,006	285	36		
0,5	3,0	0,018	24.660	0,009	435	39	0,014	23.220	0,007	345	36	0,010	20.520	0,006	230	32		
0,5	4,0	0,018	24.660	0,009	435	39	0,014	23.220	0,007	345	36	0,010	20.520	0,006	230	32		
0,5	5,0	0,011	24.660	0,009	435	39	0,009	23.220	0,007	345	36	0,006	20.520	0,006	230	32		
0,5	6,0	0,011	21.920	0,008	345	34	0,009	20.640	0,007	270	32	0,006	18.240	0,005	180	29		
0,6	2,0	0,038	27.400	0,014	775	52	0,029	25.800	0,011	545	49	0,021	22.800	0,009	405	43		
0,6	3,0	0,038	27.400	0,014	775	52	0,029	25.800	0,011	545	49	0,021	22.800	0,009	405	43		
0,6	4,0	0,022	24.660	0,013	630	46	0,017	23.220	0,009	440	44	0,012	20.520	0,008	330	39		
0,6	5,0	0,014	24.660	0,013	630	46	0,011	23.220	0,009	440	44	0,008	20.520	0,008	330	39		
0,6	6,0	0,014	24.660	0,013	630	46	0,011	23.220	0,009	440	44	0,008	20.520	0,008	330	39		
0,6	8,0	0,008	21.920	0,011	495	41	0,006	20.640	0,008	350	39	0,005	18.240	0,007	260	34		
0,6	10,0	0,005	16.440	0,010	325	31	0,004	15.480	0,007	230	29	0,003	13.680	0,006	170	26		
0,8	2,0	0,072	27.400	0,014	775	69	0,056	25.800	0,012	605	65	0,040	22.800	0,010	450	57		
0,8	3,0	0,050	27.400	0,014	775	69	0,039	25.800	0,012	605	65	0,028	22.800	0,010	450	57		
0,8	4,0	0,050	27.400	0,014	775	69	0,039	25.800	0,012	605	65	0,028	22.800	0,010	450	57		
0,8	5,0	0,029	24.660	0,013	630	62	0,022	23.220	0,011	490	58	0,016	20.520	0,009	365	52		
0,8	6,0	0,029	24.660	0,013	630	62	0,022	23.220	0,011	490	58	0,016	20.520	0,009	365	52		
0,8	8,0	0,018	24.660	0,013	630	62	0,014	23.220	0,011	490	58	0,010	20.520	0,009	365	52		
0,8	10,0	0,018	21.920	0,011	495	55	0,014	20.640	0,009	385	52	0,010	18.240	0,008	290	46		
1,0	3,0	0,090	24.600	0,021	1045	77	0,070	23.300	0,019	890	73	0,050	20.500	0,016	665	64		
1,0	4,0	0,063	24.600	0,021	1045	77	0,049	23.300	0,019	890	73	0,035	20.500	0,016	665	64		
1,0	5,0	0,063	24.600	0,021	1045	77	0,049	23.300	0,019	890	73	0,035	20.500	0,016	665	64		
1,0	6,0	0,036	22.140	0,019	845	70	0,028	20.970	0,017	720	66	0,020	18.450	0,015	540	58		
1,0	8,0	0,036	22.140	0,019	845	70	0,028	20.970	0,017	720	66	0,020	18.450	0,015	540	58		
1,0	10,0	0,023	22.140	0,019	845	70	0,018	20.970	0,017	720	66	0,013	18.450	0,015	540	58		
1,0	12,0	0,023	19.680	0,017	670	62	0,018	18.640	0,015	570	59	0,013	16.400	0,013	425	52		
1,0	14,0	0,014	19.680	0,017	670	62	0,011	18.640	0,015	570	59	0,008	16.400	0,013	425	52		
1,0	16,0	0,014	14.760	0,015	440	46	0,011	13.980	0,013	375	44	0,008	12.300	0,011	280	39		
1,0	20,0	0,009	14.760	0,015	440	46	0,007	13.980	0,013	375	44	0,005	12.300	0,011	280	39		
1,2	6,0	0,076	21.900	0,021	930	83	0,059	20.700	0,017	720	78	0,042	18.200	0,013	485	69		
1,2	8,0	0,043	19.710	0,019	755	74	0,034	18.630	0,016	585	70	0,024	16.380	0,012	395	62		
1,2	10,0	0,027	19.710	0,019	755	74	0,021	18.630	0,016	585	70	0,015	16.380	0,012	395	62		
1,4	6,0	0,088	19.200	0,021	815	84	0,069	18.100	0,016	570	80	0,049	16.000	0,013	425	70		
1,4	8,0	0,050	17.280	0,019	660	76	0,039	16.290	0,014	460	72	0,028	14.400	0,012	345	63		
1,5	4,0	0,135	19.200	0,024	905	90	0,105	18.100	0,018	635	85	0,075	16.000	0,015	475	75		
1,5	6,0	0,095	19.200	0,024	905	90	0,074	18.100	0,018	635	85	0,053	16.000	0,015	475	75		
1,5	8,0	0,054	17.280	0,021	735	81	0,042	16.290	0,016	515	77	0,030	14.400	0,013	385	68		
1,5	10,0	0,054	17.280	0,021	735	81	0,042	16.290	0,016	515	77	0,030	14.400	0,013	385	68		
1,5	12,0	0,054	17.280	0,021	735	81	0,042	16.290	0,016	515	77	0,030	14.400	0,013	385	68		
1,5	14,0	0,034	17.280	0,021	735	81	0,026	16.290	0,016	515	77	0,019	14.400	0,013	385	68		
1,5	16,0	0,034	15.360	0,019	580	72	0,026	14.480	0,014	405	68	0,019	12.800	0,012	305	60		
1,5	20,0	0,020	15.360	0,019	580	72	0,016	14.480	0,014	405	68	0,011	12.800	0,012	305	60		
1,8	8,0	0,113	17.800	0,024	840	101	0,088	16.800	0,019	655	95	0,063	14.800	0,017	490	84		
1,8	10,0	0,065	16.020	0,021	680	91	0,050	15.120	0,018	530	86	0,036	13.320	0,015	395	75		
1,8	12,0	0,065	16.020	0,021	680	91	0,050	15.120	0,018	530	86	0,036	13.320	0,015	395	75		

AFX

Die Tabellenwerte sind Richtwerte. Es kann notwendig sein, die Werte den jeweiligen Bearbeitungsumständen anzupassen.
The recommended cutting data are only approximate values. It may be necessary to adjust them to each individual machining application.

MATERIAL		Unlegierter Stahl / Non-alloyed steel					Legierter Stahl / Alloy steel					Gehärteter Stahl / Hardened steel				
Härte / Hardness Zugfestigkeit / Strength		Legierter Stahl / Alloy steel Gusseisen / Cast iron ~ HRC 35 ~ 1100 N/mm ²					Hochwarmfester Stahl / Heat resistant steel HRC 35 ~ HRC 45 1110 ~ 1500 N/mm ²					HRC 45 ~ HRC 55 1500 ~ 2000 N/mm ²				
d	l ₂	a _p	n	f _z	v _f	v _c	a _p	n	f _z	v _f	v _c	a _p	n	f _z	v _f	v _c
(mm)	(mm)	(mm)	(U/min)	(mm)	(mm/min)	(m/min)	(mm)	(U/min)	(mm)	(mm/min)	(m/min)	(mm)	(U/min)	(mm)	(mm/min)	(m/min)
2,0	6,0	0,180	14.400	0,028	820	90	0,140	13.600	0,023	620	85	0,100	12.000	0,020	475	75
2,0	8,0	0,126	14.400	0,028	820	90	0,098	13.600	0,023	620	85	0,070	12.000	0,020	475	75
2,0	10,0	0,126	14.400	0,028	820	90	0,098	13.600	0,023	620	85	0,070	12.000	0,020	475	75
2,0	12,0	0,072	12.960	0,026	665	81	0,056	12.240	0,020	500	77	0,040	10.800	0,018	385	68
2,0	14,0	0,072	12.960	0,026	665	81	0,056	12.240	0,020	500	77	0,040	10.800	0,018	385	68
2,0	16,0	0,072	12.960	0,026	665	81	0,056	12.240	0,020	500	77	0,040	10.800	0,018	385	68
2,0	20,0	0,045	12.960	0,026	665	81	0,035	12.240	0,020	500	77	0,025	10.800	0,018	385	68
2,5	8,0	0,158	12.300	0,039	970	97	0,123	11.600	0,029	680	91	0,088	10.300	0,025	510	81
2,5	12,0	0,158	12.300	0,039	970	97	0,123	11.600	0,029	680	91	0,088	10.300	0,025	510	81
2,5	16,0	0,090	11.070	0,035	785	87	0,070	10.440	0,026	550	82	0,050	9.270	0,022	415	73
2,5	20,0	0,090	11.070	0,035	785	87	0,070	10.440	0,026	550	82	0,050	9.270	0,022	415	73
3,0	8,0	0,270	10.900	0,039	860	103	0,210	10.300	0,029	605	97	0,150	6.600	0,034	450	62
3,0	10,0	0,189	10.900	0,039	860	103	0,147	10.300	0,029	605	97	0,105	6.600	0,034	450	62
3,0	12,0	0,189	10.900	0,039	860	103	0,147	10.300	0,029	605	97	0,105	6.600	0,034	450	62
3,0	14,0	0,189	10.900	0,039	860	103	0,147	10.300	0,029	605	97	0,105	6.600	0,034	450	62
3,0	16,0	0,108	9.810	0,035	695	92	0,084	9.270	0,026	490	87	0,060	5.940	0,031	365	56
3,0	18,0	0,108	9.810	0,035	695	92	0,084	9.270	0,026	490	87	0,060	5.940	0,031	365	56
3,0	20,0	0,108	9.810	0,035	695	92	0,084	9.270	0,026	490	87	0,060	5.940	0,031	365	56
3,0	26,0	0,068	9.810	0,035	695	92	0,053	9.270	0,026	490	87	0,038	5.940	0,031	365	56
4,0	10,0	0,360	8.000	0,081	1300	101	0,280	7.600	0,076	1160	96	0,200	6.700	0,057	770	84
4,0	12,0	0,360	8.000	0,081	1300	101	0,280	7.600	0,076	1160	96	0,200	6.700	0,057	770	84
4,0	16,0	0,252	8.000	0,081	1300	101	0,196	7.600	0,076	1160	96	0,140	6.700	0,057	770	84
4,0	18,0	0,252	8.000	0,081	1300	101	0,196	7.600	0,076	1160	96	0,140	6.700	0,057	770	84
4,0	20,0	0,252	8.000	0,081	1300	101	0,196	7.600	0,076	1160	96	0,140	6.700	0,057	770	84
4,0	26,0	0,144	7.200	0,073	1055	90	0,112	6.840	0,069	940	86	0,080	6.030	0,052	625	76
4,0	30,0	0,144	7.200	0,073	1055	90	0,112	6.840	0,069	940	86	0,080	6.030	0,052	625	76
5,0	20,0	0,315	6.400	0,090	1155	101	0,245	6.100	0,074	900	96	0,175	5.400	0,056	605	85
5,0	30,0	0,180	5.760	0,081	935	90	0,140	5.790	0,066	730	86	0,100	4.860	0,050	490	76
5,0	35,0	0,180	5.760	0,081	935	90	0,140	5.790	0,066	730	86	0,100	4.860	0,050	490	76
5,0	40,0	0,180	5.760	0,081	935	90	0,140	5.790	0,066	730	86	0,100	4.860	0,050	490	76
5,0	50,0	0,113	5.760	0,081	935	90	0,088	5.790	0,066	730	86	0,063	4.860	0,050	490	76
6,0	15,0	0,540	5.300	0,100	1055	100	0,420	5.000	0,082	820	94	0,300	4.400	0,063	550	83
6,0	20,0	0,378	5.300	0,100	1055	100	0,294	5.000	0,082	820	94	0,210	4.400	0,063	550	83
6,0	30,0	0,378	5.300	0,100	1055	100	0,294	5.000	0,082	820	94	0,210	4.400	0,063	550	83
8,0	25,0	0,504	4.000	0,119	950	101	0,392	3.800	0,099	750	96	0,280	3.300	0,076	500	83
10,0	30,0	0,900	3.200	0,141	900	101	0,700	3.050	0,111	680	96	0,500	2.630	0,076	400	83
10,0	45,0	0,630	3.200	0,141	900	101	0,490	3.050	0,111	680	96	0,350	2.630	0,076	400	83
12,0	35,0	1,080	2.650	0,151	800	100	0,840	2.520	0,119	600	95	0,600	2.180	0,080	350	82
12,0	50,0	0,756	2.650	0,151	800	100	0,588	2.520	0,119	600	95	0,420	2.180	0,080	350	82

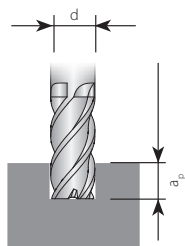

Schnitttiefe in einem Durchgang
Depth of cut in one pass

Die Tabellenwerte sind Richtwerte. Es kann notwendig sein, die Werte den jeweiligen Bearbeitungsumständen anzupassen.
The recommended cutting data are only approximate values. It may be necessary to adjust them to each individual machining application.

MATERIAL		Unlegierter Stahl / Non-alloyed steel Legierter Stahl / Alloy steel Gusseisen / Cast iron				Legierter Stahl / Alloy steel Hochwarmfester Stahl / Heat resistant steel				Gehärteter Stahl / Hardened steel			
Härte / Hardness Zugfestigkeit / Strength		~ HRc 35 ~ 1100 N/mm ²				HRc 35 ~ HRc 45 1110 ~ 1500 N/mm ²				HRc 45 ~ HRc 55 1500 ~ 2000 N/mm ²			
d	R	n	f _z	v _f	v _c	n	f _z	v _f	v _c	n	f _z	v _f	v _c
(mm)	(mm)	(U/min)	(mm)	(mm/min)	(m/min)	(U/min)	(mm)	(mm/min)	(m/min)	(U/min)	(mm)	(mm/min)	(m/min)
0,1	0,05	40.000	0,007	550	13	40.000	0,006	500	13	33.000	0,006	400	10
0,2	0,1	30.000	0,012	720	19	30.000	0,011	630	19	27.000	0,011	575	17
0,3	0,15	30.000	0,015	900	28	30.000	0,014	810	28	27.000	0,013	720	25
0,4	0,2	30.000	0,019	1140	38	30.000	0,017	1020	38	27.000	0,017	900	34
0,5	0,25	30.000	0,024	1440	47	30.000	0,021	1260	47	27.000	0,021	1140	42
0,6	0,3	30.000	0,029	1740	57	30.000	0,025	1500	57	27.000	0,024	1320	51
0,7	0,35	30.000	0,034	2040	66	30.000	0,029	1740	66	27.000	0,029	1560	59
0,8	0,4	30.000	0,039	2340	75	30.000	0,033	1980	75	27.000	0,033	1800	68
0,9	0,45	30.000	0,044	2610	85	30.000	0,038	2250	85	27.000	0,038	2040	76
1,0	0,5	30.000	0,048	2880	94	30.000	0,042	2520	94	27.000	0,042	2280	85
1,2	0,6	30.000	0,051	3060	113	28.800	0,045	2580	109	25.800	0,045	2310	97
1,5	0,75	30.000	0,054	3240	141	28.800	0,047	2700	136	25.800	0,047	2400	122
2,0	1,0	29.820	0,057	3420	187	28.680	0,050	2880	180	24.000	0,050	2400	151
2,5	1,25	23.800	0,074	3510	187	22.900	0,066	3030	180	19.200	0,063	2400	151
3,0	1,5	19.860	0,091	3600	187	19.080	0,083	3180	180	16.000	0,075	2400	151
4,0	2,0	14.900	0,121	3600	187	14.340	0,111	3180	180	12.000	0,100	2400	151
5,0	2,5	11.160	0,156	3480	175	10.680	0,138	2940	168	9.000	0,125	2250	141
6,0	3,0	8.340	0,174	2910	157	8.040	0,153	2460	152	6.600	0,141	1860	124
7,0	3,5	7.220	0,184	2650	159	6.960	0,159	2220	153	5.800	0,147	1700	128
8,0	4,0	6.660	0,189	2520	167	6.420	0,164	2100	161	5.400	0,150	1620	136
9,0	4,5	5.940	0,195	2320	168	5.700	0,170	1940	161	4.800	0,156	1500	136
10,0	5,0	5.580	0,199	2220	175	5.340	0,174	1860	168	4.500	0,160	1440	141
11,0	5,5	4.875	0,205	1995	168	4.670	0,180	1680	161	3.930	0,164	1290	136
12,0	6,0	4.170	0,212	1770	157	4.000	0,188	1500	151	3.360	0,170	1140	127
13,0	6,5	3.960	0,218	1725	162	3.800	0,197	1500	155	3.200	0,173	1110	131
14,0	7,0	3.750	0,224	1680	165	3.600	0,208	1500	158	3.030	0,178	1080	133
16,0	8,0	3.340	0,238	1590	168	3.210	0,206	1320	161	2.700	0,189	1020	136
20,0	10,0	2.670	0,264	1410	168	2.580	0,227	1170	162	2.160	0,208	900	136

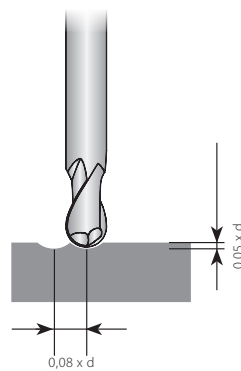

Die Tabellenwerte sind Richtwerte. Es kann notwendig sein, die Werte den jeweiligen Bearbeitungsumständen anzupassen.
The recommended cutting data are only approximate values. It may be necessary to adjust them to each individual machining application.

MATERIAL		Unlegierter Stahl / Non-alloyed steel					Legierter Stahl / Alloy steel					Gehärteter Stahl / Hardened steel				
Härte / Hardness Zugfestigkeit / Strength		~ HRc 35 ~ 1100 N/mm ²					HRc 35 ~ HRc 45 1110 ~ 1500 N/mm ²					HRc 45 ~ HRc 55 1500 ~ 2000 N/mm ²				
d (mm)	l ₂ (mm)	a _p (mm)	n (U/min)	f _z (mm)	v _f (mm/min)	v _c (m/min)	a _p (mm)	n (U/min)	f _z (mm)	v _f (mm/min)	v _c (m/min)	a _p (mm)	n (U/min)	f _z (mm)	v _f (mm/min)	v _c (m/min)
0,2	0,5	0,018	50.000	0,003	335	31	0,014	50.000	0,003	310	31	0,010	43.200	0,003	260	27
0,2	1,0	0,013	50.000	0,003	335	31	0,010	50.000	0,003	310	31	0,007	43.200	0,003	260	27
0,2	1,5	0,007	45.000	0,003	270	28	0,006	45.000	0,003	250	28	0,004	38.880	0,003	210	24
0,2	3,0	0,003	45.000	0,003	270	28	0,003	45.000	0,003	250	28	0,002	38.880	0,003	210	24
0,3	1,0	0,019	50.000	0,005	475	47	0,015	50.000	0,004	430	47	0,011	42.800	0,004	365	40
0,3	1,5	0,019	50.000	0,005	475	47	0,015	50.000	0,004	430	47	0,011	42.800	0,004	365	40
0,3	2,0	0,011	45.000	0,004	385	42	0,008	45.000	0,004	350	42	0,006	38.520	0,004	295	36
0,3	3,0	0,007	45.000	0,004	385	42	0,005	45.000	0,004	350	42	0,004	38.520	0,004	295	36
0,4	1,0	0,036	41.000	0,006	490	52	0,028	38.800	0,005	425	49	0,020	34.200	0,005	340	43
0,4	1,5	0,025	41.000	0,006	490	52	0,020	38.800	0,005	425	49	0,014	34.200	0,005	340	43
0,4	2,0	0,025	41.000	0,006	490	52	0,020	38.800	0,005	425	49	0,014	34.200	0,005	340	43
0,4	3,0	0,014	36.900	0,005	395	46	0,011	34.920	0,005	345	44	0,008	30.780	0,004	275	39
0,4	4,0	0,009	36.900	0,005	395	46	0,007	34.920	0,005	345	44	0,005	30.780	0,004	275	39
0,4	5,0	0,009	32.800	0,005	315	41	0,007	31.040	0,004	270	39	0,005	27.360	0,004	220	34
0,4	6,0	0,005	32.800	0,005	315	41	0,004	31.040	0,004	270	39	0,003	27.360	0,004	220	34
0,5	1,0	0,045	34.200	0,010	685	54	0,035	32.300	0,009	580	51	0,025	28.500	0,009	515	45
0,5	2,0	0,032	34.200	0,010	685	54	0,025	32.300	0,009	580	51	0,018	28.500	0,009	515	45
0,5	3,0	0,018	30.780	0,009	555	48	0,014	29.070	0,008	470	46	0,010	25.650	0,008	415	40
0,5	4,0	0,018	30.780	0,009	555	48	0,014	29.070	0,008	470	46	0,010	25.650	0,008	415	40
0,5	5,0	0,011	30.780	0,009	555	48	0,009	29.070	0,008	470	46	0,006	25.650	0,008	415	40
0,5	6,0	0,011	27.360	0,008	440	43	0,009	25.840	0,007	370	41	0,006	22.800	0,007	330	36
0,5	8,0	0,007	20.520	0,007	290	32	0,005	19.380	0,006	245	30	0,004	17.100	0,006	215	27
0,5	10,0	0,005	20.520	0,007	290	32	0,004	19.380	0,006	245	30	0,003	17.100	0,006	215	27
0,6	1,0	0,038	34.200	0,015	1025	64	0,029	32.300	0,013	840	61	0,021	28.500	0,012	685	54
0,6	2,0	0,038	34.200	0,015	1025	64	0,029	32.300	0,013	840	61	0,021	28.500	0,012	685	54
0,6	3,0	0,038	34.200	0,015	1025	64	0,029	32.300	0,013	840	61	0,021	28.500	0,012	685	54
0,6	4,0	0,022	30.780	0,013	830	58	0,017	29.070	0,012	680	55	0,012	25.650	0,011	555	48
0,6	5,0	0,014	30.780	0,013	830	58	0,011	29.070	0,012	680	55	0,008	25.650	0,011	555	48
0,6	6,0	0,014	30.780	0,013	830	58	0,011	29.070	0,012	680	55	0,008	25.650	0,011	555	48
0,6	8,0	0,008	27.360	0,012	655	52	0,006	25.840	0,010	540	49	0,005	22.800	0,010	440	43
0,6	10,0	0,005	20.520	0,010	430	39	0,004	19.380	0,009	355	37	0,003	17.100	0,008	290	32
0,6	12,0	0,005	20.520	0,010	430	39	0,004	19.380	0,009	355	37	0,003	17.100	0,008	290	32
0,7	6,0	0,016	30.780	0,015	915	68	0,012	29.070	0,013	755	64	0,009	25.650	0,012	620	56
0,8	2,0	0,072	34.200	0,018	1230	86	0,056	32.300	0,016	1035	81	0,040	28.500	0,015	855	72
0,8	3,0	0,050	34.200	0,018	1230	86	0,039	32.300	0,016	1035	81	0,028	28.500	0,015	855	72
0,8	4,0	0,050	34.200	0,018	1230	86	0,039	32.300	0,016	1035	81	0,028	28.500	0,015	855	72
0,8	5,0	0,029	30.780	0,016	995	77	0,022	29.070	0,014	840	73	0,016	25.650	0,014	695	64
0,8	6,0	0,029	30.780	0,016	995	77	0,022	29.070	0,014	840	73	0,016	25.650	0,014	695	64
0,8	8,0	0,018	30.780	0,016	995	77	0,014	29.070	0,014	840	73	0,010	25.650	0,014	695	64
0,8	10,0	0,018	27.360	0,014	785	69	0,014	25.840	0,013	660	65	0,010	22.800	0,012	545	57
1,0	5,0	0,063	30.800	0,025	1540	97	0,049	29.100	0,023	1310	91	0,035	25.700	0,021	1075	81
1,0	6,0	0,036	27.720	0,022	1245	87	0,028	26.190	0,020	1060	82	0,020	23.130	0,019	870	73
1,0	8,0	0,036	27.720	0,022	1245	87	0,028	26.190	0,020	1060	82	0,020	23.130	0,019	870	73

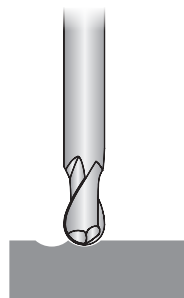

Schnitttiefe in einem Durchgang
Depth of cut in one pass

Die Tabellenwerte sind Richtwerte. Es kann notwendig sein, die Werte den jeweiligen Bearbeitungsumständen anzupassen.
The recommended cutting data are only approximate values. It may be necessary to adjust them to each individual machining application.

Empfohlene Schnittwerte AFX52021-...

Ausführung AFX

Recommended cutting data AFX52021-...

Design AFX

MATERIAL		Unlegierter Stahl / Non-alloyed steel					Legierter Stahl / Alloy steel					Gehärteter Stahl / Hardened steel				
		Legierter Stahl / Alloy steel					Hochwarmfester Stahl / Heat resistant steel									
Härte / Hardness		~ HRc 35					HRc 35 ~ HRc 45					HRc 45 ~ HRc 55				
Zugfestigkeit / Strength		~ 1100 N/mm ²					1110 ~ 1500 N/mm ²					1500 ~ 2000 N/mm ²				
d	l ₂	a _p	n	f _z	v _f	v _c	a _p	n	f _z	v _f	v _c	a _p	n	f _z	v _f	v _c
(mm)	(mm)	(mm)	(U/min)	(mm)	(mm/min)	(m/min)	(mm)	(U/min)	(mm)	(mm/min)	(m/min)	(mm)	(U/min)	(mm)	(mm/min)	(m/min)
2,0	8	0,126	18.000	0,050	1795	113	0,098	17.000	0,045	1525	107	0,070	15.000	0,043	1285	94
2,0	10	0,126	18.000	0,050	1795	113	0,098	17.000	0,045	1525	107	0,070	15.000	0,043	1285	94
3,0	8	0,270	13.700	0,075	2050	129	0,210	12.900	0,067	1730	122	0,150	11.400	0,063	1435	107
3,0	10	0,189	13.700	0,075	2050	129	0,147	12.900	0,067	1730	122	0,105	11.400	0,063	1435	107
3,0	12	0,189	13.700	0,075	2050	129	0,147	12.900	0,067	1730	122	0,105	11.400	0,063	1435	107
3,0	14	0,189	13.700	0,075	2050	129	0,147	12.900	0,067	1730	122	0,105	11.400	0,063	1435	107
3,0	16	0,108	12.330	0,067	1660	116	0,084	11.610	0,060	1400	109	0,060	10.260	0,057	1160	97
3,0	18	0,108	12.330	0,067	1660	116	0,084	11.610	0,060	1400	109	0,060	10.260	0,057	1160	97
3,0	20	0,108	12.330	0,067	1660	116	0,084	11.610	0,060	1400	109	0,060	10.260	0,057	1160	97
3,0	26	0,068	12.330	0,067	1660	116	0,053	11.610	0,060	1400	109	0,038	10.260	0,057	1160	97
3,0	30	0,068	12.330	0,067	1660	116	0,053	11.610	0,060	1400	109	0,038	10.260	0,057	1160	97
3,0	35	0,068	10.960	0,060	1310	103	0,053	10.320	0,054	1105	97	0,038	9.120	0,050	920	86
4,0	10	0,360	9.800	0,100	1965	123	0,280	9.300	0,090	1670	117	0,200	8.200	0,085	1395	103
4,0	12	0,360	9.800	0,100	1965	123	0,280	9.300	0,090	1670	117	0,200	8.200	0,085	1395	103
4,0	14	0,252	9.800	0,100	1965	123	0,196	9.300	0,090	1670	117	0,140	8.200	0,085	1395	103
4,0	16	0,252	9.800	0,100	1965	123	0,196	9.300	0,090	1670	117	0,140	8.200	0,085	1395	103
4,0	18	0,252	9.800	0,100	1965	123	0,196	9.300	0,090	1670	117	0,140	8.200	0,085	1395	103
4,0	20	0,252	9.800	0,100	1965	123	0,196	9.300	0,090	1670	117	0,140	8.200	0,085	1395	103
4,0	26	0,144	8.820	0,090	1590	111	0,122	8.370	0,081	1355	105	0,080	7.380	0,077	1130	93
4,0	30	0,144	8.820	0,090	1590	111	0,122	8.370	0,081	1355	105	0,080	7.380	0,077	1130	93
4,0	35	0,090	8.820	0,090	1590	111	0,070	8.370	0,081	1355	105	0,050	7.380	0,077	1130	93
4,0	40	0,090	8.820	0,090	1590	111	0,070	8.370	0,081	1355	105	0,050	7.380	0,077	1130	93
5,0	30	0,180	6.930	0,108	1495	109	0,140	6.570	0,090	1180	103	0,100	5.760	0,090	1040	90
6,0	20	0,378	6.500	0,146	1900	123	0,294	6.200	0,129	1600	117	0,210	5.500	0,121	1330	104
6,0	30	0,378	6.500	0,146	1900	123	0,294	6.200	0,129	1600	117	0,210	5.500	0,121	1330	104
8,0	25	0,504	4.850	0,186	1800	122	0,392	4.600	0,163	1500	116	0,280	4.000	0,160	1280	101
8,0	35	0,504	4.850	0,186	1800	122	0,392	4.600	0,163	1500	116	0,280	4.000	0,160	1280	101
10,0	30	0,900	3.850	0,214	1650	121	0,700	3.680	0,190	1400	116	0,500	3.200	0,188	1200	101
10,0	40	0,630	3.850	0,214	1650	121	0,490	3.680	0,190	1400	116	0,350	3.200	0,188	1200	101
12,0	32	1,080	3.200	0,238	1520	121	0,840	3.050	0,213	1300	115	0,600	2.650	0,208	1100	100

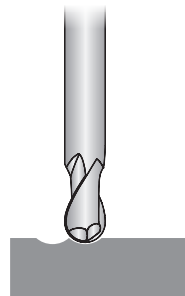

Schnitttiefe in einem Durchgang
Depth of cut in one pass

Die Tabellenwerte sind Richtwerte. Es kann notwendig sein, die Werte den jeweiligen Bearbeitungsumständen anzupassen.
The recommended cutting data are only approximate values. It may be necessary to adjust them to each individual machining application.

AFX

MATERIAL	Unlegierter Stahl / Non-alloyed steel				Legierter Stahl / Alloy steel				Gehärteter Stahl / Hardened steel			
	Legierter Stahl / Alloy steel				Hochwarmfester Stahl / Heat resistant steel							
	Gusseisen / Cast iron											
Härte / Hardness Zugfestigkeit / Strength	~ HRC 35 ~ 1100 N/mm ²				HRC 35 ~ HRC 45 1110 ~ 1500 N/mm ²				HRC 45 ~ HRC 55 1500 ~ 2000 N/mm ²			
d (mm)	n (U/min)	f _z (mm)	v _f (mm/min)	v _c (m/min)	n (U/min)	f _z (mm)	v _f (mm/min)	v _c (m/min)	n (U/min)	f _z (mm)	v _f (mm/min)	v _c (m/min)
1,0	26.800	0,002	250	84	16.080	0,002	150	51	10.720	0,001	47	34
1,2	22.500	0,003	265	85	13.500	0,003	160	51	9.000	0,001	47	34
1,5	18.750	0,004	270	88	11.250	0,004	165	53	7.500	0,002	47	35
2,0	14.450	0,005	295	91	9.450	0,005	180	59	6.300	0,002	53	40
2,5	12.800	0,006	315	101	8.200	0,006	195	64	5.250	0,003	58	41
3,0	11.150	0,008	335	105	6.950	0,008	210	66	4.200	0,004	63	40
3,5	10.300	0,011	465	113	6.360	0,011	290	70	3.940	0,004	63	43
4,0	9.450	0,016	600	119	5.780	0,016	370	73	3.680	0,004	63	46
4,5	8.660	0,018	615	122	5.250	0,018	375	74	3.290	0,005	70	47
5,0	7.880	0,020	630	124	4.730	0,020	380	74	2.900	0,006	75	46
5,5	7.410	0,022	660	128	4.460	0,023	405	77	2.700	0,007	80	47
6,0	6.950	0,025	695	131	4.200	0,026	430	79	2.500	0,009	85	47
6,5	6.530	0,027	710	133	3.940	0,027	425	80	2.400	0,010	95	49
7,0	6.100	0,030	720	134	3.680	0,028	415	81	2.300	0,011	100	51
7,5	5.680	0,032	735	134	3.410	0,030	410	80	2.200	0,013	110	52
8,0	5.250	0,035	745	132	3.150	0,032	400	79	2.100	0,014	115	53
8,5	4.960	0,036	720	132	2.990	0,032	380	80	2.000	0,014	110	53
9,0	4.660	0,037	695	132	2.830	0,031	355	80	1.900	0,014	105	54
9,5	4.370	0,038	665	130	2.660	0,031	335	79	1.800	0,014	100	54
10,0	4.080	0,039	640	128	2.500	0,032	315	79	1.700	0,014	95	53
10,5	3.910	0,040	620	129	2.400	0,032	305	79	1.640	0,014	95	54
11,0	3.750	0,040	595	130	2.300	0,032	290	79	1.580	0,014	90	55
11,5	3.590	0,040	570	130	2.200	0,032	280	79	1.510	0,015	90	50
12,0	3.430	0,040	545	129	2.100	0,032	265	79	1.450	0,015	85	55
13,0	3.260	0,040	520	133	2.000	0,031	250	82	1.370	0,015	80	56
14,0	3.090	0,040	490	136	1.900	0,031	235	84	1.290	0,015	75	57
16,0	2.750	0,040	440	138	1.700	0,032	215	85	1.130	0,014	65	57
18,0	2.430	0,040	385	137	1.510	0,031	190	85	990	0,014	55	56
20,0	2.100	0,040	335	132	1.330	0,032	170	84	850	0,012	42	53
25,0	1.700	0,039	265	134	1.050	0,032	135	82	680	0,012	32	53

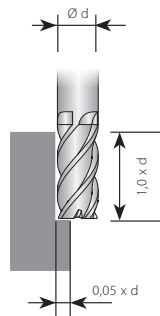

Die Tabellenwerte sind Richtwerte. Es kann notwendig sein, die Werte den jeweiligen Bearbeitungsumständen anzupassen.
The recommended cutting data are only approximate values. It may be necessary to adjust them to each individual machining application.

Empfohlene Schnittwerte AFX50041-...

Ausführung AFX

Recommended cutting data AFX50041-...

Design AFX

MATERIAL		Unlegierter Stahl / Non-alloyed steel					Legierter Stahl / Alloy steel					Gehärteter Stahl / Hardened steel				
Härte / Hardness		Legierter Stahl / Alloy steel					Hochwarmfester Stahl / Heat resistant steel					Gehärteter Stahl / Hardened steel				
Zugfestigkeit / Strength		~ HRc 35					HRc 35 ~ HRc 45					HRc 45 ~ HRc 55				
		~ 1100 N/mm ²					1110 ~ 1500 N/mm ²					1500 ~ 2000 N/mm ²				
d	l ₂	a _e	n	f _z	v _f	v _c	a _e	n	f _z	v _f	v _c	a _e	n	f _z	v _f	v _c
(mm)	(mm)	(mm)	(U/min)	(mm)	(mm/min)	(m/min)	(mm)	(U/min)	(mm)	(mm/min)	(m/min)	(mm)	(U/min)	(mm)	(mm/min)	(m/min)
1,0	4	0,021	33.100	0,003	360	104	0,016	21.600	0,003	260	68	0,013	13.200	0,003	140	41
1,0	6	0,012	29.790	0,002	290	94	0,009	19.440	0,003	210	61	0,007	11.880	0,002	115	37
1,0	8	0,012	29.790	0,002	290	94	0,009	19.440	0,003	210	61	0,007	11.880	0,002	115	37
1,2	4	0,025	29.750	0,003	365	112	0,019	18.900	0,004	265	71	0,015	11.700	0,003	140	44
1,2	6	0,025	29.750	0,003	365	112	0,019	18.900	0,004	265	71	0,015	11.700	0,003	140	44
1,2	8	0,014	26.780	0,003	295	101	0,011	17.010	0,003	215	64	0,009	10.530	0,003	115	40
1,5	6	0,032	26.400	0,004	370	124	0,024	16.200	0,004	270	76	0,019	10.200	0,003	140	48
1,5	8	0,018	23.760	0,003	300	112	0,014	14.580	0,004	220	69	0,011	9.180	0,003	115	43
1,5	10	0,018	23.760	0,003	300	112	0,014	14.580	0,004	220	69	0,011	9.180	0,003	115	43
1,5	12	0,018	23.760	0,003	300	112	0,014	14.580	0,004	220	69	0,011	9.180	0,003	115	43
2,0	6	0,060	21.600	0,004	380	136	0,045	13.800	0,005	280	87	0,036	8.640	0,004	150	54
2,0	8	0,042	21.600	0,004	380	136	0,032	13.800	0,005	280	87	0,025	8.640	0,004	150	54
2,0	10	0,042	21.600	0,004	380	136	0,032	13.800	0,005	280	87	0,025	8.640	0,004	150	54
2,0	12	0,024	19.440	0,004	310	122	0,018	12.420	0,005	225	78	0,014	7.780	0,004	120	49
3,0	8	0,090	15.900	0,006	400	150	0,068	10.300	0,008	310	97	0,054	6.300	0,006	150	59
3,0	10	0,063	15.900	0,006	400	150	0,047	10.300	0,008	310	97	0,038	6.300	0,006	150	59
3,0	12	0,063	15.900	0,006	400	150	0,047	10.300	0,008	310	97	0,038	6.300	0,006	150	59
3,0	16	0,036	14.310	0,006	325	135	0,027	9.270	0,007	250	87	0,022	5.670	0,005	120	53
3,0	20	0,036	14.310	0,006	325	135	0,027	9.270	0,007	250	87	0,022	5.670	0,005	120	53
3,0	26	0,023	14.310	0,006	325	135	0,017	9.270	0,007	250	87	0,014	5.670	0,005	120	53
4,0	10	0,120	12.800	0,010	500	161	0,090	8.200	0,011	360	103	0,072	5.150	0,008	160	65
4,0	12	0,120	12.800	0,010	500	161	0,090	8.200	0,011	360	103	0,072	5.150	0,008	160	65
4,0	16	0,084	12.800	0,010	500	161	0,063	8.200	0,011	360	103	0,050	5.150	0,008	160	65
4,0	20	0,084	12.800	0,010	500	161	0,063	8.200	0,011	360	103	0,050	5.150	0,008	160	65
4,0	26	0,048	11.520	0,009	405	145	0,036	7.380	0,010	290	93	0,029	4.640	0,007	130	58
6,0	20	0,126	9.500	0,013	510	179	0,095	6.000	0,018	430	113	0,076	3.930	0,013	200	74
8,0	25	0,168	7.200	0,019	550	181	0,126	4.550	0,024	430	114	0,101	3.020	0,017	200	76
8,0	35	0,168	7.200	0,019	550	181	0,126	4.550	0,024	430	114	0,101	3.020	0,017	200	76
10,0	30	0,300	6.000	0,023	550	188	0,225	4.000	0,027	430	126	0,180	2.420	0,021	200	76
10,0	40	0,210	6.000	0,023	550	188	0,158	4.000	0,027	430	126	0,126	2.420	0,021	200	76
12,0	32	0,360	5.000	0,022	430	188	0,270	3.340	0,028	380	126	0,216	2.000	0,020	160	75
12,0	45	0,252	5.000	0,022	430	188	0,189	3.340	0,028	380	126	0,151	2.000	0,020	160	75
16,0	35	0,480	3.720	0,022	330	187	0,360	2.520	0,028	280	127	0,288	1.540	0,022	135	77
20,0	40	0,600	3.000	0,023	270	188	0,450	1.950	0,027	210	123	0,360	1.200	0,021	100	75

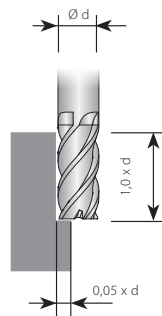

Die Tabellenwerte sind Richtwerte. Es kann notwendig sein, die Werte den jeweiligen Bearbeitungsumständen anzupassen.
The recommended cutting data are only approximate values. It may be necessary to adjust them to each individual machining application.

AFX

Empfohlene Schnittwerte AFX50741-...

Ausführung AFX

Recommended cutting data AFX50741-...

Design AFX

MATERIAL	Unlegierter Stahl / Non-alloyed steel				Legierter Stahl / Alloy steel				Gehärteter Stahl / Hardened steel			
	Legierter Stahl / Alloy steel				Hochwarmfester Stahl / Heat resistant steel							
	Gusseisen / Cast iron											
Härte / Hardness Zugfestigkeit / Strength	~ HRC 35 ~ 1100 N/mm ²				HRC 35 ~ HRC 45 1110 ~ 1500 N/mm ²				HRC 45 ~ HRC 55 1500 ~ 2000 N/mm ²			
d (mm)	n (U/min)	f _z (mm)	v _f (mm/min)	v _c (m/min)	n (U/min)	f _z (mm)	v _f (mm/min)	v _c (m/min)	n (U/min)	f _z (mm)	v _f (mm/min)	v _c (m/min)
1,0	27.600	0,003	300	87	18.000	0,003	220	57	11.000	0,003	120	35
1,5	22.000	0,004	310	104	13.500	0,004	230	64	8.500	0,004	120	40
2,0	18.000	0,004	320	113	11.560	0,005	240	73	7.200	0,005	130	45
2,5	15.000	0,006	330	118	9.500	0,007	250	75	6.100	0,005	130	48
3,0	13.240	0,006	340	125	8.560	0,008	260	81	5.280	0,006	130	50
4,0	10.720	0,010	420	135	6.820	0,011	300	86	4.300	0,008	140	54
5,0	9.160	0,012	430	144	5.800	0,016	360	91	3.800	0,011	170	60
6,0	7.900	0,014	430	149	5.040	0,018	360	95	3.280	0,013	170	62
8,0	6.000	0,019	460	151	3.800	0,024	360	96	2.520	0,017	170	63
10,0	5.040	0,023	460	158	3.280	0,027	360	103	2.020	0,021	170	63
12,0	4.120	0,022	360	155	2.780	0,029	320	105	1.680	0,021	140	63
16,0	3.100	0,023	280	156	2.100	0,027	230	106	1.280	0,022	115	64
20,0	2.520	0,023	230	158	1.640	0,027	180	103	1.000	0,023	90	63

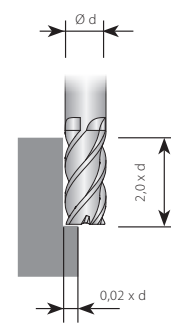
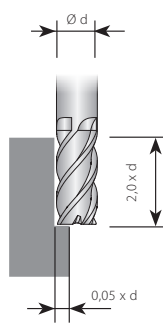

Die Tabellenwerte sind Richtwerte. Es kann notwendig sein, die Werte den jeweiligen Bearbeitungsumständen anzupassen.
The recommended cutting data are only approximate values. It may be necessary to adjust them to each individual machining application.



MATERIAL	Unlegierter Stahl / Non-alloyed steel				Legierter Stahl / Alloy steel				Gehärteter Stahl / Hardened steel				
	Legierter Stahl / Alloy steel Gusseisen / Cast iron				Hochwarmfester Stahl / Heat resistant steel								
	~ HRC 35 ~ 1100 N/mm ²				HRC 35 ~ HRC 45 1110 ~ 1500 N/mm ²				HRC 45 ~ HRC 55 1500 ~ 2000 N/mm ²				
Härte / Hardness Zugfestigkeit / Strength	d (mm)	n (U/min)	f _z (mm)	v _f (mm/min)	v _c (m/min)	n (U/min)	f _z (mm)	v _f (mm/min)	v _c (m/min)	n (U/min)	f _z (mm)	v _f (mm/min)	v _c (m/min)
1,0	26.800	0,002	250	84	16.080	0,002	150	51	10.720	0,001	47	34	
1,2	22.500	0,003	265	85	13.500	0,003	160	51	9.000	0,001	47	34	
1,5	18.750	0,004	270	88	11.250	0,004	165	53	7.500	0,002	47	35	
2,0	14.450	0,005	295	91	9.450	0,005	180	59	6.300	0,002	53	40	
2,5	12.800	0,006	315	101	8.200	0,006	195	64	5.250	0,003	58	41	
3,0	11.150	0,008	335	105	6.950	0,008	210	66	4.200	0,004	63	40	
3,5	10.300	0,011	465	113	6.360	0,011	290	70	3.940	0,004	63	43	
4,0	9.450	0,016	600	119	5.780	0,016	370	73	3.680	0,004	63	46	
4,5	8.660	0,018	615	122	5.250	0,018	375	74	3.290	0,005	70	47	
5,0	7.880	0,020	630	124	4.730	0,020	380	74	2.900	0,006	75	46	
5,5	7.410	0,022	660	128	4.460	0,023	405	77	2.700	0,007	80	47	
6,0	6.950	0,025	695	131	4.200	0,026	430	79	2.500	0,009	85	47	
6,5	6.530	0,027	710	133	3.940	0,027	425	80	2.400	0,010	95	49	
7,0	6.100	0,030	720	134	3.680	0,028	415	81	2.300	0,011	100	51	
7,5	5.680	0,032	735	134	3.410	0,030	410	80	2.200	0,013	110	52	
8,0	5.250	0,035	745	132	3.150	0,032	400	79	2.100	0,014	115	53	
8,5	4.960	0,036	720	132	2.990	0,032	380	80	2.000	0,014	110	53	
9,0	4.660	0,037	695	132	2.830	0,031	355	80	1.900	0,014	105	54	
9,5	4.370	0,038	665	130	2.660	0,031	335	79	1.800	0,014	100	54	
10,0	4.080	0,039	640	128	2.500	0,032	315	79	1.700	0,014	95	53	
10,5	3.910	0,040	620	129	2.400	0,032	305	79	1.640	0,014	95	54	
11,0	3.750	0,040	595	130	2.300	0,032	290	79	1.580	0,014	90	55	
11,5	3.590	0,040	570	130	2.200	0,032	280	79	1.510	0,015	90	50	
12,0	3.430	0,040	545	129	2.100	0,032	265	79	1.450	0,015	85	55	
13,0	3.260	0,040	520	133	2.000	0,031	250	82	1.370	0,015	80	56	
14,0	3.090	0,040	490	136	1.900	0,031	235	84	1.290	0,015	75	57	
16,0	2.750	0,040	440	138	1.700	0,032	215	85	1.130	0,014	65	57	
18,0	2.430	0,040	385	137	1.510	0,031	190	85	990	0,014	55	56	
20,0	2.100	0,040	335	132	1.330	0,032	170	84	850	0,012	42	53	
25,0	1.700	0,039	265	134	1.050	0,032	135	82	680	0,012	32	53	

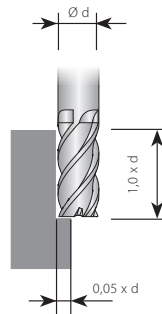

Die Tabellenwerte sind Richtwerte. Es kann notwendig sein, die Werte den jeweiligen Bearbeitungsumständen anzupassen.
The recommended cutting data are only approximate values. It may be necessary to adjust them to each individual machining application.

Empfohlene Schnittwerte AFX50141-...

Ausführung AFX

Recommended cutting data AFX50141-...

Design AFX

MATERIAL		Unlegierter Stahl / Non-alloyed steel					Legierter Stahl / Alloy steel					Gehärteter Stahl / Hardened steel				
		Legierter Stahl / Alloy steel					Hochwärmefester Stahl / Heat resistant steel									
Härte / Hardness		~ HRC 35					HRC 35 ~ HRC 45					HRC 45 ~ HRC 55				
Zugfestigkeit / Strength		~ 1100 N/mm ²					1110 ~ 1500 N/mm ²					1500 ~ 2000 N/mm ²				
d	l ₁	n	f _z	v _f	v _c	n	f _z	v _f	v _c	n	f _z	v _f	v _c			
(mm)	(mm)	(U/min)	(mm)	(mm/min)	(m/min)	(U/min)	(mm)	(mm/min)	(m/min)	(U/min)	(mm)	(mm/min)	(m/min)			
1,0	3	19.200	0,002	180	60	10.940	0,002	70	34	6.720	0,001	35	21			
1,0	4	19.200	0,002	180	60	10.940	0,002	70	34	6.720	0,001	35	21			
1,0	5	19.200	0,002	180	60	10.940	0,002	70	34	6.720	0,001	35	21			
1,0	6	17.280	0,002	145	54	9.850	0,002	60	31	6.050	0,001	30	19			
1,5	6	13.800	0,004	215	65	7.870	0,003	85	37	4.830	0,002	45	23			
2,0	8	10.580	0,006	240	66	6.050	0,004	95	38	3.780	0,004	55	24			
2,0	10	10.580	0,006	240	66	6.050	0,004	95	38	3.780	0,004	55	24			
2,0	12	9.530	0,005	195	60	5.440	0,004	80	34	3.400	0,003	45	21			
2,0	14	9.530	0,005	195	60	5.440	0,004	80	34	3.400	0,003	45	21			
2,5	10	8.990	0,007	260	71	5.170	0,005	110	41	3.210	0,005	60	25			
2,5	12	8.990	0,007	260	71	5.170	0,005	110	41	3.210	0,005	60	25			
3,0	10	7.400	0,009	275	70	4.280	0,007	120	40	2.640	0,006	65	25			
3,0	12	7.400	0,009	275	70	4.280	0,007	120	40	2.640	0,006	65	25			
3,0	16	6.660	0,009	250	63	3.860	0,007	110	36	2.380	0,006	60	22			
3,0	20	6.660	0,008	225	63	3.860	0,006	95	36	2.380	0,006	55	22			
3,0	26	6.660	0,008	200	63	3.860	0,006	85	36	2.380	0,005	50	22			
3,0	30	6.660	0,008	200	63	3.860	0,006	85	36	2.380	0,005	50	22			
4,0	12	6.000	0,014	335	75	3.410	0,010	140	43	2.150	0,008	70	27			
4,0	16	6.000	0,014	335	75	3.410	0,010	140	43	2.150	0,008	70	27			
4,0	20	6.000	0,014	335	75	3.410	0,010	140	43	2.150	0,008	70	27			
4,0	26	5.400	0,013	270	68	3.070	0,009	110	39	1.930	0,008	60	24			
4,0	30	5.400	0,013	270	68	3.070	0,009	110	39	1.930	0,008	60	24			
5,0	20	5.120	0,021	430	80	2.900	0,015	170	46	1.900	0,011	85	30			
5,0	25	5.120	0,021	430	80	2.900	0,015	170	46	1.900	0,011	85	30			
5,0	30	4.610	0,019	350	72	2.610	0,013	135	41	1.710	0,010	70	27			
6,0	15	4.420	0,029	515	83	2.520	0,021	215	48	1.640	0,017	110	31			
6,0	20	4.420	0,029	515	83	2.520	0,021	215	48	1.640	0,017	110	31			
6,0	25	4.420	0,029	515	83	2.520	0,021	215	48	1.640	0,017	110	31			
6,0	30	4.420	0,025	440	83	2.520	0,018	185	48	1.640	0,014	90	31			
6,0	35	3.970	0,025	395	75	2.270	0,018	165	43	1.480	0,014	85	28			
6,0	40	3.970	0,022	350	75	2.270	0,016	145	43	1.480	0,013	75	28			
6,0	45	3.970	0,022	350	75	2.270	0,016	145	43	1.480	0,013	75	28			
8,0	25	3.360	0,041	550	84	1.900	0,028	215	48	1.260	0,022	110	32			
8,0	30	3.360	0,041	550	84	1.900	0,028	215	48	1.260	0,022	110	32			
8,0	35	3.360	0,041	550	84	1.900	0,028	215	48	1.260	0,022	110	32			
8,0	40	3.360	0,035	470	84	1.900	0,024	185	48	1.260	0,018	90	32			
8,0	45	3.020	0,035	420	76	1.710	0,024	165	43	1.130	0,019	85	28			
8,0	50	3.020	0,031	375	76	1.710	0,021	145	43	1.130	0,017	75	28			
10,0	30	2.820	0,049	550	59	1.640	0,033	215	52	1.010	0,027	110	32			
10,0	35	2.820	0,049	550	59	1.640	0,033	215	52	1.010	0,027	110	32			
10,0	40	2.820	0,049	550	59	1.640	0,033	215	52	1.010	0,027	110	32			
10,0	45	2.820	0,042	470	89	1.640	0,028	185	52	1.010	0,022	90	32			
10,0	50	2.820	0,042	470	89	1.640	0,028	185	52	1.010	0,022	90	32			
12,0	35	2.300	0,047	430	87	1.390	0,034	190	52	840	0,025	85	32			
12,0	40	2.300	0,047	430	87	1.390	0,034	190	52	840	0,025	85	32			
12,0	45	2.300	0,040	365	87	1.390	0,030	165	52	840	0,021	70	32			
12,0	50	2.300	0,040	365	87	1.390	0,030	165	52	840	0,021	70	32			
12,0	55	2.300	0,040	365	87	1.390	0,030	165	52	840	0,021	70	32			
12,0	60	2.300	0,035	325	87	1.390	0,026	145	52	840	0,019	65	32			
14,0	50	2.120	0,041	345	93	1.230	0,029	145	54	760	0,021	68	33			
16,0	50	1.940	0,050	385	98	1.070	0,035	150	54	670	0,026	70	34			
16,0	60	1.940	0,042	325	98	1.070	0,030	130	54	670	0,022	60	34			
16,0	70	1.940	0,042	325	98	1.070	0,030	130	54	670	0,022	60	34			
18,0	50	1.680	0,049	330	95	940	0,035	130	53	590	0,028	65	33			
20,0	60	1.420	0,048	275	89	820	0,034	110	52	500	0,028	55	31			
20,0	90	1.420	0,036	205	89	820	0,024	80	52	500	0,020	40	31			
25,0	90	1.100	0,042	185	86	820	0,027	90	64	500	0,023	45	39			

AFX



Die Tabellenwerte sind Richtwerte. Es kann notwendig sein, die Werte den jeweiligen Bearbeitungsumständen anzupassen.
The recommended cutting data are only approximate values. It may be necessary to adjust them to each individual machining application.

Empfohlene Schnittwerte AFX50142-...

Ausführung AFX

Recommended cutting data AFX50142-...

Design AFX

MATERIAL		Unlegierter Stahl / Non-alloyed steel Legierter Stahl / Alloy steel Gusseisen / Cast iron						Legierter Stahl / Alloy steel Hochwarmfester Stahl / Heat resistant steel					Gehärteter Stahl / Hardened steel			
Härte / Hardness Zugfestigkeit / Strength		~ HRc 35 ~ 1100 N/mm ²						HRc 35 ~ HRc 45 1110 ~ 1500 N/mm ²					HRc 45 ~ HRc 55 1500 ~ 2000 N/mm ²			
d	l ₂	a _e	n	f _z	v _f	v _c	a _e	n	f _z	v _f	v _c	a _e	n	f _z	v _f	v _c
(mm)	(mm)	(mm)	(U/min)	(mm)	(mm/min)	(m/min)	(mm)	(U/min)	(mm)	(mm/min)	(m/min)	(mm)	(U/min)	(mm)	(mm/min)	(m/min)
1,0	4	0,015	22.000	0,004	310	69	0,011	13.500	0,003	180	42	0,009	8.500	0,001	50	27
1,0	5	0,015	22.000	0,004	310	69	0,011	13.500	0,003	180	42	0,009	8.500	0,001	50	27
1,0	6	0,008	19.800	0,003	250	62	0,006	12.150	0,003	145	38	0,005	7.650	0,001	40	24
1,0	8	0,008	19.800	0,003	250	62	0,006	12.150	0,003	145	38	0,005	7.650	0,001	40	24
1,5	6	0,022	17.000	0,005	320	80	0,017	10.700	0,004	190	50	0,013	6.500	0,002	50	31
1,5	8	0,013	15.300	0,004	260	72	0,009	9.630	0,004	155	45	0,008	5.850	0,002	40	28
1,5	10	0,013	15.300	0,004	260	72	0,009	9.630	0,004	155	45	0,008	5.850	0,002	40	28
1,5	12	0,013	15.300	0,004	260	72	0,009	9.630	0,004	155	45	0,008	5.850	0,002	40	28
1,5	16	0,008	13.600	0,004	205	64	0,006	8.560	0,004	120	40	0,005	5.200	0,001	30	25
2,0	8	0,029	13.900	0,006	330	87	0,022	9.070	0,006	200	57	0,018	6.000	0,003	60	38
2,0	10	0,029	13.900	0,006	330	87	0,022	9.070	0,006	200	57	0,018	6.000	0,003	60	38
2,0	12	0,017	12.510	0,005	265	79	0,013	8.160	0,005	160	51	0,010	5.400	0,002	50	34
2,0	16	0,017	12.510	0,005	265	79	0,013	8.160	0,005	160	51	0,010	5.400	0,002	50	34
3,0	10	0,044	10.700	0,009	380	101	0,033	6.670	0,009	240	63	0,026	4.030	0,004	70	38
3,0	12	0,044	10.700	0,009	380	101	0,033	6.670	0,009	240	63	0,026	4.030	0,004	70	38
3,0	16	0,025	9.630	0,008	310	91	0,019	6.000	0,008	195	57	0,015	3.630	0,004	55	34
3,0	20	0,025	9.630	0,008	310	91	0,019	6.000	0,008	195	57	0,015	3.630	0,004	55	34
3,0	30	0,016	9.630	0,008	310	91	0,012	6.000	0,008	198	57	0,009	3.630	0,004	55	34
4,0	12	0,084	9.070	0,019	680	114	0,063	5.540	0,019	420	70	0,050	3.530	0,005	70	44
4,0	16	0,059	9.070	0,019	680	114	0,044	5.540	0,019	420	70	0,035	3.530	0,005	70	44
4,0	20	0,059	9.070	0,019	680	114	0,044	5.540	0,019	420	70	0,035	3.530	0,005	70	44
4,0	30	0,034	8.160	0,017	550	103	0,025	4.990	0,017	340	63	0,020	3.180	0,004	55	40
4,0	40	0,021	8.160	0,017	550	103	0,016	4.990	0,017	340	63	0,013	3.180	0,004	55	40
5,0	20	0,074	7.560	0,024	720	119	0,055	5.430	0,024	430	71	0,044	2.780	0,008	85	44
5,0	40	0,042	6.800	0,022	585	107	0,032	4.080	0,021	350	64	0,025	2.500	0,007	70	39
6,0	15	0,126	6.670	0,030	790	126	0,095	4.030	0,030	490	76	0,076	2.400	0,010	95	45
6,0	30	0,088	6.670	0,030	790	126	0,066	4.030	0,030	490	76	0,053	2.400	0,010	95	45
8,0	25	0,118	5.040	0,042	850	127	0,088	3.020	0,037	450	76	0,071	2.010	0,016	130	51
8,0	42	0,067	4.540	0,038	690	114	0,050	2.720	0,034	365	68	0,040	1.810	0,015	105	45
10,0	30	0,210	3.910	0,047	730	123	0,158	2.400	0,038	360	75	0,126	1.630	0,016	105	51
10,0	45	0,147	3.910	0,047	730	123	0,110	2.400	0,038	360	75	0,088	1.630	0,016	105	51
12,0	35	0,252	3.300	0,047	620	124	0,189	2.010	0,037	300	76	0,151	1.400	0,017	95	53
12,0	50	0,176	3.300	0,047	620	124	0,132	2.010	0,037	300	76	0,106	1.400	0,017	95	53

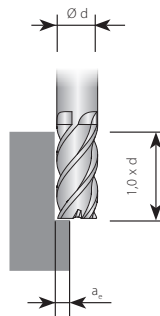

Die Tabellenwerte sind Richtwerte. Es kann notwendig sein, die Werte den jeweiligen Bearbeitungsumständen anzupassen.
The recommended cutting data are only approximate values. It may be necessary to adjust them to each individual machining application.

AFX

Normale Geschwindigkeit

Normal speed

MATERIAL		Unlegierter Stahl / Non-alloyed steel				Legierter Stahl / Alloy steel				Gehärteter Stahl / Hardened steel			
		Legierter Stahl / Alloy steel				Hochwarmfester Stahl / Heat resistant steel							
Härte / Hardness		~ HRc 35				HRc 35 ~ HRc 45				HRc 45 ~ HRc 55			
Zugfestigkeit / Strength		~ 1100 N/mm ²				1110 ~ 1500 N/mm ²				1500 ~ 2000 N/mm ²			
d ₁	l ₁	n	f _z	v _f	v _c	n	f _z	v _f	v _c	n	f _z	v _f	v _c
(mm)	(mm)	(U/min)	(mm)	(mm/min)	(m/min)	(U/min)	(mm)	(mm/min)	(m/min)	(U/min)	(mm)	(mm/min)	(m/min)
6,0	15	5.840	0,060	2.100	110	4.075	0,059	1.440	77	1.660	0,022	220	31
6,0	30	5.840	0,051	1.785	110	4.075	0,050	1.225	77	1.660	0,019	190	31
8,0	20	4.410	0,079	2.100	111	3.085	0,078	1.440	78	1.220	0,030	220	31
8,0	40	4.410	0,067	1.785	111	3.085	0,066	1.225	78	1.220	0,026	190	31
10,0	25	3.530	0,099	2.100	111	2.435	0,099	1.440	76	1.050	0,035	220	33
10,0	40	3.530	0,099	2.100	111	2.435	0,099	1.440	76	1.050	0,035	220	33
12,0	30	2.980	0,099	1.765	112	2.100	0,097	1.220	79	880	0,036	190	33
12,0	50	2.980	0,084	1.500	112	2.100	0,082	1.035	79	880	0,031	165	33
12,0	60	2.980	0,074	1.325	112	2.100	0,073	915	79	880	0,027	140	33
16,0	40	2.205	0,100	1.325	111	1.555	0,099	925	78	670	0,034	135	34
16,0	60	2.205	0,085	1.125	111	1.555	0,085	790	78	670	0,029	115	34
20,0	45	1.765	0,100	1.060	111	1.220	0,099	725	77	525	0,037	115	33
20,0	60	1.765	0,100	1.060	111	1.220	0,099	725	77	525	0,037	115	33

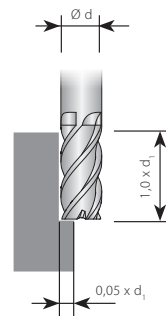
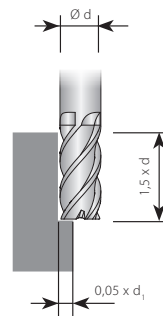
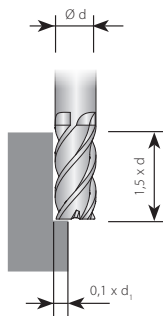

Hochgeschwindigkeitsfräsen HFC

High speed

MATERIAL		Legierter Stahl / Alloy steel				Gehärteter Stahl / Hardened steel			
		Hochwarmfester Stahl / Heat resistant steel							
Härte / Hardness		HRc 35 ~ HRc 45				HRc 45 ~ HRc 55			
Zugfestigkeit / Strength		1110 ~ 1500 N/mm ²				1500 ~ 2000 N/mm ²			
d ₁	l ₁	n	f _z	v _f	v _c	n	f _z	v _f	v _c
(mm)	(mm)	(U/min)	(mm)	(mm/min)	(m/min)	(U/min)	(mm)	(mm/min)	(m/min)
6,0	15	17.640	0,060	6.395	333	8.820	0,061	3.205	166
6,0	30	17.640	0,051	5.435	333	8.820	0,051	2.720	166
8,0	20	13.230	0,081	6.395	333	6.615	0,081	3.205	166
8,0	40	13.230	0,068	5.435	333	6.615	0,069	2.725	166
10,0	25	10.480	0,100	6.290	329	5.290	0,101	3.205	166
10,0	40	10.480	0,100	6.290	329	5.290	0,101	3.205	166
12,0	30	8.820	0,100	5.290	333	4.410	0,100	2.645	166
12,0	50	8.820	0,085	4.500	333	4.410	0,085	2.245	166
12,0	60	8.820	0,075	3.970	333	4.410	0,075	1.985	166
16,0	40	6.615	0,100	3.970	333	3.320	0,100	1.985	167
16,0	60	6.615	0,085	3.375	333	3.320	0,085	1.685	137
20,0	45	5.290	0,101	3.205	332	2.645	0,097	1.545	166
20,0	60	5.290	0,101	3.205	332	2.645	0,097	1.545	166

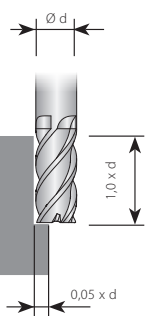
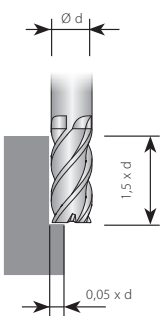

Die Tabellenwerte sind Richtwerte. Es kann notwendig sein, die Werte den jeweiligen Bearbeitungsumständen anzupassen.
The recommended cutting data are only approximate values. It may be necessary to adjust them to each individual machining application.

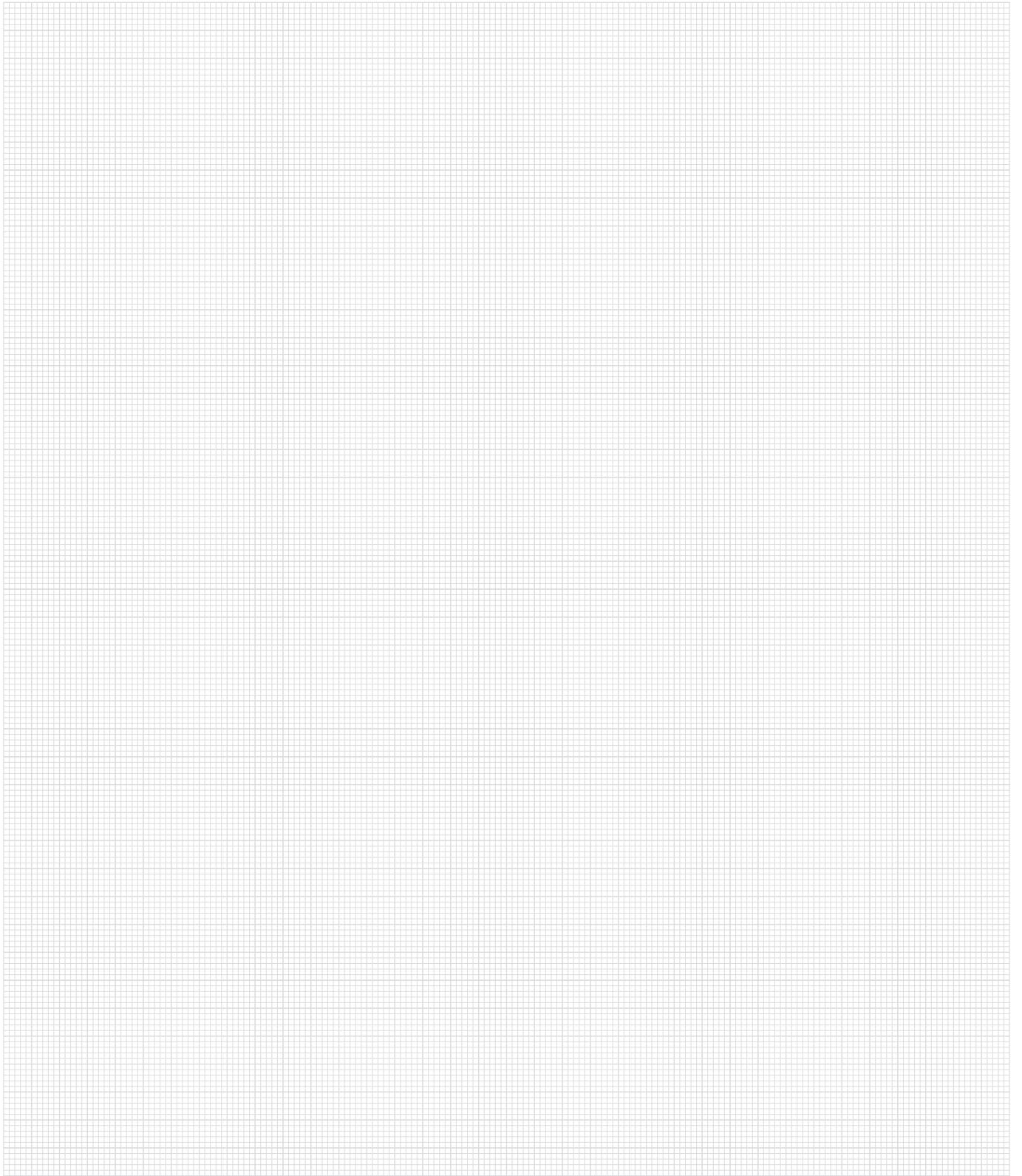

ARNO[®]
WERKZEUGE

Weitere Informationen finden Sie unter:
For more information see:

www.arno.de

ARNO[®]

WERKZEUGE

We have a passion for precision.

PM-HSS-FRÄSER

PM and HSS milling cutters

Ausführung

FP - für Stahl, rostfreien Stahl und Gusswerkstoffe

FS - für Stahl, rostfreien Stahl und Gusswerkstoffe









Design

FP - for steel, stainless steel and cast materials

FS - for steel, stainless steel and cast materials



Bezeichnung Description	Schneiden Flutes	Fräser Type	Ausführung Design	Spiralwinkel Helix angle	Abb. Picture	Seite Page
FP - Universalfräser für Stahl, rostfreien Stahl, Gusswerkstoffe / Universal cutter for steel, stainless steel and cast materials						
FP60120-...	2	PM-HSS Schaftfräser PM-HSS end-mill	kurz short	30°		312
FP60121-...	2	PM-HSS Schaftfräser PM-HSS end mill	lang long	30°		313
FP60320-...	2	PM-HSS-Radiusfräser PM-HSS ball-nose end-mill	kurz short	30°		314
FP60321-...	2	PM-HSS-Radiusfräser PM-HSS ball-nose end-mill	lang long	30°		315
FP60135-...	3	PM-HSS Schaftfräser PM-HSS end-mill	extra kurz extra short	30°		316
FP60130-...	3	PM-HSS Schaftfräser PM-HSS end-mill	kurz short	30°		317
FP601.0-...	4 - 6	PM-HSS Schaftfräser PM-HSS end-mill	kurz short	30°		318
FP601.1-...	4 - 6	PM-HSS Schaftfräser PM-HSS end-mill	lang long	30°		319
FP618.0-...	3 - 6	PM-HSS Schruppfräser PM-HSS roughing end-mill	kurz short	30°		320
FP618.6-...	3 - 6	PM-HSS Schruppfräser PM-HSS roughing end-mill	mittellang mid-length	30°		321
FP618.1-...	3 - 6	PM-HSS Schruppfräser PM-HSS roughing end-mill	lang long	30°		322

Bezeichnung Description	Schneiden Flutes	Fräser Type	Ausführung Design	Spiralwinkel Helix angle	Abb. Picture	Seite Page
FP - Universalfräser für Stahl, rostfreien Stahl, Gusswerkstoffe / Universal cutter for steel, stainless steel and cast materials						
FP619.5-...	4 - 6	PM-HSS Schruppfräser PM-HSS roughing end-mill	extra kurz extra short	45°		323
FP619.0-...	3 - 6	PM-HSS Schruppfräser PM-HSS roughing end-mill	kurz short	45°		324
FP620.0-...	3 - 6	PM-HSS Schruppfräser PM-HSS roughing end-mill	kurz short	30°		325
FP620.1-...	3 - 6	PM-HSS Schruppfräser PM-HSS roughing end-mill	lang long	30°		326
FP623.1-... / FP618.1-...	NEU NEW 4 - 5	PM-HSS Schruppfräser PM-HSS roughing end-mill	extra lang extra long	30°		327
FS - Universalfräser für Stahl, rostfreien Stahl, Gusswerkstoffe / Universal cutter for steel, stainless steel and cast materials						
FS60120-...	2	HSS Schaftfräser HSS end-mill	kurz short	30°		330
FS60320-...	2	HSS-Radiusfräser HSS ball-nose end-mill	kurz short	30°		331
FS60140-...	4	HSS Schaftfräser HSS end-mill	kurz short	30°		332
FS618.0-...	3 - 4	HSS-Schruppfräser HSS roughing end-mill	kurz short	30°		333
FS620.0-...	3 - 4	HSS-Schruppfräser HSS roughing end-mill	kurz short	30°		334

Weitere Highlights unserer Frässysteme.

Other highlights from our milling range.

ARNO®-Frässystem DUO-MILL

Eckfräsen und HFC-Fräsen mit nur einem Werkzeug.



ARNO® milling-system DUO-MILL

Square shoulder and high feed (HFC) milling with just one tool.

ARNO®-Frässystem FTA

Der universelle Planfräser zur Kostenreduzierung.



ARNO® milling-system FTA

Face milling tool for cost reduction.

ARNO®-Frässystem FOA

Der positiv weichschneidende Planfräser, der eine Rundplatte und eine oktagonale Wendschneidplatte in einem Plattensitz vereint.



ARNO® milling-system FOA

The positive face-milling-cutter, in which both a round and an octagonal insert can be used.

Informationen zu diesen Produkten finden Sie unter www.arno.de oder direkt bei ARNO®.

For more information on these products please see our website www.arno.de or contact ARNO®.

ARNO®
WERKZEUGE

Weitere Informationen finden Sie unter:
For more information see:

www.arno.de

ARNO[®]

WERKZEUGE

We have a passion for precision.

AUSFÜHRUNG FP

Design FP

Maximale Schnittleistung und minimaler Verschleiß bei der Bearbeitung von Stahl, rostfreiem Stahl, exotischen Materialien und Gusswerkstoffen.

Great performance and minimal wear for machining steel, stainless steel, exotics and cast materials.

Die TiAlN beschichteten Universalfräser aus pulvermetallurgischem HSS Schneidstoff sind extrem robust, zäh und verschleißfest. Dadurch ergeben sich deutlich verbesserte Standzeiten.



These universal powder metal cutters with their TiAlN coating are extremely strong, tough and wear resistant, therefore achieving excellent tool life.

PM-HSS-Schaftfräser

2 Schneiden, kurze Ausführung



PM-HSS end-mill

2 flutes, short design

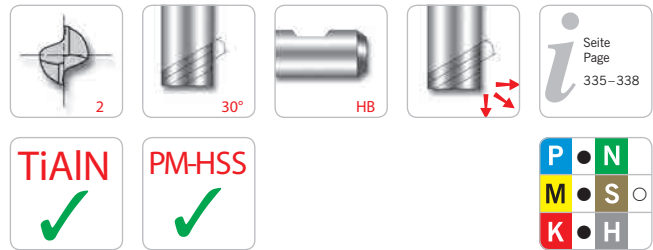

FP60120-...

Schaft / Shank DIN 6535HB	d e8	d _A h6	l ₁	l
FP60120-020	2,0	6	4	48
FP60120-030	3,0	6	5	49
FP60120-040	4,0	6	7	51
FP60120-050	5,0	6	8	52
FP60120-060	6,0	6	8	52
FP60120-070	7,0	10	10	60
FP60120-080	8,0	10	11	61
FP60120-090	9,0	10	11	61
FP60120-100	10,0	10	13	63
FP60120-120	12,0	12	16	73
FP60120-140	14,0	12	16	73
FP60120-160	16,0	16	19	79
FP60120-180	18,0	16	19	79
FP60120-200	20,0	20	22	88
FP60120-220	22,0	20	22	88
FP60120-250	25,0	25	26	102

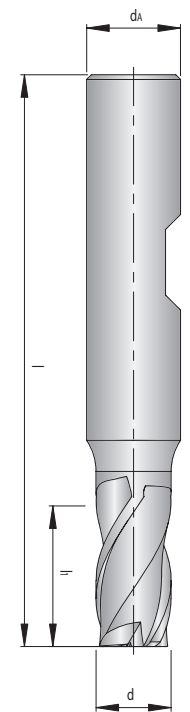

Toleranz / Tolerance (μm)	Nennwertbereich / Diameter range (mm)				
	≥ 1 - 3	> 3 - 6	> 6 - 10	> 10 - 18	> 18 - 30
e8	-14 -28	-20 -38	-25 -47	-32 -59	-40 -73
h6	0 -6	0 -8	0 -9	0 -11	0 -13

FP

● = Hauptanwendung / Main application
○ = Nebenanwendung / Suitable

Alle Angaben in mm / Dimensions in mm

PM-HSS-Schaftfräser

2 Schneiden, lange Ausführung



PM-HSS end-mill

2 flutes, long design

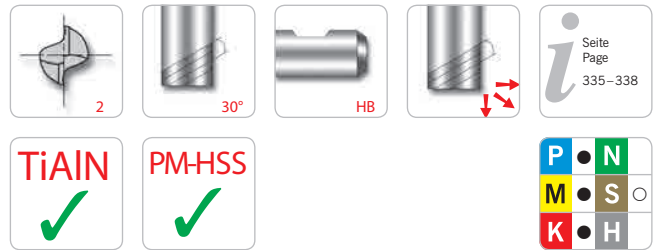

FP60121-...

Schaft / Shank DIN 6535HB	d e8	d _A h6	l ₁	l
FP60121-020	2,0	6	7	51
FP60121-030	3,0	6	8	52
FP60121-040	4,0	6	11	55
FP60121-050	5,0	6	13	57
FP60121-060	6,0	6	13	57
FP60121-070	7,0	10	16	66
FP60121-080	8,0	10	19	69
FP60121-090	9,0	10	19	69
FP60121-100	10,0	10	22	72
FP60121-120	12,0	12	26	83
FP60121-140	14,0	12	26	83
FP60121-160	16,0	16	32	92
FP60121-180	18,0	16	32	92
FP60121-200	20,0	20	38	104
FP60121-220	22,0	20	38	104
FP60121-250	25,0	25	45	121

Toleranz / Tolerance (μm)	Nennwertbereich / Diameter range (mm)				
	≥ 1 -3	>3 -6	>6 -10	>10 -18	>18 -30
e8	-14 -28	-20 -38	-25 -47	-32 -59	-40 -73
h6	0 -6	0 -8	0 -9	0 -11	0 -13

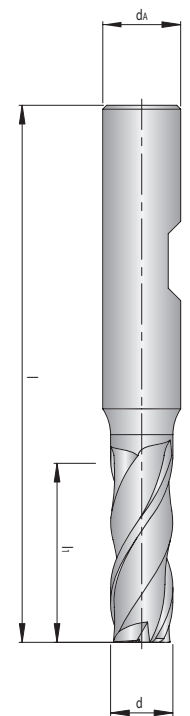

FP

● = Hauptanwendung / Main application
○ = Nebenanwendung / Suitable

Alle Angaben in mm / Dimensions in mm

PM-HSS-Radiusfräser

2 Schneiden, kurze Ausführung



PM-HSS ball-nose end-mill

2 flutes, short design

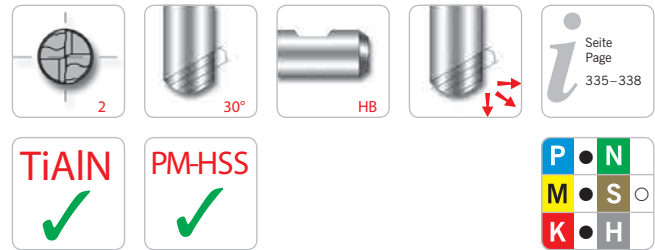

FP60320-...

Schaft / Shank DIN 6535HB	d	d _A	l ₁	l	R
FP60320-020	2,0	6	4	48	1,00
FP60320-030	3,0	6	5	49	1,50
FP60320-040	4,0	6	7	51	2,00
FP60320-050	5,0	6	8	52	2,50
FP60320-060	6,0	6	8	52	3,00
FP60320-070	7,0	10	10	60	3,50
FP60320-080	8,0	10	11	61	4,00
FP60320-090	9,0	10	11	61	4,50
FP60320-100	10,0	10	13	63	5,00
FP60320-120	12,0	12	16	73	6,00
FP60320-140	14,0	12	16	73	7,00
FP60320-160	16,0	16	19	79	8,00
FP60320-180	18,0	16	19	79	9,00
FP60320-200	20,0	20	22	88	10,00
FP60320-220	22,0	20	22	88	11,00
FP60320-250	25,0	25	26	102	12,50

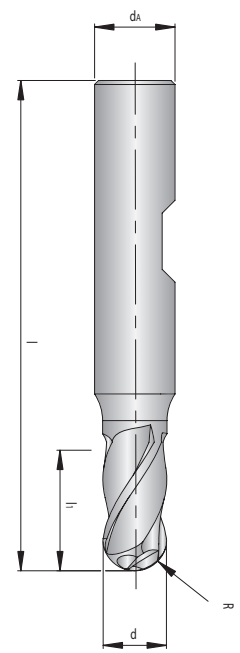

Toleranz / Tolerance	
Fräser / Mill	0 -0,03
Radius / Radius	±0,02
Schaft / Shank	h6

FP

● = Hauptanwendung / Main application
○ = Nebenanwendung / Suitable

Alle Angaben in mm / Dimensions in mm

PM-HSS-Radiusfräser

2 Schneiden, lange Ausführung



PM-HSS ball-nose end-mill

2 flutes, long design

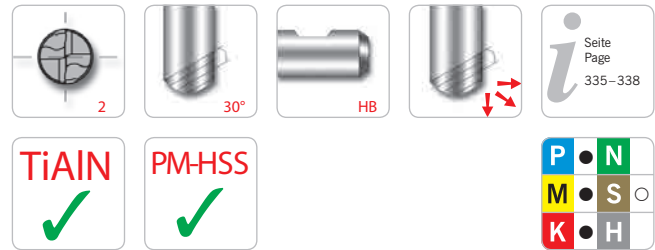

FP60321-....

Schaft / Shank DIN 6535HB	d	d _A	l ₁	l	R
FP60321-030	3,0	6	8	56	1,50
FP60321-040	4,0	6	11	63	2,00
FP60321-050	5,0	6	13	68	2,50
FP60321-060	6,0	6	13	68	3,00
FP60321-070	7,0	10	16	80	3,50
FP60321-080	8,0	10	19	88	4,00
FP60321-090	9,0	10	19	88	4,50
FP60321-100	10,0	10	22	95	5,00
FP60321-120	12,0	12	26	110	6,00
FP60321-140	14,0	12	26	110	7,00
FP60321-160	16,0	16	32	123	8,00
FP60321-180	18,0	16	32	123	9,00
FP60321-200	20,0	20	38	141	10,00
FP60321-220	22,0	20	38	141	11,00
FP60321-250	25,0	25	45	166	12,50

Toleranz / Tolerance	
Fräser / Mill	⁰ -0,03
Radius / Radius	±0,02
Schaft / Shank	h6

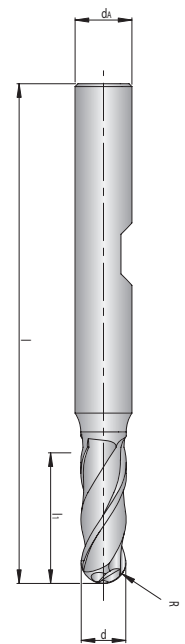

FP

● = Hauptanwendung / Main application
○ = Nebenanwendung / Suitable

Alle Angaben in mm / Dimensions in mm

PM-HSS-Schaftfräser

3 Schneiden, extra kurze Ausführung



PM-HSS end-mill

3 flutes, extra short design

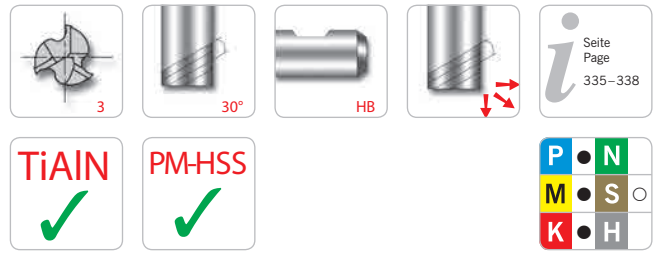

FP60135-...

Schaft / Shank DIN 6535HB	d e8	d _A h6	l ₁	l
FP60135-020	2,0	6	4	48
FP60135-030	3,0	6	5	49
FP60135-040	4,0	6	7	51
FP60135-050	5,0	6	8	52
FP60135-060	6,0	6	8	52
FP60135-070	7,0	10	10	60
FP60135-080	8,0	10	11	61
FP60135-090	9,0	10	11	61
FP60135-100	10,0	10	13	63
FP60135-120	12,0	12	16	73
FP60135-140	14,0	12	16	73
FP60135-160	16,0	16	19	79
FP60135-180	18,0	16	19	79
FP60135-200	20,0	20	22	88
FP60135-220	22,0	20	22	88
FP60135-250	25,0	25	26	102

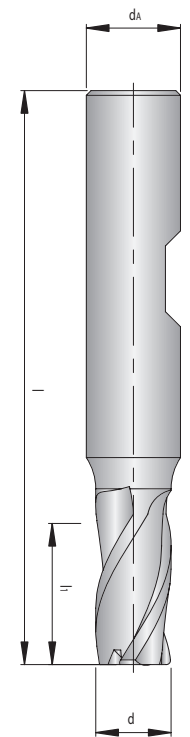

Toleranz / Tolerance (μm)	Nennwertbereich / Diameter range (mm)				
	≥ 1 -3	>3 -6	>6 -10	>10 -18	>18 -30
e8	-14 -28	-20 -38	-25 -47	-32 -59	-40 -73
h6	0 -6	0 -8	0 -9	0 -11	0 -13

FP

● = Hauptanwendung / Main application
○ = Nebenanwendung / Suitable

Alle Angaben in mm / Dimensions in mm

PM-HSS-Schaftfräser

3 Schneiden, kurze Ausführung



PM-HSS end-mill

3 flutes, short design

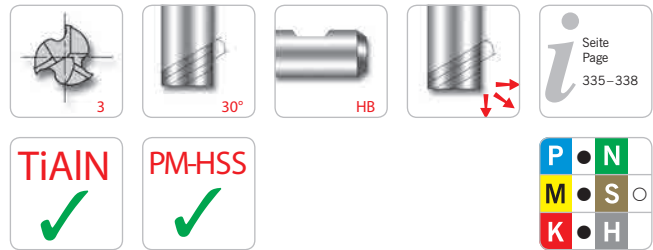

FP60130-...

Schaft / Shank DIN 6535HB	d e8	d _A h6	l ₁	l
FP60130-020	2,0	6	7	51
FP60130-030	3,0	6	8	52
FP60130-040	4,0	6	11	55
FP60130-050	5,0	6	13	57
FP60130-060	6,0	6	13	57
FP60130-070	7,0	10	16	66
FP60130-080	8,0	10	19	69
FP60130-090	9,0	10	19	69
FP60130-100	10,0	10	22	72
FP60130-120	12,0	12	26	83
FP60130-140	14,0	12	26	83
FP60130-160	16,0	16	32	92
FP60130-180	18,0	16	32	92
FP60130-200	20,0	20	38	104
FP60130-220	22,0	20	38	104
FP60130-250	25,0	25	45	121

Toleranz / Tolerance (μm)	Nennwertbereich / Diameter range (mm)				
	≥ 1 - 3	> 3 - 6	> 6 - 10	> 10 - 18	> 18 - 30
e8	-14 -28	-20 -38	-25 -47	-32 -59	-40 -73
h6	0 -6	0 -8	0 -9	0 -11	0 -13

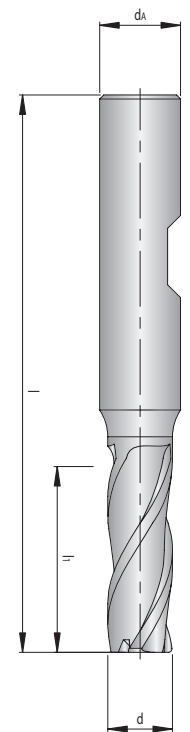

FP

● = Hauptanwendung / Main application
○ = Nebenanwendung / Suitable

Alle Angaben in mm / Dimensions in mm

PM-HSS-Schaftfräser

4 - 6 Schneiden, kurze Ausführung



PM-HSS end-mill

4 - 6 flutes, short design

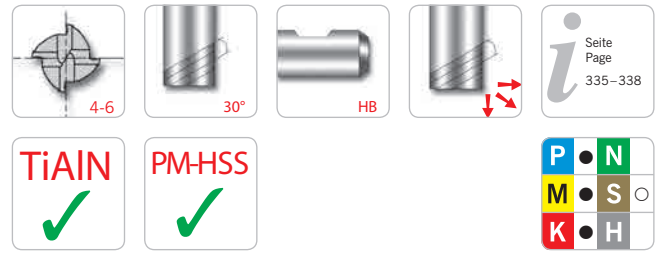

FP601.0-...

Schaft / Shank DIN 6535HB	d	d _A	l ₁	l	z
FP60140-020	2,0	6	7	51	4
FP60140-030	3,0	6	8	52	4
FP60140-040	4,0	6	11	55	4
FP60140-050	5,0	6	13	57	4
FP60140-060	6,0	6	13	57	4
FP60140-070	7,0	10	16	66	4
FP60140-080	8,0	10	19	69	4
FP60140-090	9,0	10	19	69	4
FP60140-100	10,0	10	22	72	4
FP60140-120	12,0	12	26	83	4
FP60140-140	14,0	12	26	83	4
FP60140-160	16,0	16	32	92	4
FP60140-180	18,0	16	32	92	4
FP60140-200	20,0	20	38	104	4
FP60140-220	22,0	20	38	104	4
FP60140-250	25,0	25	45	121	4
FP60160-280	28,0	25	45	121	6
FP60160-300	30,0	25	45	121	6
FP60160-320	32,0	32	53	133	6

Toleranz / Tolerance	
Fräser / Mill	+ 0,03 0
Schaft / Shank	h6

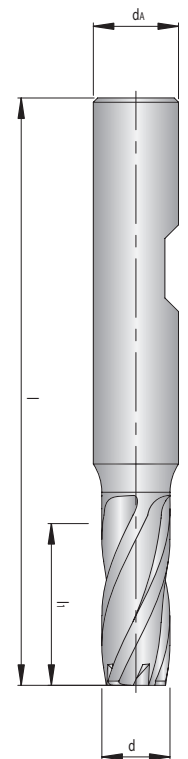

FP

PM-HSS-Schaftfräser

4 - 6 Schneiden, lange Ausführung



PM-HSS end-mill

4 - 6 flutes, long design

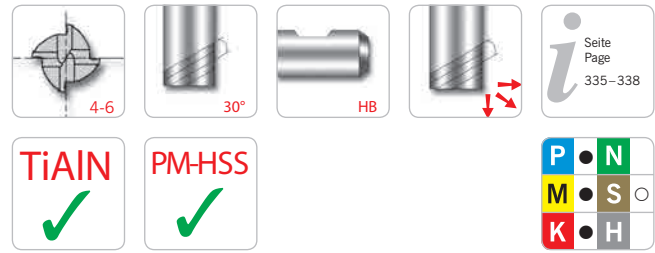

FP601.1-...

Schaft / Shank DIN 6535HB	d	d _A	l ₁	l	z
FP60141-020	2,0	6	10	54	4
FP60141-030	3,0	6	12	56	4
FP60141-040	4,0	6	19	63	4
FP60141-050	5,0	6	24	68	4
FP60141-060	6,0	6	24	68	4
FP60141-070	7,0	10	30	80	4
FP60141-080	8,0	10	38	88	4
FP60141-090	9,0	10	38	88	4
FP60141-100	10,0	10	45	95	4
FP60141-120	12,0	12	53	110	4
FP60141-140	14,0	12	53	110	4
FP60141-160	16,0	16	63	123	4
FP60141-180	18,0	16	63	123	4
FP60141-200	20,0	20	75	141	4
FP60141-220	22,0	20	75	141	4
FP60141-250	25,0	25	90	166	4
FP60161-280	28,0	25	90	166	6
FP60161-300	30,0	25	90	166	6
FP60161-320	32,0	32	106	186	6

Toleranz / Tolerance	
Fräser / Mill	+ 0,03 0
Schaft / Shank	h6

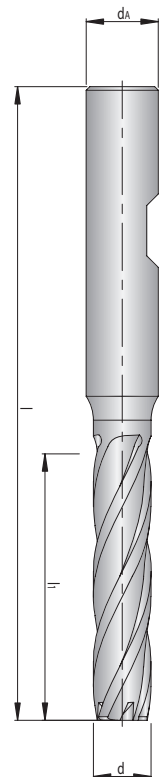

FP

● = Hauptanwendung / Main application
○ = Nebenanwendung / Suitable

Alle Angaben in mm / Dimensions in mm

PM-HSS-Schrupfräser

3 - 6 Schneiden, kurze Ausführung



PM-HSS roughing end-mill

3 - 6 flutes, short design

FP618.0-...

Schaft / Shank DIN 6535HB	d js12	d _A h6	l ₁	l	z
FP61830-060	6,0	6	13	57	3
FP61830-070	7,0	10	16	66	3
FP61830-080	8,0	10	19	69	3
FP61830-090	9,0	10	19	69	3
FP61840-100	10,0	10	22	72	4
FP61840-120	12,0	12	26	83	4
FP61840-140	14,0	12	26	83	4
FP61840-160	16,0	16	32	92	4
FP61840-180	18,0	16	32	92	4
FP61840-200	20,0	20	38	104	4
FP61850-220	22,0	20	38	104	5
FP61850-250	25,0	25	45	121	5
FP61860-280	28,0	25	45	121	6
FP61860-300	30,0	25	45	121	6
FP61860-320	32,0	32	53	133	6

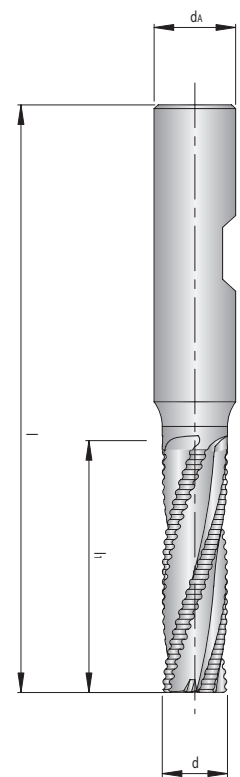

Toleranz / Tolerance (μm)	Nennwertbereich / Diameter range (mm)			
	> 6 - 10	> 10 - 18	> 18 - 30	30 - 50
js12	±75	±90	±105	±125
h6	0 -9	0 -11	0 -13	0 -16

FP

● = Hauptanwendung / Main application
○ = Nebenanwendung / Suitable

Alle Angaben in mm / Dimensions in mm

PM-HSS-Schrupfräser

3 - 6 Schneiden, mittellange Ausführung

PM-HSS roughing end-mill

3 - 6 flutes, mid-length design

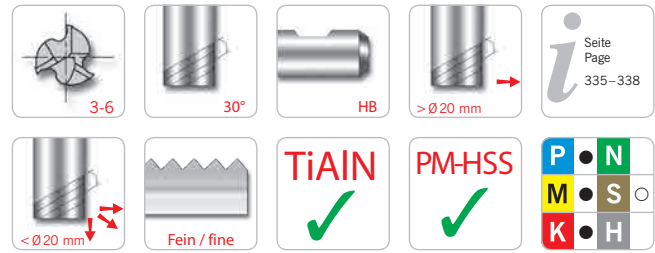

FP618.6-...

Schaft / Shank DIN 6535HB	d js12	d _A h6	l ₁	l	z
FP61836-060	6,0	6	19	63	3
FP61836-070	7,0	6	19	63	3
FP61836-080	8,0	10	28	74	3
FP61836-090	9,0	10	28	74	3
FP61846-100	10,0	10	35	84	4
FP61846-120	12,0	12	40	97	4
FP61846-140	14,0	12	40	97	4
FP61846-160	16,0	16	48	108	4
FP61846-180	18,0	16	48	108	4
FP61846-200	20,0	20	58	122	4
FP61856-220	22,0	20	58	122	5
FP61856-250	25,0	25	68	144	5
FP61866-280	28,0	25	68	144	6
FP61866-300	30,0	25	68	144	6
FP61866-320	32,0	32	78	158	6

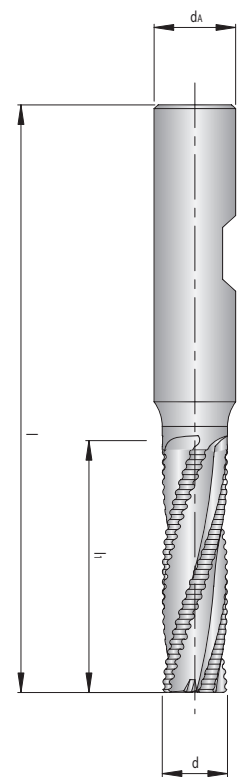

Toleranz / Tolerance (µm)	Nennwertbereich / Diameter range (mm)			
	> 6 - 10	> 10 - 18	> 18 - 30	30 - 50
js12	±75	±90	±105	±125
h6	0 -9	0 -11	0 -13	0 -16

SET-FP61836 TiAlN

SET-Inhalt SET, contains [Stück / Pcs.]	Schaft Shank	d js12	d _A h6	l ₁	l	z
2x -->	FP61836-060	6,0	6	19	63	3
2x -->	FP61836-080	8,0	10	28	74	3
2x -->	FP61836-100	10,0	10	35	84	4
2x -->	FP61836-120	12,0	12	40	97	4



Bestellbezeichnung / Ordering description: SET-FP61836 TiAlN

● = Hauptanwendung / Main application
○ = Nebenanwendung / Suitable

Alle Angaben in mm / Dimensions in mm

PM-HSS-Schrupfräser

3 - 6 Schneiden, lange Ausführung



PM-HSS roughing end-mill

3 - 6 flutes, long design

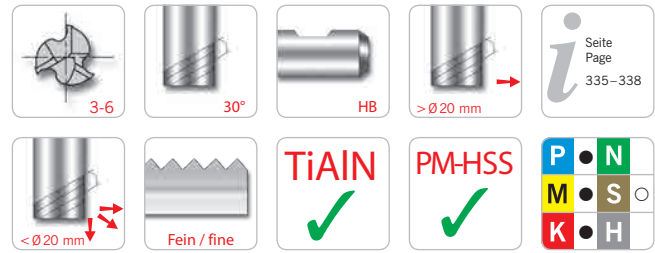

Seite
Page
335-338

FP618.1-...

Schaft / Shank DIN 6535HB	d js12	d _A h6	l ₁	l	z
FP61831-060	6,0	6	24	68	3
FP61831-070	7,0	10	30	80	3
FP61831-080	8,0	10	38	88	3
FP61831-090	9,0	10	38	88	3
FP61841-100	10,0	10	45	95	4
FP61841-120	12,0	12	53	110	4
FP61841-140	14,0	12	53	110	4
FP61841-160	16,0	16	63	123	4
FP61841-180	18,0	16	63	123	4
FP61841-200	20,0	20	75	141	4
FP61851-220	22,0	20	75	141	5
FP61851-250	25,0	25	90	166	5
FP61861-280	28,0	25	90	166	6
FP61861-300	30,0	25	90	166	6
FP61861-320	32,0	32	106	186	6

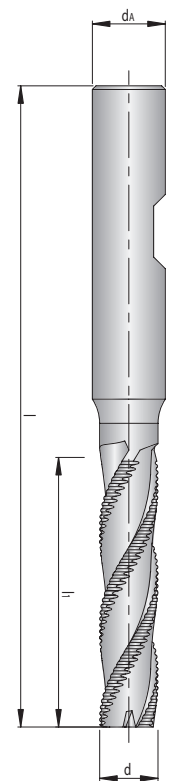

Toleranz / Tolerance (μm)	Nennwertbereich / Diameter range (mm)			
	> 6 - 10	> 10 - 18	> 18 - 30	30 - 50
js12	±75	±90	±105	±125
h6	0 -9	0 -11	0 -13	0 -16

FP

● = Hauptanwendung / Main application
○ = Nebenanwendung / Suitable

Alle Angaben in mm / Dimensions in mm

PM-HSS-Schrupfräser

4 - 6 Schneiden, extra kurze Ausführung



PM-HSS roughing end-mill

4 - 6 flutes, extra short design

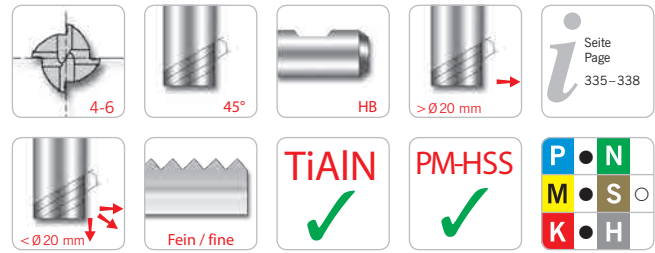

FP619.5-...

Schaft / Shank DIN 6535HB	d js12	d _A h6	l ₁	l ₂	l	z
FP61945-060	6,0	6	8	-	52	4
FP61945-080	8,0	10	11	-	61	4
FP61945-100	10,0	10	13	23,0	63	4
FP61945-120	12,0	12	16	28,0	73	4
FP61955-140	14,0	12	16	-	73	5
FP61955-160	16,0	16	19	31,0	79	5
FP61965-180	18,0	16	19	-	79	6
FP61965-200	20,0	20	22	38,0	88	6
FP61965-250	25,0	25	26	46,0	102	6

Toleranz / Tolerance (μm)	Nennwertbereich / Diameter range (mm)		
	> 6 - 10	> 10 - 18	> 18 - 30
js12	± 75	± 90	± 105
h6	0 -9	0 -11	0 -13

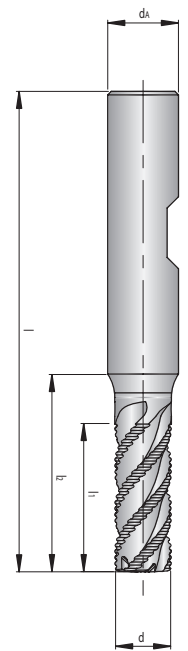

FP

● = Hauptanwendung / Main application
○ = Nebenanwendung / Suitable

Alle Angaben in mm / Dimensions in mm

PM-HSS-Schrupfräser

3 - 6 Schneiden, kurze Ausführung



PM-HSS roughing end-mill

3 - 6 flutes, short design

FP619.0-...

Schaft / Shank DIN 6535HB	d js12	d _A h6	d ₃	l ₁	l ₂	l	z
FP61930-040	4,0	6	-	11	-	57	3
FP61940-050	5,0	6	-	13	-	57	4
FP61940-060	6,0	6	-	13	-	57	4
FP61940-070	7,0	10	-	16	-	66	4
FP61940-080	8,0	10	-	19	-	69	4
FP61940-090	9,0	10	-	19	-	69	4
FP61940-100	10,0	10	9,50	22	31,0	72	4
FP61940-110	11,0	12	10,50	22	27,0	80	4
FP61940-120	12,0	12	11,50	26	37,0	83	4
FP61940-130	13,0	12	-	26	-	84	4
FP61950-140	14,0	12	-	26	-	83	5
FP61950-150	15,0	12	-	26	-	85	5
FP61950-160	16,0	16	15,00	32	44,0	92	5
FP61960-180	18,0	16	-	32	-	92	6
FP61960-200	20,0	20	19,00	38	54,0	104	6
FP61960-250	25,0	25	24,00	45	63,0	121	6

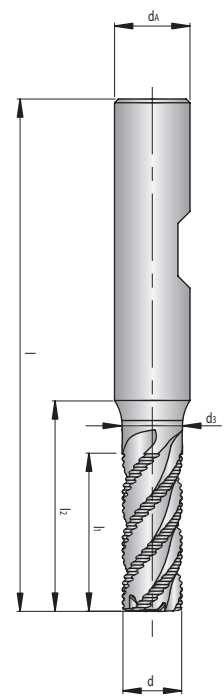

Toleranz / Tolerance (µm)	Nennwertbereich / Diameter range (mm)			
	>3 -6	>6 -10	>10 -18	>18 -30
js12	±60	±75	±90	±105
h6	0 -8	0 -9	0 -11	0 -13

FP

● = Hauptanwendung / Main application
○ = Nebenanwendung / Suitable

Alle Angaben in mm / Dimensions in mm

PM-HSS-Schrupfräser

3 - 6 Schneiden, kurze Ausführung



PM-HSS roughing end-mill

3 - 6 flutes, short design

FP620.0-...

Schaft / Shank DIN 6535HB	d js12	d _A h6	l ₁	l	z
FP62030-060	6,0	6	13	57	3
FP62030-070	7,0	10	16	66	3
FP62030-080	8,0	10	19	69	3
FP62030-090	9,0	10	19	69	3
FP62040-100	10,0	10	22	72	4
FP62040-120	12,0	12	26	83	4
FP62040-140	14,0	12	26	83	4
FP62040-160	16,0	16	32	92	4
FP62040-180	18,0	16	32	92	4
FP62040-200	20,0	20	38	104	4
FP62050-220	22,0	20	38	104	5
FP62050-250	25,0	25	45	121	5
FP62060-300	30,0	25	45	121	6
FP62060-320	32,0	32	53	133	6

Toleranz / Tolerance (µm)	Nennwertbereich / Diameter range (mm)			
	>6 -10	>10 -18	>18 -30	30 -50
js12	±75	±90	±105	±125
h6	0 -9	0 -11	0 -13	0 -16

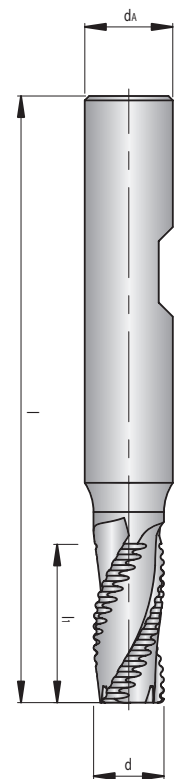

FP

● = Hauptanwendung / Main application
○ = Nebenanwendung / Suitable

Alle Angaben in mm / Dimensions in mm

PM-HSS-Schrupfräser

3 - 6 Schneiden, lange Ausführung



PM-HSS roughing end-mill

3 - 6 flutes, long design

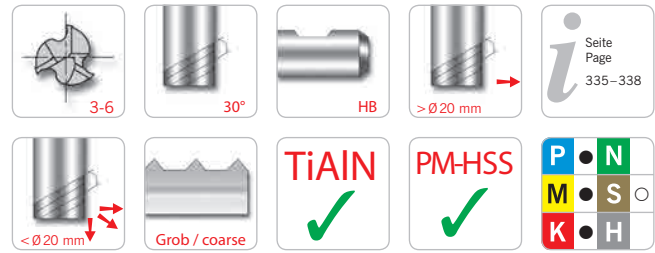

FP620.1-...

Schaft / Shank DIN 6535HB	d js12	d _A h6	l ₁	l	z
FP62031-060	6,0	6	24	68	3
FP62031-070	7,0	10	30	80	3
FP62031-080	8,0	10	38	88	3
FP62031-090	9,0	10	38	88	3
FP62041-100	10,0	10	45	95	4
FP62041-120	12,0	12	53	110	4
FP62041-140	14,0	12	53	110	4
FP62041-160	16,0	16	63	123	4
FP62041-180	18,0	16	63	123	4
FP62041-200	20,0	20	75	141	4
FP62051-220	22,0	20	75	141	5
FP62051-250	25,0	25	90	166	5
FP62061-280	28,0	25	90	166	6
FP62061-300	30,0	25	90	166	6
FP62061-320	32,0	32	106	186	6

Toleranz / Tolerance (µm)	Nennwertbereich / Diameter range (mm)			
	> 6 - 10	> 10 - 18	> 18 - 30	30 - 50
js12	±75	±90	±105	±125
h6	0 -9	0 -11	0 -13	0 -16

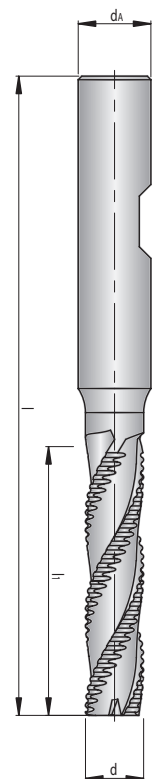

FP

PM-HSS-Schrupfräser

4-5 Schneiden, extra lange Ausführung



N NEU/NEW

PM-HSS roughing end-mill

4-5 flutes, extra long design

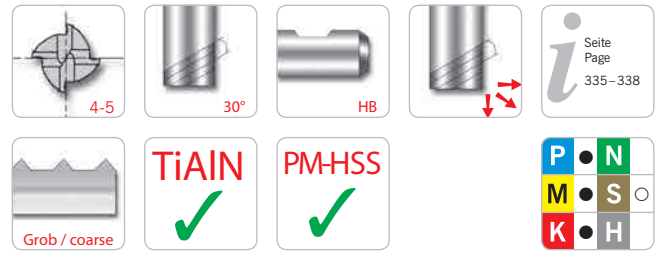

FP623.1-...

Schaft / Shank DIN 6535HB	d js12	d _A h6	d ₃	l ₁	l ₂	l	z
FP62341-100 N	10,0	10	8,50	22	69,0	110	4
FP62341-120 N	12,0	12	10,50	26	78,0	125	4
FP62341-160 N	16,0	16	14,00	32	87,0	138	4
FP62341-200 N	20,0	20	18,00	38	108,0	160	4
FP62351-250 N	25,0	25	23,00	45	155,0	216	5

Toleranz / Tolerance (μm)	Nennwertbereich / Diameter range (mm)		
	>6 -10	>10 -18	>18 -30
js12	±75	±90	±105
h6	0 -9	0 -11	0 -13

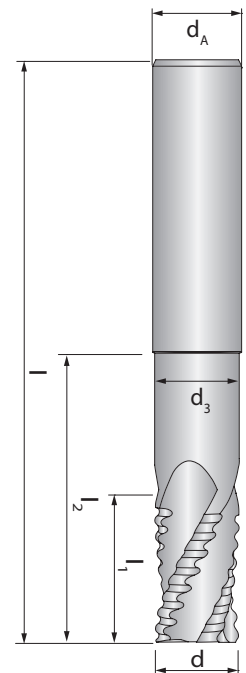

FP

● = Hauptanwendung / Main application
○ = Nebenanwendung / Suitable

Alle Angaben in mm / Dimensions in mm

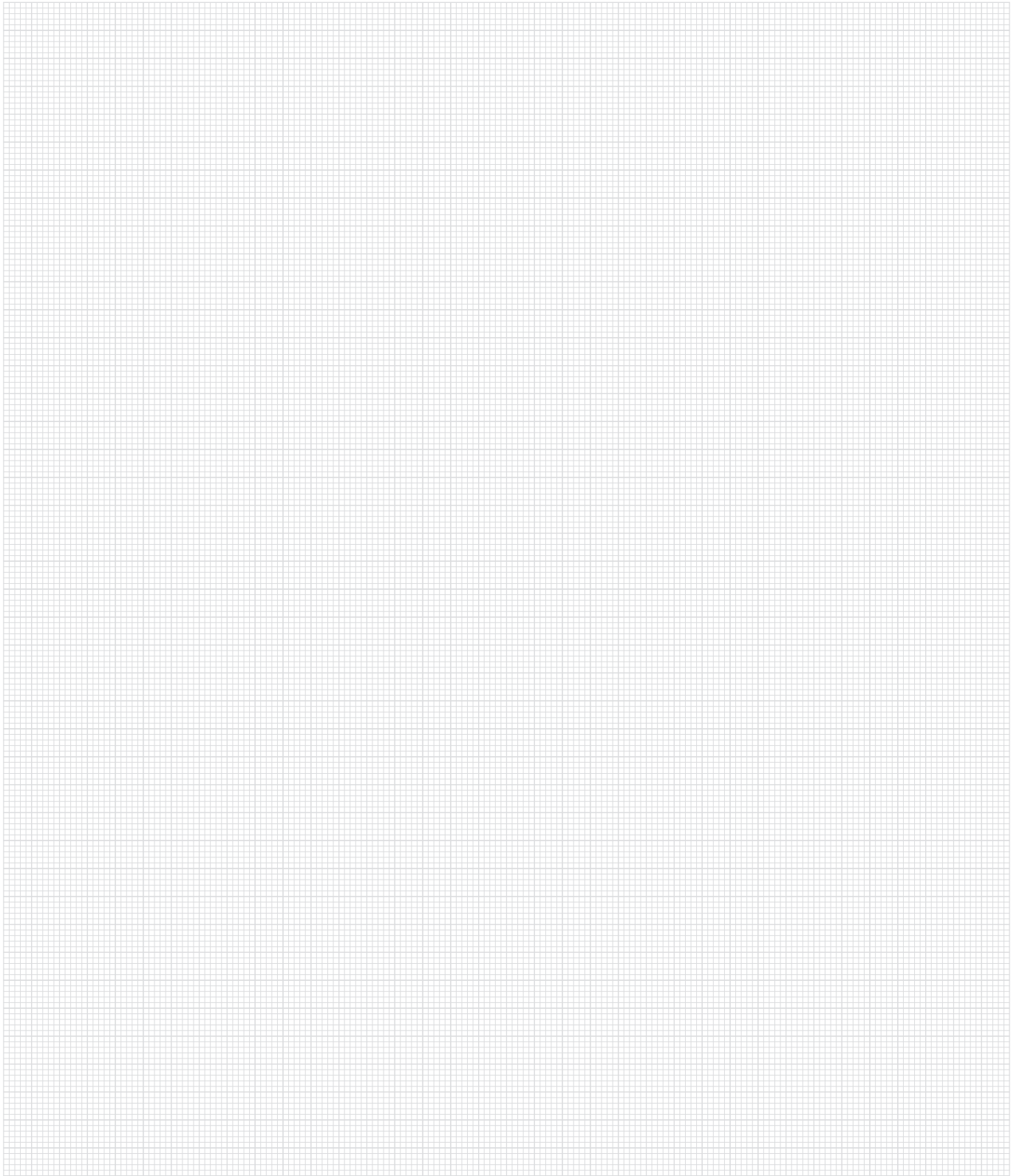

ARNO[®]
WERKZEUGE

Weitere Informationen finden Sie unter:
For more information see:

www.arno.de

ARNO[®]

WERKZEUGE

We have a passion for precision.

AUSFÜHRUNG FS

Design FS

**Beste Leistungen beim Zerspanen
von Stahl, rostfreiem Stahl und Gusswerkstoffen.**

**General purpose for
steel, stainless steel and cast materials.**

Der TiAlN-beschichtete HSS-Universalfräser bietet eine verbesserte Hitze- und Oxidationsbeständigkeit und ist dadurch extrem temperaturresistent. Auch zum Trockenfräsen bestens geeignet.



Universal cutters with TiAlN coating offer improved heat and oxidation resistance. Cutters can therefore also be run dry.

HSS-Schaftfräser

2 Schneiden, kurze Ausführung



HSS end-mill

2 flutes, short design



FS60120-...

Schaft / Shank DIN 6535HB	d e8	d _A h6	l ₁	l
FS60120-010	1,0	6	2,5	47
FS60120-015	1,5	6	3	47
FS60120-020	2,0	6	4	48
FS60120-030	3,0	6	5	49
FS60120-040	4,0	6	7	51
FS60120-050	5,0	6	8	52
FS60120-060	6,0	6	8	52
FS60120-080	8,0	10	11	61
FS60120-100	10,0	10	13	63
FS60120-120	12,0	12	16	73
FS60120-140	14,0	12	16	73
FS60120-160	16,0	16	19	79
FS60120-180	18,0	16	19	79
FS60120-200	20,0	20	22	88

Toleranz / Tolerance (μm)	Nennwertbereich / Diameter range (mm)				
	≥ 1 -3	>3 -6	>6 -10	>10 -18	>18 -30
e8	-14 -28	-20 -38	-25 -47	-32 -59	-40 -73
h6	0 -6	0 -8	0 -9	0 -11	0 -13

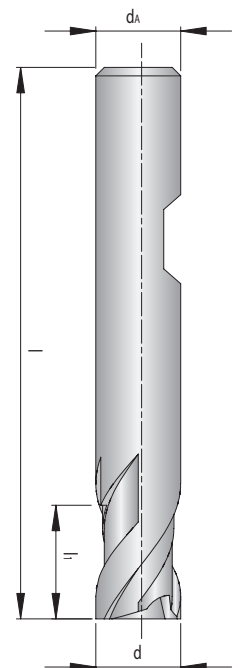

FS

HSS-Radiusfräser

2 Schneiden, kurze Ausführung

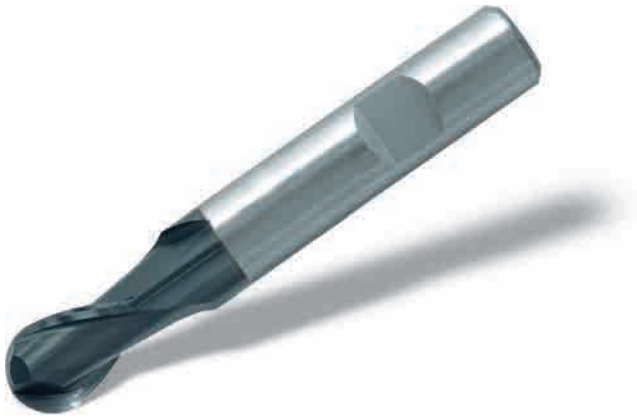

HSS ball-nose end-mill

2 flutes, short design



FS60320-...

Schaft / Shank DIN 6535HB	d e8	d _A h6	l ₁	l	R +/- 0,02
FS60320-020	2,0	6	4	48	1,00
FS60320-030	3,0	6	5	49	1,50
FS60320-040	4,0	6	7	51	2,00
FS60320-050	5,0	6	8	52	2,50
FS60320-060	6,0	6	8	52	3,00
FS60320-080	8,0	10	11	61	4,00
FS60320-100	10,0	10	13	63	5,00
FS60320-120	12,0	12	16	73	6,00
FS60320-160	16,0	16	19	79	8,00
FS60320-200	20,0	20	22	88	10,00

Toleranz / Tolerance (μm)	Nennwertbereich / Diameter range (mm)				
	≥ 1 -3	> 3 -6	> 6 -10	> 10 -18	> 18 -30
e8	-14 -28	-20 -38	-25 -47	-32 -59	-40 -73
h6	0 -6	0 -8	0 -9	0 -11	0 -13

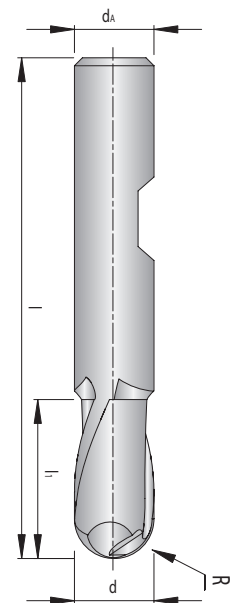

● = Hauptanwendung / Main application
○ = Nebenanwendung / Suitable

Alle Angaben in mm / Dimensions in mm

HSS-Schaftfräser

4 Schneiden, kurze Ausführung



HSS end-mill

4 flutes, short design

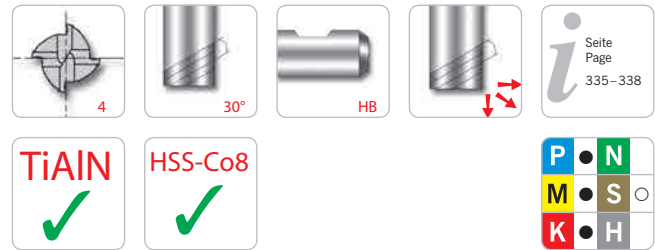

FS60140-...

Schaft / Shank DIN 6535HB	d	d _A	l ₁	l
FS60140-020	2,0	6	7	51
FS60140-030	3,0	6	8	52
FS60140-040	4,0	6	11	55
FS60140-050	5,0	6	13	57
FS60140-060	6,0	6	13	57
FS60140-080	8,0	10	19	69
FS60140-100	10,0	10	22	72
FS60140-120	12,0	12	26	83
FS60140-140	14,0	12	26	83
FS60140-160	16,0	16	32	92
FS60140-180	18,0	16	32	92
FS60140-200	20,0	20	38	104

Toleranz / Tolerance	
Fräser / Mill	+ 0,04 0
Schaft / Shank	h6

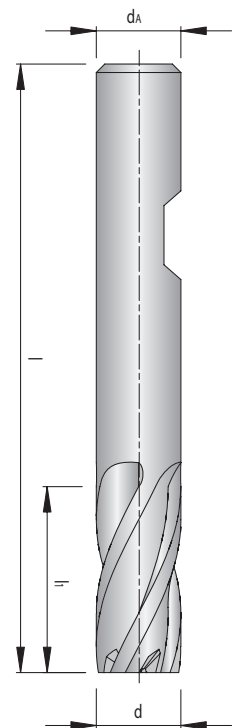

FS

HSS-Schrupfräser

3-4 Schneiden, kurze Ausführung



HSS-roughing end-mill

3-4 flutes, short design

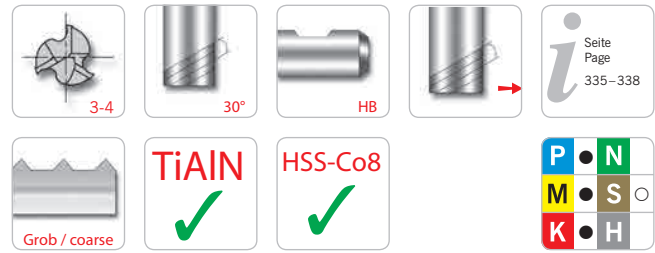

FS618.0-...

Schaft / Shank DIN 6535HB	d js12	d _A h6	l ₁	l	z
FS61830-060	6,0	6	13	57	3
FS61830-080	8,0	10	19	69	3
FS61840-100	10,0	10	22	72	4
FS61840-120	12,0	12	26	83	4
FS61840-140	14,0	12	26	83	4
FS61840-160	16,0	16	32	92	4
FS61840-180	18,0	16	32	92	4
FS61840-200	20,0	20	38	104	4

Toleranz / Tolerance (μm)	Nennwertbereich / Diameter range (mm)		
	> 6 -10	> 10 -18	> 18 -30
js12	±75	±90	±105
h6	0 -9	0 -11	0 -13

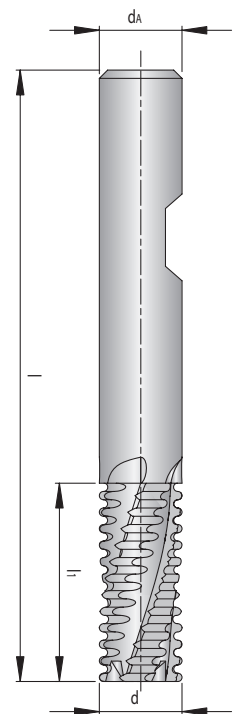

FS

● = Hauptanwendung / Main application
○ = Nebenanwendung / Suitable

Alle Angaben in mm / Dimensions in mm

HSS-Schrupfräser

3-4 Schneiden, kurze Ausführung



HSS-roughing end-mill

3-4 flutes, short design

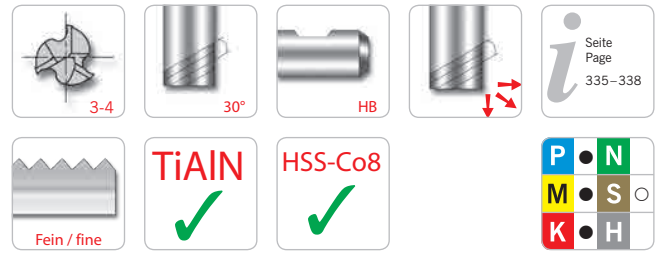

FS620.0-...

Schaft / Shank DIN 6535HB	d js12	d _A h6	l ₁	l	z
FS62030-060	6,0	6	13	57	3
FS62030-080	8,0	10	19	69	3
FS62040-100	10,0	10	22	72	4
FS62040-120	12,0	12	26	83	4
FS62040-140	14,0	12	26	83	4
FS62040-160	16,0	16	32	92	4
FS62040-180	18,0	16	32	92	4
FS62040-200	20,0	20	38	104	4

Toleranz / Tolerance (μm)	Nennwertbereich / Diameter range (mm)		
	> 6 - 10	> 10 - 18	> 18 - 30
js12	±75	±90	±105
h6	0 -9	0 -11	0 -13

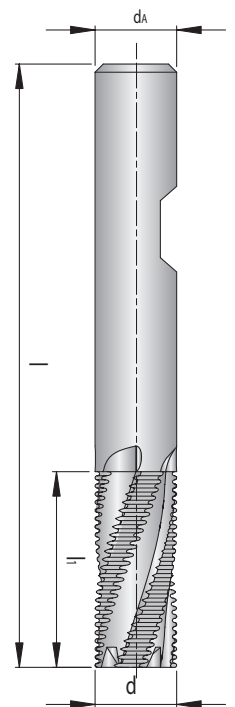

Empfohlene Schnittwerte PM- und HSS-Schafffräser

Ausführung FP, FS

ISO	Werkstoff	Festigkeit [N/mm ²]	Vorschub-Korrekturfaktor [x f _z]	beschichtet
				V _c [m/min]
P	Allgemeiner Baustahl	< 800	1,2	60-85
	Automatenstahl	< 800	1,2	50-70
	Einsatzstahl, unlegiert	< 800	1,2	45-60
	Einsatzstahl, legiert	< 1000	1	40-60
	Vergütungsstahl, unlegiert	< 850	1,2	45-60
	Vergütungsstahl, unlegiert	< 1000	1	30-40
	Vergütungsstahl, legiert	< 800	1,2	40-60
	Vergütungsstahl, legiert	< 1300	0,8	30-40
	Stahlguss	< 850	1,2	45-60
	Nitrierstahl	< 1000	1	30-40
	Nitrierstahl	< 1200	0,8	30-40
	Wälzlagerstahl	< 1200	0,8	30-40
	Federstahl	< 1200		
	Schnellarbeitsstahl	< 1300		
	Werkzeugstahl für Kaltarbeit	< 1300	0,8	25-35
	Werkzeugstahl für Warmarbeit	< 1300	0,8	20-30
M	Stahl und Stahlguss, rostfrei geschwefelt	< 850	1	20-30
	Nichtrostender Stahl, ferritisch	< 750	1	20-30
	Nichtrostender Stahl, martensitisch	< 900	1	15-25
	Nichtrostender Stahl, ferritisch/martensitisch	< 1100	0,9	15-20
	Nichtrostender Stahl, austenitisch/ferritisch	< 850	1	10-15
	Nichtrostender Stahl, austenitisch	< 750	1	20-30
K	Hitzebeständig	< 1100		
	Grauguss mit Lammellengraphit	100-350	1	35-50
	Grauguss mit Lammellengraphit	300-1000	1	25-35
	Kugelgraphitguss	300-500	1	30-40
	Kugelgraphitguss	550-800	1	30-40
	Temperguss, weiß	350-450	1	35-45
	Temperguss, weiß	500-650	1	35-45
	Temperguss, schwarz	350-450	1	30-40
Temperguss, schwarz	500-700	0,8	25-35	
N	Aluminium (unlegiert, niedrig legiert)	< 350	1,9	250-280
	Aluminiumlegierungen < 0,5% Si	< 500	1,9	140-170
	Aluminiumlegierungen 0,5 - 10% Si	< 400	1,8	120-150
	Aluminiumlegierungen 10 - 15% Si	< 400	1,7	70-140
	Aluminiumlegierungen > 15% Si	< 400		
	Kupfer (unlegiert, niedrig legiert)	< 350	1,2	70-90
	Kupfer-Knetlegierungen	< 700	1,1	120-160
	Kupfer-Sonderlegierungen	< 200 HB	0,9	15-20
	Kupfer-Sonderlegierungen	< 300 HB		
	Kupfer-Sonderlegierungen	> 300 HB		
	Messing kurzspanend, Bronze, Rotguss	< 600	1,1	120-160
	Messing langspanend	< 600	1,1	130-170
	Thermoplaste		2	30-50
	Duroplaste		2	60-80
	Faserverstärkte Kunststoffe			
	Magnesium und Magnesiumlegierungen	< 850	1,8	150-180
Graphit		1	35-45	
Wolfram und Wolframlegierungen		1,1	10-20	
Molybdän und Molybdänlegierungen				
S	Reinnickel		1,1	10-15
	Nickellegierungen			
	Nickellegierungen	< 850	1,1	16-25
	Nickel-Chromlegierungen			
	Nickel- und Kobaltlegierungen	< 1300	0,7	15-20
	Hochwarmfeste Legierungen	< 1300		
	Nickel-Kobalt-(Chrom-)legierungen	< 1400	0,9	10-16
	Nickel- und Kobaltlegierungen	< 1300	1	9-14
	Reintitan	< 900	1	20-30
	Titanlegierungen	< 700	1,1	20-25
H	Titanlegierungen	< 1200		
	Stahl gehärtet	< 45 HRC		
		46-55 HRC		
		56-60 HRC		
		61-65 HRC		
	65-70 HRC			

Achtung: Für das Vollnutfräsen ist der Vorschub um 15–20% zu reduzieren.

Die Tabellenwerte sind Richtwerte. Es kann notwendig sein, die Werte den jeweiligen Bearbeitungsumständen anzupassen.

Recommended cutting PM- and HSS end-mill

Design FP, FS

ISO	Material	Strength [N/mm ²]	Correction factor [x f _z]	coated
				V _c [m/min]
P	General construction steel	< 800	1,2	60-85
	Free cutting steel	< 800	1,2	50-70
	Case hardened steel, non alloyed	< 800	1,2	45-60
	Alloyed case hardened steel	< 1000	1	40-60
	Tempering steel, non alloyed	< 850	1,2	45-60
	Tempering steel, non alloyed	< 1000	1	30-40
	Tempering steel, alloyed	< 800	1,2	40-60
	Tempering steel, alloyed	< 1300	0,8	30-40
	Steel castings	< 850	1,2	45-60
	Nitriding steel	< 1000	1	30-40
	Nitriding steel	< 1200	0,8	30-40
	Roller bearing steel	< 1200	0,8	30-40
	Spring steel	< 1200		
	High-speed steel	< 1300		
	Cold working tool steel	< 1300	0,8	25-35
	Hot working tool steel	< 1300	0,8	20-30
M	Steel and sulphured cast stainless steel	< 850	1	20-30
	Stainless steel, ferritic	< 750	1	20-30
	Stainless steel, martensitic	< 900	1	15-25
	Stainless steel, ferritic/martensitic	< 1100	0,9	15-20
	Stainless steel, austenitic/ferritic	< 850	1	10-15
	Stainless steel, austenitic	< 750	1	20-30
	Heat resistant steel	< 1100		
K	Grey cast iron with lamellar graphite	100-350	1	35-50
	Grey cast iron with lamellar graphite	300-1000	1	25-35
	Spheroidal cast iron	300-500	1	30-40
	Spheroidal cast iron	550-800	1	30-40
	White cast iron, tempered	350-450	1	35-45
	White cast iron, tempered	500-650	1	35-45
	Black cast iron, tempered	350-450	1	30-40
	Black cast iron, tempered	500-700	0,8	25-35
N	Aluminium (non alloyed, low alloyed)	< 350	1,9	250-280
	Aluminium alloys < 0,5% Si	< 500	1,9	140-170
	Aluminium alloys 0,5% - 10% Si	< 400	1,8	120-150
	Aluminium alloys 10% - 15% Si	< 400	1,7	70-140
	Aluminium alloys > 15% Si	< 400		
	Copper (non alloyed, low alloyed)	< 350	1,2	70-90
	Copper wrought alloys	< 700	1,1	120-160
	Special copper alloys	< 200 HB	0,9	15-20
	Special copper alloys	< 300 HB		
	Special copper alloys	> 300 HB		
	Short-chipping brass, bronze, red bronze	< 600	1,1	120-160
	Long-chipping brass	< 600	1,1	130-170
	Thermoplastics		2	30-50
	Duroplastics		2	60-80
	Fibre-reinforced plastics			
	Magnesium and magnesium alloys	< 850	1,8	150-180
Graphite		1	35-45	
Tungsten and tungsten alloys		1,1	10-20	
Molybdenum and molybdenum alloys				
S	Pure nickel		1,1	10-15
	Nickel alloys			
	Nickel alloys	< 850	1,1	16-25
	Nickel-chromium alloys			
	Nickel and cobalt alloys	< 1300	0,7	15-20
	Nickel and cobalt alloys	< 1300		
	Heat resistant alloys	< 1400	0,9	10-16
	Nickel-cobalt-chromium alloys	< 1300	1	9-14
	Pure titanium	< 900	1	20-30
	Titanium alloys	< 700	1,1	20-25
Titanium alloys	< 1200			
H	Tempered steel	< 45 HRC		
		46-55 HRC		
		56-60 HRC		
		61-65 HRC		
		65-70 HRC		

Attention: For full slot machining reduce V_c around 15–20%.

The recommended cutting data are only approximate values. It may be necessary to adjust them to each individual machining application.

Vorschub pro Zahn f_z [mm]

Feed per tooth f_z [mm]

Vollmaßfräsen (in einem Schnitt) Full slot milling (in one cut)		Untermaßfräsen (im Rahmen) Profile slot milling (internal profile milling)		Bohrfräsen Circular ramping	
d_1 [mm]	beschichtet / coated	beschichtet / coated		beschichtet / coated	beschichtet / coated
	f_z [mm]	Schuppen / Roughing f_z [mm]	Schichten / Fine cutting f_z [mm]	f_z [mm]	f_z [mm]
1,0	0,003	0,003	0,005	0,002	0,001
1,5	0,005	0,005	0,007	0,002	0,001
2,0	0,006	0,006	0,009	0,003	0,002
3,0	0,010	0,010	0,016	0,005	0,003
4,0	0,013	0,013	0,024	0,007	0,004
5,0	0,017	0,017	0,033	0,009	0,006
6,0	0,022	0,022	0,043	0,011	0,007
7,0	0,026	0,025	0,051	0,012	0,008
8,0	0,029	0,029	0,061	0,014	0,010
9,0	0,032	0,032	0,071	0,016	0,011
10,0	0,037	0,037	0,082	0,019	0,012
12,0	0,044	0,044	0,101	0,022	0,015
14,0	0,054	0,054	0,118	0,027	0,018
16,0	0,062	0,062	0,135	0,031	0,021
18,0	0,072	0,072	0,151	0,036	0,024
20,0	0,078	0,078	0,167	0,039	0,026
22,0	0,088	0,088	0,184	0,044	0,029
25,0	0,098	0,098	0,208	0,049	0,033
28,0	0,108	0,108	0,217	0,052	0,039
30,0	0,120	0,120	0,230	0,060	0,041
32,0	0,135	0,135	0,251	0,071	0,048
40,0	0,150	0,150	0,260	0,070	0,050

Achtung:
Optimale Ergebnisse werden im Gleichläuffräsen erzielt.

Attention:
For optimal results it is recommended to climb mill.

Generelle Berechnungsformeln/General rule:
Vorschub pro Zahn/Feed per tooth: = $f_z \cdot K_f$ (f_z)

Bohrvorschub (Fräsen in axialer Richtung): = Tabellenwert/Zähnezahl
For axial plunge milling: = Table value/Number of teeth

Alle Angaben in mm / Dimensions in mm

Vorschub pro Zahn f_z [mm]

Feed per tooth f_z [mm]

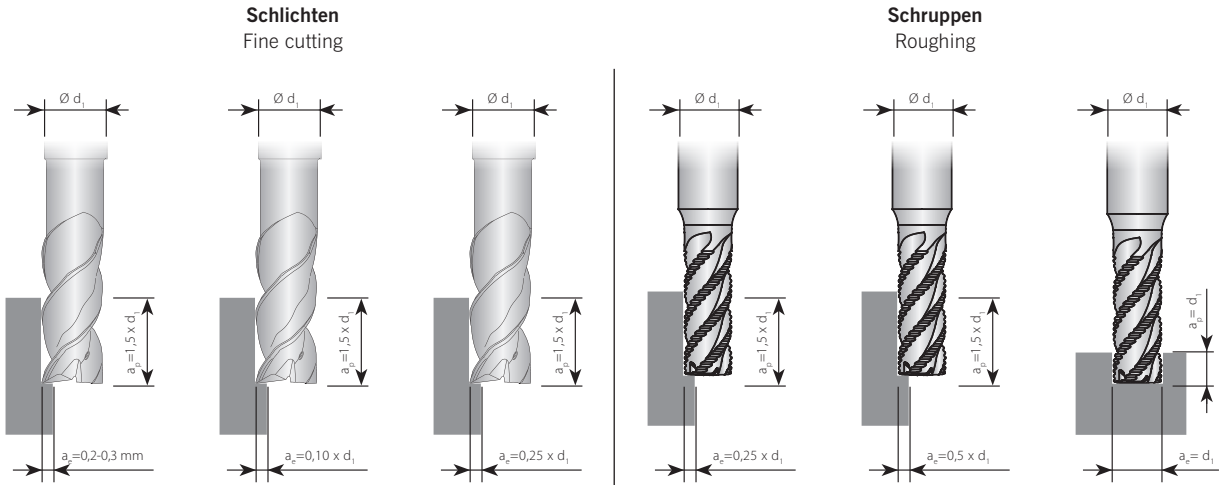

beschichtet / coated				beschichtet / coated		
d_1 [mm]	Schlichtgeometrie / Geometry for peripheral milling			Schruppgeometrie / Geometry for roughing		
	f_z [mm]	f_z [mm]	f_z [mm]	f_z [mm]	f_z [mm]	f_z [mm]
1,0	0,005	0,005	0,005	0,005	0,005	0,005
1,5	0,007	0,007	0,007	0,007	0,007	0,007
2,0	0,009	0,009	0,009	0,010	0,010	0,008
3,0	0,012	0,012	0,010	0,013	0,012	0,010
4,0	0,018	0,015	0,014	0,016	0,014	0,012
5,0	0,026	0,020	0,015	0,021	0,018	0,016
6,0	0,035	0,024	0,017	0,027	0,022	0,019
7,0	0,045	0,028	0,021	0,031	0,027	0,022
8,0	0,051	0,032	0,022	0,036	0,030	0,026
9,0	0,061	0,036	0,025	0,052	0,034	0,031
10,0	0,072	0,041	0,028	0,047	0,039	0,034
12,0	0,091	0,049	0,034	0,057	0,047	0,041
14,0	0,106	0,059	0,041	0,069	0,058	0,050
16,0	0,121	0,067	0,046	0,079	0,066	0,057
18,0	0,136	0,077	0,053	0,093	0,078	0,067
20,0	0,151	0,083	0,057	0,101	0,084	0,073
22,0	0,166	0,094	0,065	0,114	0,096	0,082
25,0	0,188	0,104	0,072	0,129	0,108	0,093
28,0	0,210	0,120	0,083	0,150	0,125	0,108
30,0	0,225	0,127	0,088	0,161	0,135	0,116
32,0	0,240	0,137	0,094	0,173	0,145	0,125
40,0	0,240	0,170	0,120	0,200	0,160	0,140

FP
FS

Achtung:
Optimale Ergebnisse werden im Gleichlaufräsen erzielt.

Attention:
For optimal results it is recommended to climb mill.

Generelle Berechnungsformeln/General rule:
Vorschub pro Zahn/Feed per tooth: = $f_z \cdot K_f$ (f_z)

Bohrvorschub (Fräsen in axialer Richtung): = Tabellenwert / Zähnezahl
For axial plunge milling: = Table value / Number of teeth

Alle Angaben in mm / Dimensions in mm

ARNO[®]

WERKZEUGE

We have a passion for precision.

VHM-GEWINDEFÄSER

Solid carbide thread milling cutters

Ausführung







- AFT** - Gewindefräser ISO-Innengewinde
- Gewindefräser UNC-Innengewinde
 - Gewindefräser UNF-Innengewinde
 - Gewindefräser BSP(G)-Innengewinde
 - Gewindefräser NPT-Innengewinde

Design

- AFT** - Thread milling cutter ISO - internal thread
- Thread milling cutter UNC - internal thread
 - Thread milling cutter UNF - internal thread
 - Thread milling cutter BSP(G) - internal thread
 - Thread milling cutter NPT - internal thread



Bezeichnung Description	Schneiden Flutes	Fräsertyp Type	Ausführung Design	Spiralwinkel Helix angle	Abb. Picture	Seite Page
AFT - Gewindefräser ISO-Innengewinde / Thread milling cutter ISO-internal thread						
AFT525.1-ISO...	3 - 5	Gewindefräser ISO - Innengewinde Thread milling cutter ISO - internal thread	mittellang medium length	15°		344
AFT525.1-ISO...IK	3 - 5	Gewindefräser ISO - Innengewinde Thread milling cutter ISO - internal thread	mittellang mit Innenkühlung medium length with through tool coolant	15°		345
AFT525.1-ISO...IK-F	3 - 4	Gewindefräser ISO - Innengewinde Thread milling cutter ISO - internal thread	mittellang mit Innen- kühlung und Fase medium length with through tool coolant and chamfers	15°		346
AFT525.0-ISO...	3 - 5	Gewindefräser ISO - Innengewinde Thread milling cutter ISO - internal thread	kurz short	15°		347
AFT525.0-ISO...-IK	3 - 5	Gewindefräser ISO - Innengewinde Thread milling cutter ISO - internal thread	kurz mit Innenkühlung short with through tool coolant	15°		348
AFT525.0-ISO...-IK-F	3 - 5	Gewindefräser ISO - Innengewinde Thread milling cutter ISO - internal thread	kurz mit Innenkühlung und Fase short with through tool coolant and chamfers	15°		349
AFT52534-ISO...	3	Gewindefräser ISO - Innengewinde Thread milling cutter ISO - internal thread	mini	15°		350
AFT52621-ISO...-IK-F	2	Gewindefräser ISO - Innengewinde Thread milling cutter ISO - internal thread	lang mit Innenkühlung und Fase long with through tool coolant and chamfers	15°		351

Bezeichnung Description	Schneiden Flutes	Fräsertyp Type	Ausführung Design	Spiralwinkel Helix angle	Abb. Picture	Seite Page
AFT - Gewindefräser UNC-Innengewinde / Thread milling cutter UNC-internal thread						
AFT525.1-UNC...	3 - 5	Gewindefräser UNC - Innengewinde Thread milling cutter UNC - internal thread	mittellang medium length	15°		352
AFT525.1-UNC...IK-F	3 - 5	Gewindefräser UNC - Innengewinde Thread milling cutter UNC - internal thread	mittellang mit Innen- kühlung und Fase medium length with through tool coolant and chamfers	15°		353
AFT52534-UNC...	3	Gewindefräser UNC - Innengewinde Thread milling cutter UNC - internal thread	mini	15°		354
AFT - Gewindefräser UNF-Innengewinde / Thread milling cutter UNF-internal thread						
AFT525.1-UNF...	3 - 5	Gewindefräser UNF - Innengewinde Thread milling cutter UNF - internal thread	mittellang medium length	15°		355
AFT525.1-UNF...IK-F	3 - 5	Gewindefräser UNF - Innengewinde Thread milling cutter UNF - internal thread	mittellang mit Innen- kühlung und Fase medium length with through tool coolant and chamfers	15°		356
AFT - Gewindefräser BSP(G)-Innengewinde / Thread milling cutter BSP(G)-internal thread						
AFT525.1-BSP...IK	3 - 5	Gewindefräser BSP - Innengewinde Thread milling cutter BSP - internal thread	mittellang mit Innen- kühlung medium length with through tool coolant	15°		357
AFT - Gewindefräser NPT-Innengewinde / Thread milling cutter NPT-internal thread						
AFT525.1-NPT...IK-F	3 - 4	Gewindefräser NPT - Innengewinde Thread milling cutter NPT - internal thread	kurz mit Innenkühlung und Fase short with through tool coolant and chamfers	15°		358

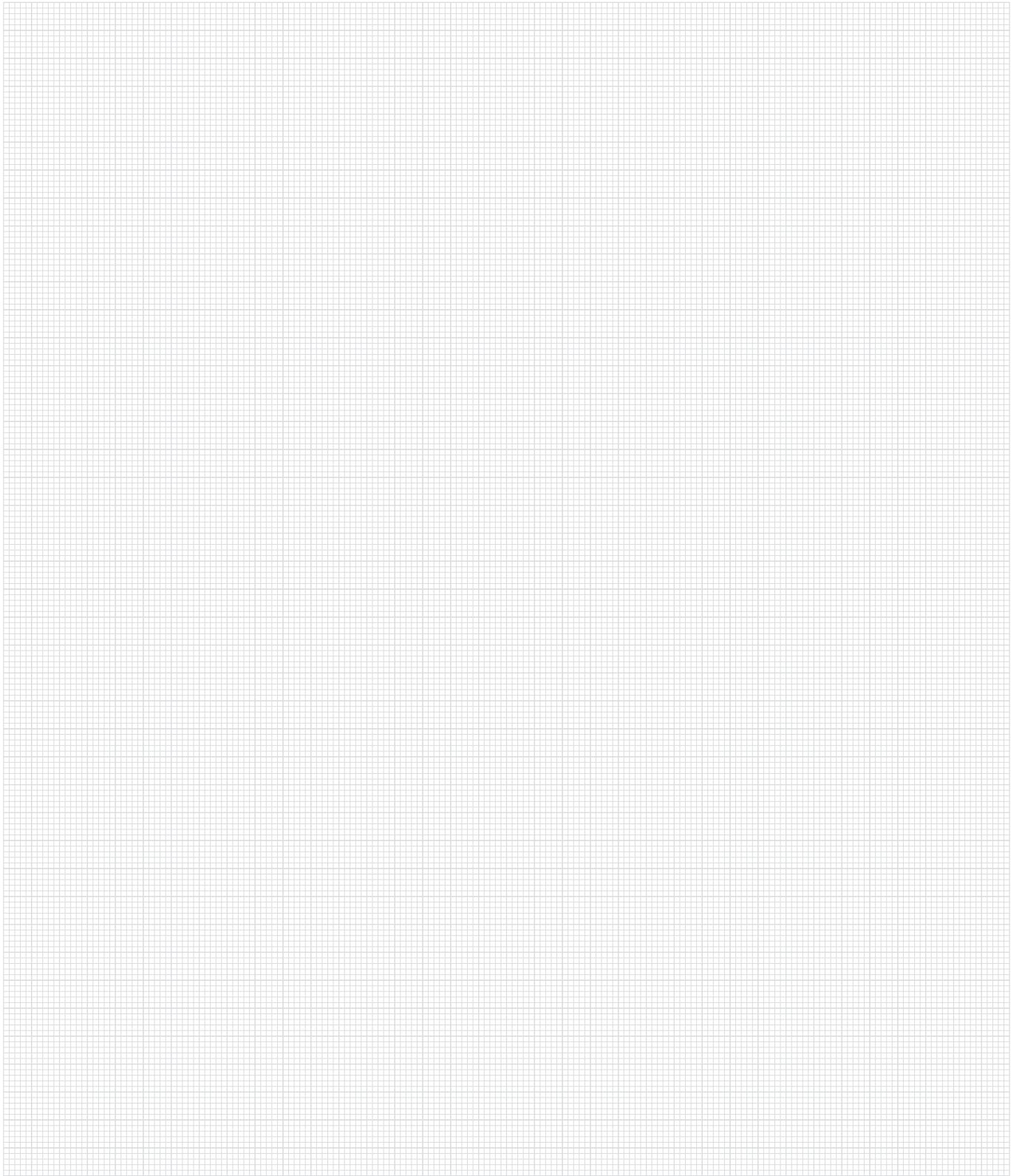

ARNO[®]
WERKZEUGE

Weitere Informationen finden Sie unter:
For more information see:

www.arno.de

ARNO[®]

WERKZEUGE

We have a passion for precision.

AUSFÜHRUNG AFT

Design AFT

**Rundum überzeugend:
ARNO-Gewindefräser aus Vollhartmetall für die
Bearbeitung von Stahl, Aluminium und NE-Metallen.**

**Solid carbide thread mills for
steel, aluminium and non-ferrous materials.**

TiAlN beschichtete Gewindefräser aus Feinstkorn-Hartmetall bieten Ihnen eine optimale, gleichmäßige Gewindegüte sowie eine hohe Verschleißfestigkeit.



Fine grain solid carbide cutters with TiAlN coating, some with through tool coolant and chamfering edge.

Gewindefräser ISO-Innengewinde

3 - 5 Schneiden, 15° Rechtsspirale, mittellange Ausführung

Thread milling cutter ISO-internal thread

3 - 5 flutes, 15 degree helix angle, mid-length design

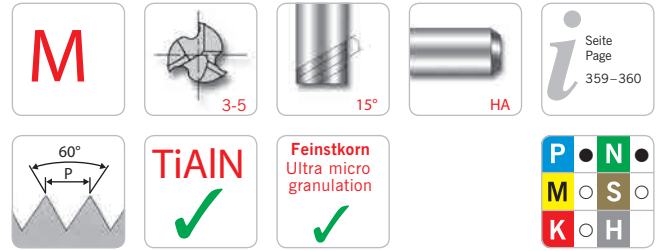

AFT525.1-ISO-...

Schaft / Shank DIN 6535HA	G Gewinde Thread	P Steigung Pitch	d	d _A	l ₁	l	z
AFT52531-ISO-M3X0.5	M3	0,5	2,20	6	5,00	57	3
AFT52531-ISO-M4X0.7	M4	0,7	2,90	6	7,00	57	3
AFT52531-ISO-M5X0.8	M5	0,8	3,80	6	8,00	57	3
AFT52531-ISO-M6X1.0	M6	1,00	4,50	6	13,00	57	3
AFT52531-ISO-M8X1.25	M8	1,25	6,00	6	17,50	65	3
AFT52541-ISO-M10X1.5	M10	1,5	7,50	8	21,00	72	4
AFT52541-ISO-M12X1.75	M12	1,75	9,50	10	26,25	80	4
AFT52541-ISO-M14X2.0	M14	2,00	10,00	10	30,00	83	4
AFT52541-ISO-M16X2.0	M16	2,00	12,00	12	34,00	92	4
AFT52551-ISO-M18X2.5	M18	2,5	14,00	14	37,50	92	5
AFT52551-ISO-M20X2.5	M20	2,5	16,00	16	42,50	105	5

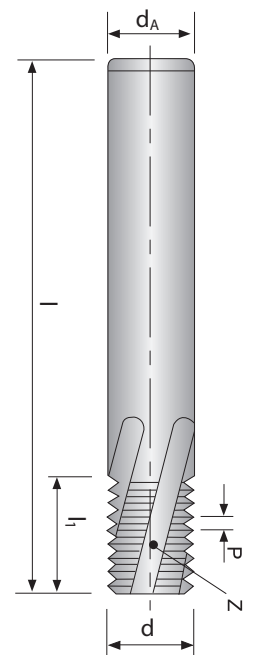

Gewindefräser ISO-Innengewinde

3 - 5 Schneiden, 15° Rechtsspirale, mittellange Ausführung



Thread milling cutter ISO-internal thread

3 - 5 flutes, 15 degree helix angle, mid-length design

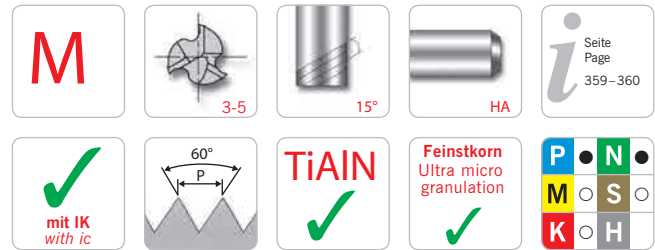

AFT525.1-ISO-...IK

Schaft / Shank DIN 6535HA	G Gewinde Thread	P Steigung Pitch	d	d _A	l ₁	l	z
AFT52531-ISO-M6X1.0IK	M6	1,0	4,50	6	13,00	57	3
AFT52531-ISO-M8X1.25IK	M8	1,25	6,00	6	17,50	65	3
AFT52541-ISO-M10X1.5IK	M10	1,5	7,50	8	21,00	72	4
AFT52541-ISO-M12X1.75IK	M12	1,75	9,50	10	26,25	80	4
AFT52541-ISO-M14X2.0IK	M14	2,00	10,00	10	30,00	83	4
AFT52541-ISO-M16X2.0IK	M16	2,00	12,00	12	34,00	92	4
AFT52551-ISO-M20X2.5IK	M20	2,5	16,00	16	42,50	105	5

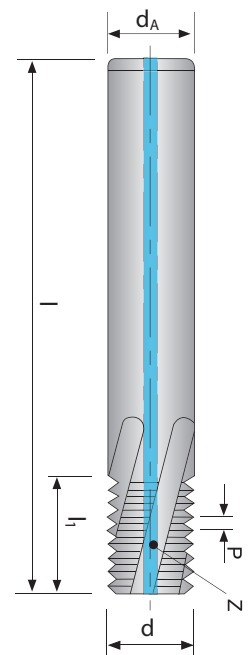

● = Hauptanwendung / Main application
○ = Nebenanwendung / Suitable

Dimensions in mm

Gewindefräser ISO-Innengewinde

3 - 4 Schneiden, 15° Rechtsspirale, mittellange Ausführung



Thread milling cutter ISO-internal thread

3 - 4 flutes, 15 degree helix angle, mid-length design

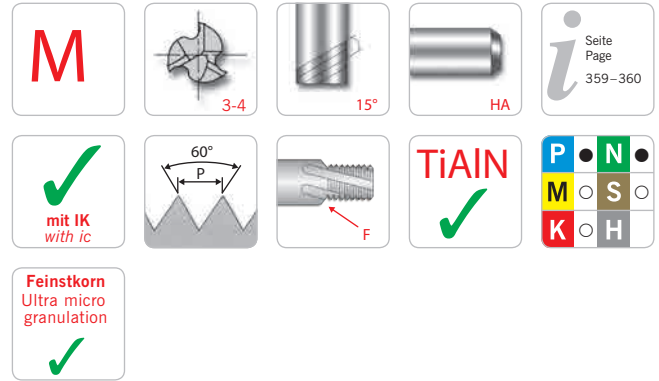

AFT525.1-ISO-...IK-F

Schaft / Shank DIN 6535HA	G Gewinde Thread	P Steigung Pitch	d	d _A	l ₁	l	A	z
AFT52531-ISO-M6X1.0IK-F	M6	1,00	4,80	8	12,40	62	90°	3
AFT52531-ISO-M8X1.25IK-F	M8	1,25	6,50	10	16,80	74	90°	3
AFT52541-ISO-M10X1.5IK-F	M10	1,5	8,20	12	20,15	80	90°	4
AFT52541-ISO-M12X1.75IK-F	M12	1,75	9,90	14	25,25	90	90°	4
AFT52541-ISO-M14X2.0IK-F	M14	2,00	11,60	16	28,85	100	90°	4
AFT52541-ISO-M16X2.0IK-F	M16	2,00	13,60	18	32,85	102	90°	4

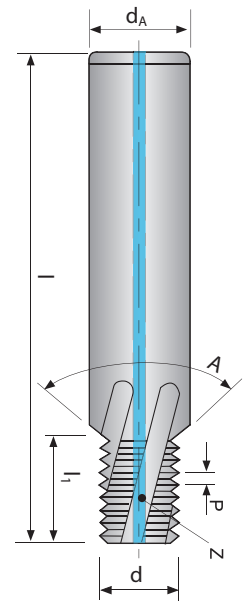

Gewindefräser ISO-Innengewinde

3 - 5 Schneiden, 15° Rechtsspirale, kurze Ausführung

Thread milling cutter ISO-internal thread

3 - 5 flutes, 15 degree helix angle, short design

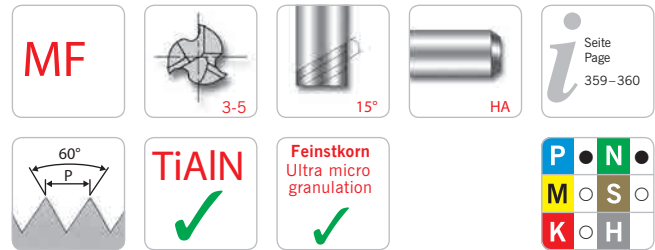

AFT525.0-ISO-...

Schaft / Shank DIN 6535HA	G Gewinde Thread	P Steigung Pitch	d	d _A	l ₁	l	z
AFT52530-ISO-M8X0.75	M8	0,75	6,00	6	12,75	57	3
AFT52530-ISO-M8X1.0	M8	1,00	6,00	6	13,00	57	3
AFT52540-ISO-M10X1.0	M10	1,00	8,00	8	16,00	63	4
AFT52540-ISO-M12X1.0	M12	1,00	9,50	10	19,00	72	4
AFT52540-ISO-M12X1.25	M12	1,25	9,50	10	18,75	72	4
AFT52540-ISO-M12X1.5	M12	1,5	9,50	10	19,50	72	4
AFT52540-ISO-M14X1.0	M14	1,00	10,00	10	22,00	83	4
AFT52540-ISO-M14X1.5	M14	1,5	10,00	10	22,50	83	4
AFT52540-ISO-M16X1.0	M16	1,00	12,00	12	25,00	83	4
AFT52540-ISO-M16X1.5	M16	1,5	12,00	12	25,50	83	4
AFT52550-ISO-M18X1.0	M18	1,00	14,00	14	28,00	92	5
AFT52550-ISO-M18X1.5	M18	1,5	14,00	14	28,50	92	5
AFT52550-ISO-M20X1.0	M20	1,00	16,00	16	31,00	92	5
AFT52550-ISO-M20X1.5	M20	1,5	16,00	16	31,50	92	5

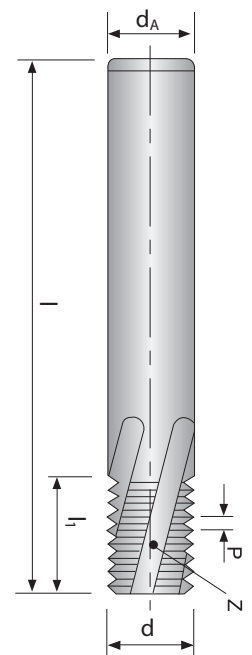

● = Hauptanwendung / Main application
○ = Nebenanwendung / Suitable

Dimensions in mm

Gewindefräser ISO-Innengewinde

3 - 5 Schneiden, 15° Rechtsspirale, kurze Ausführung

Thread milling cutter ISO-internal thread

3 - 5 flutes, 15 degree helix angle, short design

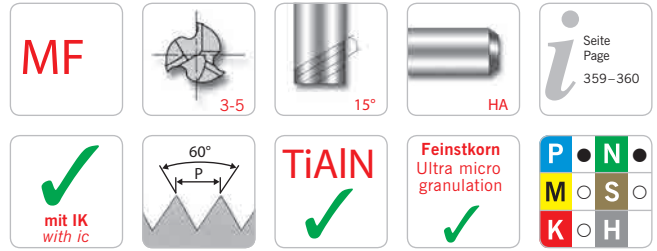

AFT525.0-ISO-...IK

Schaft / Shank DIN 6535HA	G Gewinde Thread	P Steigung Pitch	d	d _A	l ₁	l	z
AFT52530-ISO-M8X0.75IK	M8	0,75	6,00	6	12,75	57	3
AFT52530-ISO-M8X1.0IK	M8	1,00	6,00	6	13,00	57	3
AFT52540-ISO-M10X1.0IK	M10	1,00	8,00	8	16,00	63	4
AFT52540-ISO-M12X1.0IK	M12	1,00	9,50	10	19,00	72	4
AFT52540-ISO-M12X1.25IK	M12	1,25	9,50	10	18,75	72	4
AFT52540-ISO-M12X1.5IK	M12	1,5	9,50	10	19,50	72	4
AFT52540-ISO-M14X1.0IK	M14	1,00	10,00	10	22,00	83	4
AFT52540-ISO-M14X1.5IK	M14	1,5	10,00	10	22,50	83	4
AFT52540-ISO-M16X1.0IK	M16	1,00	12,00	12	25,00	83	4
AFT52540-ISO-M16X1.5IK	M16	1,5	12,00	12	25,50	83	4
AFT52550-ISO-M18X1.0IK	M18	1,00	14,00	14	28,00	92	5
AFT52550-ISO-M18X1.5IK	M18	1,5	14,00	14	28,50	92	5
AFT52550-ISO-M20X1.0IK	M20	1,00	16,00	16	31,00	92	5
AFT52550-ISO-M20X1.5IK	M20	1,5	16,00	16	31,50	92	5

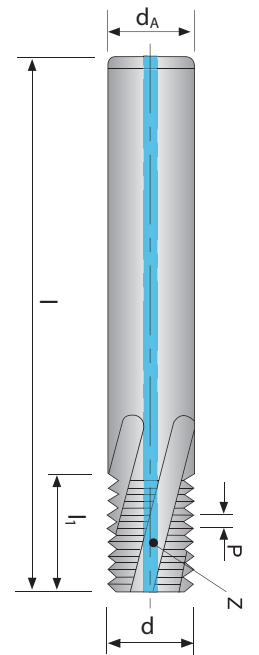

Gewindefräser ISO-Innengewinde

3 - 5 Schneiden, 15° Rechtsspirale, kurze Ausführung



Thread milling cutter ISO-internal thread

3 - 5 flutes, 15 degree helix angle, short design

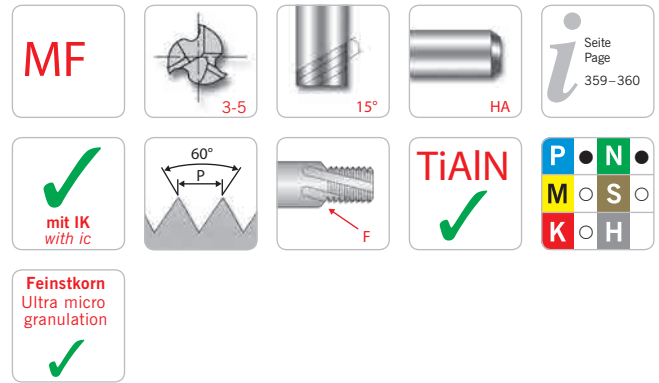

AFT525.0-ISO-...IK-F

Schaft / Shank DIN 6535HA	G Gewinde Thread	P Steigung Pitch	d	d _A	l ₁	l	A	z
AFT52530-ISO-M8X1.0IK-F	M8	1,00	6,70	10	12,40	74	90°	3
AFT52540-ISO-M10X1.0IK-F	M10	1,00	8,70	12	15,40	80	90°	4
AFT52540-ISO-M10X1.25IK-F	M10	1,25	8,30	12	15,90	80	90°	4
AFT52540-ISO-M12X1.0IK-F	M12	1,00	10,70	14	18,40	90	90°	4
AFT52540-ISO-M12X1.25IK-F	M12	1,25	10,30	14	18,30	80	90°	4
AFT52540-ISO-M12X1.5IK-F	M12	1,5	10,00	14	18,65	90	90°	4
AFT52540-ISO-M14X1.5IK-F	M14	1,5	12,00	16	21,65	100	90°	4
AFT52550-ISO-M16X1.5IK-F	M16	1,5	14,00	18	24,65	102	90°	5

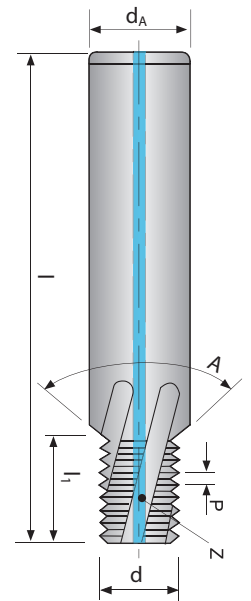

● = Hauptanwendung / Main application
○ = Nebenanwendung / Suitable

Dimensions in mm

Gewindfräser ISO-Innengewinde

3 Schneiden, 15° Rechtsspirale, Mini Ausführung



Thread milling cutter ISO-internal thread

3 flutes, 15 degree helix angle, mini design

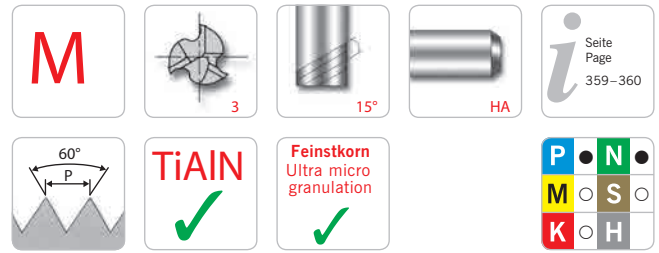

AFT52534-ISO-...

Schaft / Shank DIN 6535HA	G Gewinde Thread	P Steigung Pitch	d	d _A	l ₁	l ₂	l	z
AFT52534-ISO-M1.6X0.35	M1,6	0,35	1,18	3	1,05	3,40	30	3
AFT52534-ISO-M2X0.4	M2	0,4	1,52	6	1,20	4,20	57	3
AFT52534-ISO-M2.2X0.45	M2,2	0,45	1,66	6	1,35	4,60	57	3
AFT52534-ISO-M2.5X0.45	M2,5	0,45	1,96	6	1,35	5,30	57	3
AFT52534-ISO-M3X0.5	M3	0,5	2,40	6	1,50	6,30	57	3
AFT52534-ISO-M4X0.7	M4	0,7	3,16	6	2,10	8,40	57	3
AFT52534-ISO-M5X0.8	M5	0,8	4,04	6	2,40	10,50	57	3
AFT52534-ISO-M6X1.0	M6	1,0	4,80	6	3,00	12,60	57	3
AFT52534-ISO-M8X1.25	M8	1,25	6,50	8	3,75	16,80	63	3
AFT52534-ISO-M10X1.5	M10	1,5	8,20	10	4,50	21,00	73	3
AFT52534-ISO-M12X1.75	M12	1,75	9,90	10	5,25	25,20	73	3

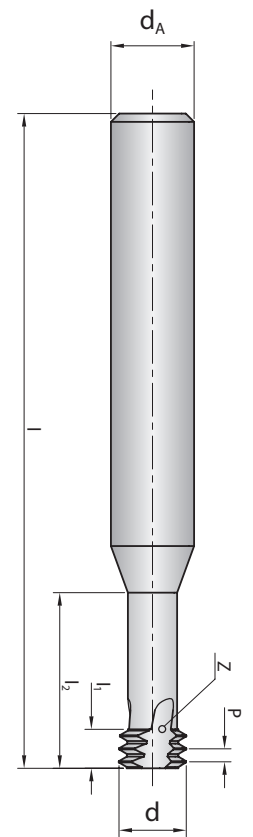

AFT

● = Hauptanwendung / Main application
○ = Nebenanwendung / Suitable

Bohren, Fasen und Gewindefräsen -Innengewinde

2 Schneiden, 15° Rechtsspirale, lange Ausführung

Drilling, countersinking and internal thread milling

2 flutes, 15 degree helix angle, long design



M

2
15°

15°

HA

i

Seite
Page
359-360

✓

mit IK
with ic

60°

F
140°

P	●	N	●
M	○	S	○
K	○	H	○

TiAlN

✓

Feinstkorn
Ultra micro
granulation

✓

AFT52621-ISO-...IK-F

Schaft / Shank DIN 6535HA	G Gewinde Thread	P Steigung Pitch	d	d _A	d ₁	d ₂	d ₃	l ₁	l ₂	l ₃	l ₄	l ₅	l
AFT52621-ISO-M6X1.0IK-F	M6	1,00	4,75	8	5,00	6,3	6,60	13,00	13,77	1,00	36	14,68	62
AFT52621-ISO-M8X1.25IK-F	M8	1,25	6,35	10	6,75	8,3	9,00	16,27	17,25	1,25	40	18,48	74
AFT52621-ISO-M10X1.5IK-F	M10	1,5	7,95	12	8,50	10,3	11,00	21,05	22,22	1,50	45	23,77	79
AFT52621-ISO-M12X1.75IK-F	M12	1,75	9,95	14	10,25	12,3	13,50	24,21	25,38	1,50	45	27,25	89
AFT52621-ISO-M14X2.0IK-F	M14	2,00	11,20	16	12,00	14,3	15,50	29,58	31,13	1,50	48	33,32	102

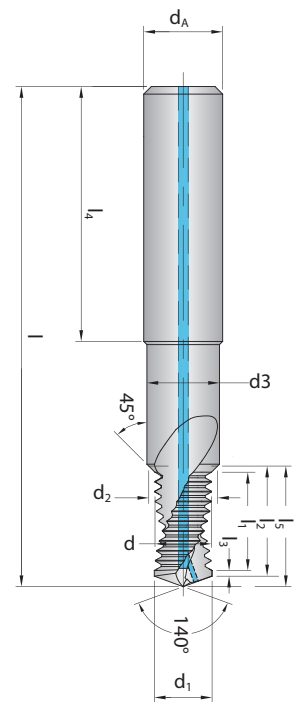

● = Hauptanwendung / Main application
○ = Nebenanwendung / Suitable

Dimensions in mm

Gewindefräser UNC-Innengewinde

3 - 5 Schneiden, 15° Rechtsspirale, mittellange Ausführung

Thread milling cutter UNC-internal thread

3 - 5 flutes, 15 degree helix angle, mid-length design

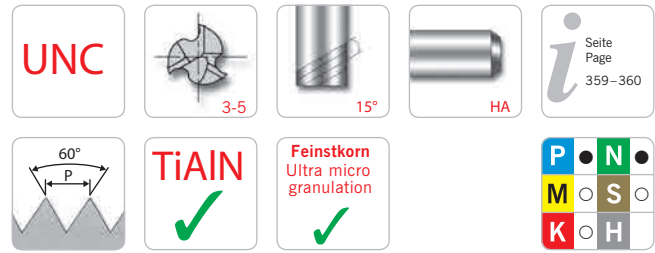

AFT525.1-UNC-...

Schaft / Shank DIN 6535HA	G Gewinde Thread	P Steigung Pitch	d	d _A	l ₁	l	z
AFT52531-UNC-1/4X20	1/4"	20,00	4,50	6	14,00	57	3
AFT52531-UNC-5/16X18	5/16"	18,00	5,80	6	16,90	65	3
AFT52541-UNC-3/8X16	3/8"	16,00	7,00	8	20,60	72	4
AFT52541-UNC-7/16X14	7/16"	14,00	8,00	8	23,60	72	4
AFT52541-UNC-1/2X13	1/2"	13,00	9,50	10	27,40	80	4
AFT52541-UNC-9/16X12	9/16"	12,00	10,00	10	31,80	83	4
AFT52541-UNC-5/8X11	5/8"	11,00	12,00	12	34,60	92	4
AFT52551-UNC-3/4X10	3/4"	10,00	14,00	14	40,60	104	5

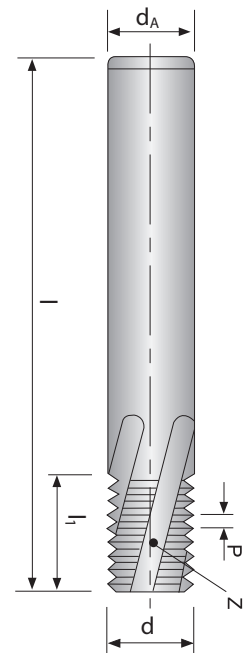

Gewindefräser UNC-Innengewinde

3 - 5 Schneiden, 15° Rechtsspirale, mittellange Ausführung



Thread milling cutter UNC-internal thread

3 - 5 flutes, 15 degree helix angle, mid-length design

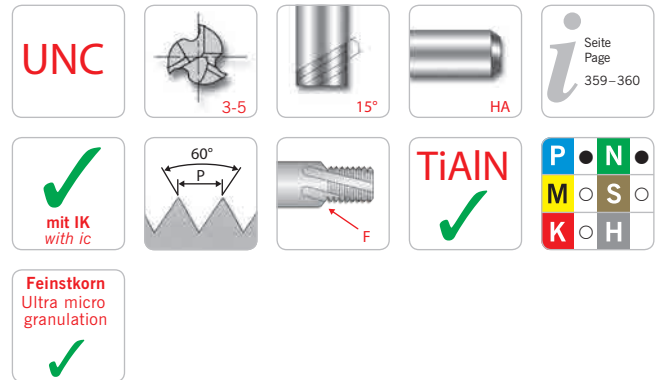

AFT525.1-UNC-...IK-F

Schaft / Shank DIN 6535HA	G Gewinde Thread	P Steigung Pitch	d	d _A	l ₁	l	A	z
AFT52531-UNC-1/4X20IK-F	1/4"	20,00	4,80	8	13,30	62	90°	3
AFT52531-UNC-5/16X18IK-F	5/16"	18,00	6,20	10	16,18	74	90°	3
AFT52541-UNC-3/8X16IK-F	3/8"	16,00	7,60	12	19,80	80	90°	4
AFT52541-UNC-7/16X14IK-F	7/16"	14,00	8,90	12	22,62	80	90°	4
AFT52541-UNC-1/2X13IK-F	1/2"	13,00	10,30	14	26,32	90	90°	4
AFT52541-UNC-9/16X12IK-F	9/16"	12,00	11,70	16	30,63	100	90°	4
AFT52541-UNC-5/8X11IK-F	5/8"	11,00	13,10	18	33,41	102	90°	4
AFT52551-UNC-3/4X10IK-F	3/4"	10,00	16,00	20	39,29	110	90°	5

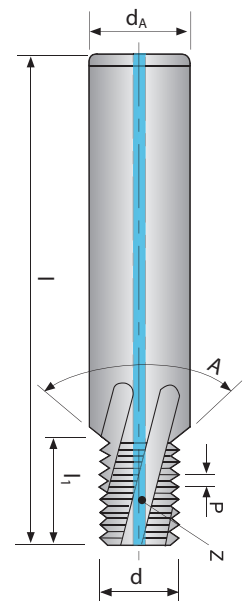

● = Hauptanwendung / Main application
○ = Nebenanwendung / Suitable

Dimensions in mm

Gewindefräser UNC-Innengewinde

3 Schneiden, 15° Rechtsspirale, Mini Ausführung



Thread milling cutter UNC-internal thread

3 flutes, 15 degree helix angle, mini design

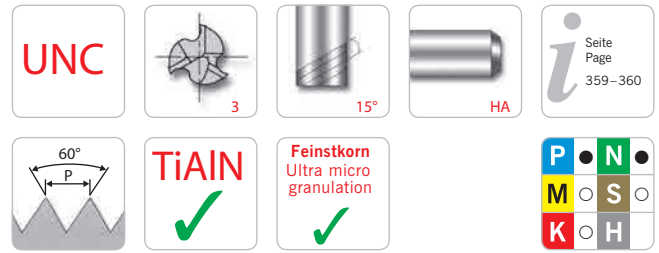

AFT52534-UNC-...

Schaft / Shank DIN 6535HA	G Gewinde Thread	P Steigung Pitch	d	d _A	l ₁	l ₂	l	z
AFT52534-UNC-1X64	1,00	64,00	1,38	6	1,19	3,90	57	3
AFT52534-UNC-2X56	2,00	56,00	1,64	6	1,36	4,60	57	3
AFT52534-UNC-4X40	4,00	40,00	2,08	6	1,91	6,00	57	3
AFT52534-UNC-6X32	6,00	32,00	2,55	6	2,38	7,40	57	3
AFT52534-UNC-8X32	8,00	32,00	3,21	6	2,38	8,70	57	3
AFT52534-UNC-10X24	10,00	24,00	3,56	6	3,18	10,10	57	3
AFT52534-UNC-12X24	12,00	24,00	4,22	6	3,18	11,50	57	3
AFT52534-UNC-1/4X20	1/4"	20,00	4,83	6	3,81	13,30	57	3
AFT52534-UNC-5/16X18	5/16"	18,00	6,24	8	4,23	16,70	63	3
AFT52534-UNC-3/8X16	3/8"	16,00	7,62	8	4,76	20,00	63	3
AFT52534-UNC-7/16X14	7/16"	14,00	8,94	10	5,44	23,30	73	3

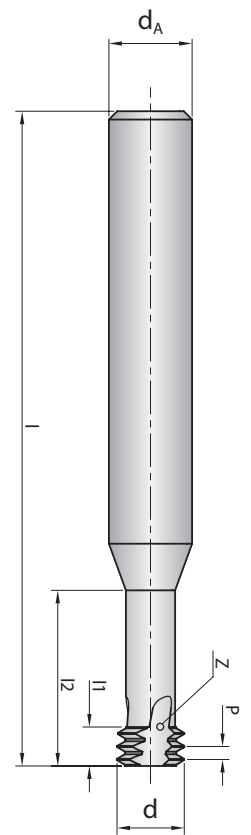

AFT

● = Hauptanwendung / Main application
○ = Nebenanwendung / Suitable

Gewindefräser UNF-Innengewinde

3 - 5 Schneiden, 15° Rechtsspirale, mittellange Ausführung

Thread milling cutter UNF-internal thread

3 - 5 flutes, 15 degree helix angle, mid-length design

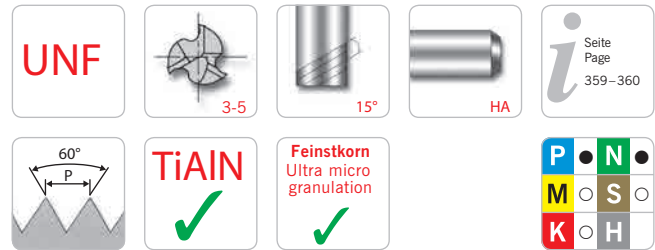

AFT525.1-UNF-...

Schaft / Shank DIN 6535HA	G Gewinde Thread	P Steigung Pitch	d	d _A	l ₁	l	z
AFT52531-UNF-1/4X28	1/4"	28,00	5,00	6	13,60	57	3
AFT52531-UNF-5/16X24	5/16"	24,00	6,00	6	16,90	65	3
AFT52541-UNF-3/8X24	3/8"	24,00	8,00	8	20,10	72	4
AFT52541-UNF-7/16X20	7/16"	20,00	8,00	8	24,10	72	4
AFT52541-UNF-1/2X20	1/2"	20,00	10,00	10	26,70	80	4
AFT52541-UNF-9/16X18	9/16"	18,00	12,00	12	29,60	83	4
AFT52541-UNF-5/8X18	5/8"	18,00	12,00	12	33,90	92	4
AFT52551-UNF-3/4X16	3/4"	16,00	14,00	14	39,70	104	5

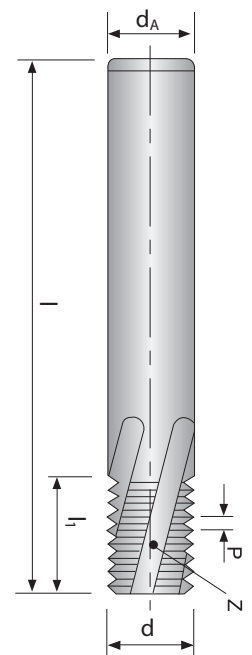

● = Hauptanwendung / Main application
○ = Nebenanwendung / Suitable

Dimensions in mm

Gewindefräser UNF-Innengewinde

3 - 5 Schneiden, 15° Rechtsspirale, mittellange Ausführung

Thread milling cutter UNF-internal thread

3 - 5 flutes, 15 degree helix angle, mid-length design



UNF

3-5

15°

HA

TiAlN

mit IK
with ic

60°

F

Feinstkorn
Ultra micro
granulation

AFT525.1-UNF-...IK-F

Schaft / Shank DIN 6535HA	G Gewinde Thread	P Steigung Pitch	d	d _A	l ₁	l	A	z
AFT52531-UNF-1/4X28IK-F	1/4"	28,00	5,10	8	13,21	62	90°	3
AFT52531-UNF-5/16X24IK-F	5/16"	24,00	6,50	10	16,37	74	90°	3
AFT52541-UNF-3/8X24IK-F	3/8"	24,00	8,10	12	19,54	80	90°	4
AFT52541-UNF-7/16X20IK-F	7/16"	20,00	9,40	12	22,19	80	90°	4
AFT52541-UNF-1/2X20IK-F	1/2"	20,00	11,00	14	26,00	90	90°	4
AFT52541-UNF-9/16X18IK-F	9/16"	18,00	12,40	16	28,88	100	90°	4
AFT52551-UNF-5/8X18IK-F	5/8"	18,00	14,00	18	33,12	102	90°	5
AFT52551-UNF-3/4X16IK-F	3/4"	16,00	17,00	20	38,86	110	90°	5

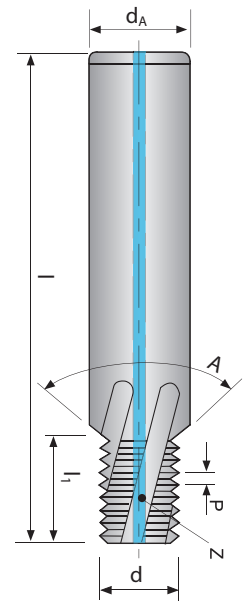

AFT

● = Hauptanwendung / Main application
○ = Nebenanwendung / Suitable

Gewindefräser BSP(G)-Innengewinde

3 - 5 Schneiden, 15° Rechtsspirale, mittellange Ausführung

Thread milling cutter BSP(G)-internal thread

3 - 5 flutes, 15 degree helix angle, mid-length design



BSP

3-5

15°

HA

i Seite
Page
359-360

✓
mit **IK**
with **ic**

55°

TiAlN

✓

Feinstkorn
Ultra micro
granulation

✓

P	●	N	●
M	○	S	○
K	○	H	○

AFT525.1-BSP-...IK

Schaft / Shank DIN 6535HA	G Gewinde Thread	P Steigung Pitch	d	d _A	l ₁	l	z
AFT52531-BSP-1/16X28IK	1/16"	28,00	5,90	6	16,30	65	3
AFT52541-BSP-1/8X28IK	1/8"	28,00	7,90	8	20,00	70	4
AFT52541-BSP-1/4X19IK	1/4"	19,00	9,90	10	26,70	80	4
AFT52541-BSP-3/8X19IK	3/8"	19,00	13,90	14	33,40	92	4
AFT52551-BSP-1/2X14IK	1/2"	14,00	15,90	16	43,50	104	5
AFT52551-BSP-3/4X14IK	3/4"	14,00	17,90	18	34,50	100	5
AFT52551-BSP-1X11IK	1"	11,00	19,90	20	34,60	100	5

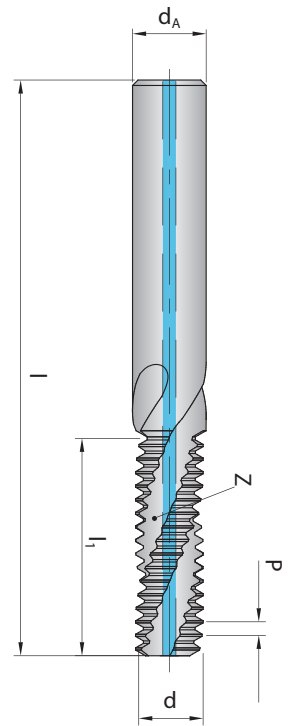

● = Hauptanwendung / Main application
○ = Nebenanwendung / Suitable

Dimensions in mm



Gewindefräser NPT-Innengewinde

3 - 4 Schneiden, 15° Rechtsspirale, kurze Ausführung

Thread milling cutter NPT-internal thread

3 - 4 flutes, 15 degree helix angle, short design



NPT

3-4

15°

HA

i

Seite
Page
359-360

✓

mit IK
with ic

60°

F

TiAlN

✓

P	●	N	●
M	○	S	○
K	○	H	○

Feinstkorn
Ultra micro
granulation

✓

AFT525.1-NPT-...IK-F

Schaft / Shank DIN 6535HA	G Gewinde Thread	P Steigung Pitch	d	d _A	l ₁	l	A	z
AFT52531-NPT-1/16X27IK-F	1/16"	27,00	5,90	10	8,90	64	90°	3
AFT52541-NPT-1/8X27IK-F	1/8"	27,00	7,80	12	8,90	70	90°	4
AFT52541-NPT-1/4X18IK-F	1/4"	18,00	10,05	16	13,40	81	90°	4
AFT52541-NPT-3/8X18IK-F	3/8"	18,00	13,45	18	13,40	81	90°	4

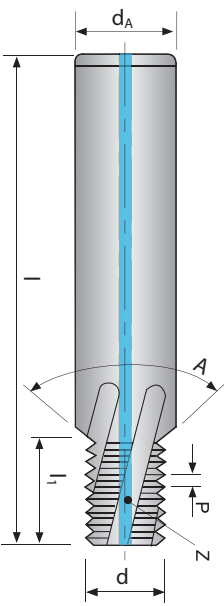

AFT

● = Hauptanwendung / Main application
○ = Nebenanwendung / Suitable

Dimensions in mm

Empfohlene Schnittwerte Gewindefräser

Ausführung AFT

ISO	Werkstoff	Festigkeit [N/mm ²]	V _c [m/min]	Durchmesser	
				3 - 10 mm	12 - 20 mm
P	Allgemeiner Baustahl	< 800	80 - 100	0,03 - 0,05	0,04 - 0,06
	Automatenstahl	< 800	80 - 100	0,03 - 0,05	0,04 - 0,06
	Einsatzstahl, unlegiert	< 800			
	Einsatzstahl, legiert	< 1000	40 - 60	0,01 - 0,02	0,02 - 0,04
	Vergütungsstahl, unlegiert	< 850			
	Vergütungsstahl, unlegiert	< 1000			
	Vergütungsstahl, legiert	< 800			
	Vergütungsstahl, legiert	< 1300			
	Stahlguss	< 850			
	Nitrierstahl	< 1000			
	Nitrierstahl	< 1200			
	Wälzlagerstahl	< 1200	40 - 60	0,01 - 0,02	0,02 - 0,04
	Federstahl	< 1200			
	Schnellarbeitsstahl	< 1300			
	Werkzeugstahl für Kaltarbeit	< 1300			
Werkzeugstahl für Warmarbeit	< 1300				
M	Stahl und Stahlguss, rostfrei geschwefelt	< 850			
	Nichtrostender Stahl, ferritisch	< 750			
	Nichtrostender Stahl, martensitisch	< 900			
	Nichtrostender Stahl, ferritisch/martensitisch	< 1100			
	Nichtrostender Stahl, austenitisch/ferritisch	< 850			
	Nichtrostender Stahl, austenitisch	< 750	80 - 120	0,04 - 0,06	0,06 - 0,08
K	Hitzebeständig	< 1100	80 - 120	0,04 - 0,06	0,06 - 0,08
	Grauguss mit Lammellengraphit	100 - 350			
	Grauguss mit Lammellengraphit	300 - 1000	150 - 200	0,06 - 0,10	0,08 - 0,15
	Kugelgraphitguss	300 - 500	100 - 150	0,04 - 0,06	0,06 - 0,08
	Kugelgraphitguss	550 - 800			
	Temperguss, weiß	350 - 450			
	Temperguss, weiß	500 - 650			
	Temperguss, schwarz	350 - 450			
Temperguss, schwarz	500 - 700				
N	Aluminium (unlegiert, niedrig legiert)	< 350	275 - 300	0,06 - 0,08	0,08 - 0,10
	Aluminiumlegierungen < 0,5% Si	< 500			
	Aluminiumlegierungen 0,5 - 10% Si	< 400			
	Aluminiumlegierungen 10 - 15% Si	< 400			
	Aluminiumlegierungen > 15% Si	< 400	180 - 200	0,03 - 0,04	0,04 - 0,05
	Kupfer (unlegiert, niedrig legiert)	< 350	275 - 300	0,06 - 0,08	0,08 - 0,10
	Kupfer-Knetlegierungen	< 700			
	Kupfer-Sonderlegierungen	< 200 HB			
	Kupfer-Sonderlegierungen	< 300 HB			
	Kupfer-Sonderlegierungen	> 300 HB			
	Messing kurzspanend, Bronze, Rotguss	< 600	275 - 300	0,06 - 0,08	0,08 - 0,10
	Messing langspanend	< 600			
	Thermoplaste		350 - 450	0,10 - 0,12	0,12 - 0,15
	Duroplaste		300 - 400	0,10 - 0,12	0,12 - 0,15
	Faserverstärkte Kunststoffe		180 - 200	0,03 - 0,04	0,04 - 0,05
	Magnesium und Magnesiumlegierungen	< 850			
S	Graphit				
	Wolfram und Wolframlegierungen				
	Molybdän und Molybdänlegierungen				
	Reinnickel				
	Nickellegierungen				
	Nickellegierungen	< 850	60 - 80	0,02 - 0,04	0,04 - 0,05
	Nickel-Chromlegierungen				
	Nickel- und Kobaltlegierungen	< 1300			
	Hochwarmfeste Legierungen	< 1300			
	Nickel-Kobalt-(Chrom-)legierungen	< 1400			
	Nickel- und Kobaltlegierungen	< 1300			
Reintitan	< 900				
Titanlegierungen	< 700				
Titanlegierungen	< 1200	50 - 80	0,01 - 0,03	0,02 - 0,05	
H	Stahl gehärtet	< 45 HRC			
		46 - 55 HRC			
		56 - 60 HRC			
		61 - 65 HRC			
		65 - 70 HRC			

Die Tabellenwerte sind Richtwerte. Es kann notwendig sein, die Werte den jeweiligen Bearbeitungsumständen anzupassen.

Recommended cutting data thread milling cutters

Design AFT

ISO	Material	Strength [N/mm ²]	V _c [m/min]	Diameter	
				3 - 10 mm	12 - 20 mm
P	General construction steel	< 800	80-100	0,03-0,05	0,04-0,06
	Free cutting steel	< 800	80-100	0,03-0,05	0,04-0,06
	Case hardened steel, non alloyed	< 800			
	Alloyed case hardened steel	< 1000	40-60	0,01-0,02	0,02-0,04
	Tempering steel, non alloyed	< 850			
	Tempering steel, non alloyed	< 1000			
	Tempering steel, alloyed	< 800			
	Tempering steel, alloyed	< 1300			
	Steel castings	< 850			
	Nitriding steel	< 1000			
	Nitriding steel	< 1200			
	Roller bearing steel	< 1200	40-60	0,01-0,02	0,02-0,04
	Spring steel	< 1200			
	High-speed steel	< 1300			
	Cold working tool steel	< 1300			
Hot working tool steel	< 1300				
M	Steel and sulphured cast stainless steel	< 850			
	Stainless steel, ferritic	< 750			
	Stainless steel, martensitic	< 900			
	Stainless steel, ferritic/martensitic	< 1100			
	Stainless steel, austenitic/ferritic	< 850			
	Stainless steel, austenitic	< 750	80-120	0,04-0,06	0,06-0,08
	Heat resistant steel	< 1100	80-120	0,04-0,06	0,06-0,08
K	Grey cast iron with lamellar graphite	100-350			
	Grey cast iron with lamellar graphite	300-1000	150-200	0,06-0,10	0,08-0,15
	Spheroidal cast iron	300-500	100-150	0,04-0,06	0,06-0,08
	Spheroidal cast iron	550-800			
	White cast iron, tempered	350-450			
	White cast iron, tempered	500-650			
	Black cast iron, tempered	350-450			
	Black cast iron, tempered	500-700			
N	Aluminium (non alloyed, low alloyed)	< 350	275-300	0,06-0,08	0,08-0,10
	Aluminium alloys < 0,5% Si	< 500			
	Aluminium alloys 0,5% - 10% Si	< 400			
	Aluminium alloys 10% - 15% Si	< 400			
	Aluminium alloys > 15% Si	< 400	180-200	0,03-0,04	0,04-0,05
	Copper (non alloyed, low alloyed)	< 350	275-300	0,06-0,08	0,08-0,10
	Copper wrought alloys	< 700			
	Special copper alloys	< 200 HB			
	Special copper alloys	< 300 HB			
	Special copper alloys	> 300 HB			
	Short-chipping brass, bronze, red bronze	< 600	275-300	0,06-0,08	0,08-0,10
	Long-chipping brass	< 600			
	Thermoplastics		350-450	0,10-0,12	0,12-0,15
	Duroplastics		300-400	0,10-0,12	0,12-0,15
	Fibre-reinforced plastics		180-200	0,03-0,04	0,04-0,05
	Magnesium and magnesium alloys	< 850			
	Graphite				
Tungsten and tungsten alloys					
Molybdenum and molybdenum alloys					
S	Pure nickel				
	Nickel alloys				
	Nickel alloys	< 850	60-80	0,02-0,04	0,04-0,05
	Nickel-chromium alloys				
	Nickel and cobalt alloys	< 1300			
	Nickel and cobalt alloys	< 1300			
	Heat resistant alloys	< 1400			
	Nickel-cobalt-chromium alloys	< 1300			
	Pure titanium	< 900			
	Titanium alloys	< 700			
Titanium alloys	< 1200	50-80	0,01-0,03	0,02-0,05	
H	Tempered steel	< 45 HRC			
		46-55 HRC			
		56-60 HRC			
		61-65 HRC			
		65-70 HRC			

The recommended cutting data are only approximate values. It may be necessary to adjust them to each individual machining application.

ARNO®

WERKZEUGE

We have a passion for precision.

MASCHINEN-GEWINDEBOHRER

Machine taps

Ausführung





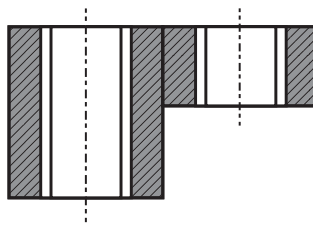

- AGT** - Metrisch ISO – Gerade Genutet
- Metrisch ISO – Spiralgenutet
- Metrisch ISO – Gerade Genutet –
Mit Innenkühlung
- Metrisch ISO – Spiralgenutet –
Mit Innenkühlung
- Metrisch ISO – Gerade Genutet –
Für rostfreie Stähle
- Metrisch ISO – Spiralgenutet –
Für rostfreie Stähle
- Metrisch ISO Fein – Gerade Genutet
- Metrisch ISO Fein – Spiralgenutet
- Metrisch ISO Fein – Gerade Genutet –
Für rostfreie Stähle
- Metrisch ISO Fein - Spiralgenutet –
Für rostfreie Stähle
- Amerikanisches Zollgewinde – Gerade Genutet
- Amerikanisches Zollgewinde – Spiralgenutet
- Amerikanisches Zollgewinde Fein – Gerade Genutet
- Amerikanisches Zollgewinde Fein – Spiralgenutet

Design





- AGT** - ISO metric coarse threads – Straight flute
- ISO metric coarse threads – Spiral flute
- ISO metric coarse threads – Straight flute –
With internal coolant
- ISO metric coarse threads – Spiral flute –
With internal coolant
- ISO metric coarse threads – Straight flute –
For stainless steels
- ISO metric coarse threads – Spiral flute –
For stainless steels
- ISO metric fine threads – Straight flute
- ISO metric fine threads – Spiral flute
- ISO metric fine threads – Straight flute –
For stainless steels
- ISO metric fine threads – Spiral flute –
For stainless steels
- Unified coarse threads – Straight flute
- Unified coarse threads – Spiral flute
- Unified fine threads – Straight flute
- Unified fine threads – Spiral flute



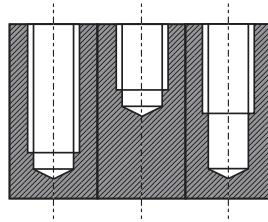

Bezeichnung Description		Gewinde Thread	Beschichtung Coating	Abb. Picture	Seite Page
AGT - gerade genutet - für Durchgangslöcher / straight flute - for through holes					
AGT72736-ISO-...	NEU NEW M	Metrisch ISO ISO metric coarse threads	TiN		368
AGT72742-ISO-... (IK)	NEU NEW M	Metrisch ISO – Mit Innenkühlung ISO metric coarse threads – with internal coolant	TiN		370
AGT72736-ISO-...-VA...	NEU NEW M	Metrisch ISO – Für rostfreie Stähle ISO metric coarse threads – For stainless steels	TiCN		372
AGT72737-ISO-...	NEU NEW MF	Metrisch ISO Fein ISO metric fine threads	TiN		374
AGT72737-ISO-...-VA...	NEU NEW MF	Metrisch ISO Fein – Für rostfreie Stähle ISO metric fine threads – For stainless steels	TiCN		376
AGT72739-UNC-...	NEU NEW UNC	Amerikanisches Zollgewinde Unified coarse threads	TiN		378
AGT72738-UNF-...	NEU NEW UNF	Amerikanisches Zollgewinde Fein Unified fine threads	TiN		380



Bezeichnung Description		Gewinde Thread	Beschichtung Coating	Abb. Picture	Seite Page
AGT - spiralgenutet - für Sacklöcher / spiral flute - for bottoming holes					
AGT72636-ISO-...	NEU NEW M	Metrisch ISO ISO metric coarse threads	TiN		369
AGT72642-ISO-... (IK)	NEU NEW M	Metrisch ISO – Mit Innenkühlung ISO metric coarse threads – with internal coolant	TiN		371
AGT72636-ISO-...-VA...	NEU NEW M	Metrisch ISO – Für rostfreie Stähle ISO metric coarse threads – For stainless steels	TiCN		373
AGT72637-ISO-...	NEU NEW MF	Metrisch ISO Fein ISO metric fine threads	TiN		375
AGT72637-ISO-...-VA...	NEU NEW MF	Metrisch ISO Fein – Für rostfreie Stähle ISO metric fine threads – For stainless steels	TiCN		377
AGT72639-UNC-...	NEU NEW UNC	Amerikanisches Zollgewinde Unified coarse threads	TiN		379
AGT72638-UNF-...	NEU NEW UNF	Amerikanisches Zollgewinde Fein Unified fine threads	TiN		381

Gewindearten / Threads

Metrisches ISO Gewinde nach DIN 13

ISO metric coarse threads acc. to DIN 13

Das metrische ISO-Regelgewinde ist ein weltweit standardisiertes Gewinde mit metrischen Abmessungen und 60° Flankenwinkel.

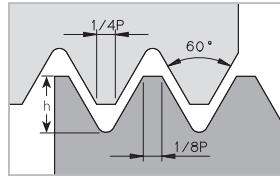

The metric ISO thread is a global standard thread in metric dimensions and 60° profile.

Metrisches ISO-Feingewinde nach DIN 13

Metric ISO-Fine-Thread acc. to DIN 13

Ein Feingewinde hat – im Vergleich zum Regelgewinde – ein engeres Gewindeprofil, was die Belastbarkeit erhöht. Eingesetzt wird es z. B. bei Stellschrauben an Messgeräten. Der Flankenwinkel beträgt 60°.

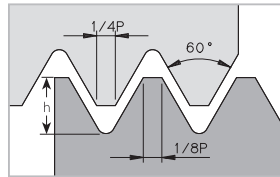

The ISO fine thread has a different pitch to the coarse thread, the profile is 60°.

Amerikanisches Zoll-Grob-Gewinde nach ANSI B1.1

American Unified-National-Coarse-Thread acc. to ANSI B1.1

Amerikanisches Einheits-Grobgewinde. Der Flankenwinkel beträgt 60°. Die UNC-Gewindenorm ist überwiegend in den Vereinigten Staaten und Kanada gebräuchlich. Der Durchmesser wird in Zoll angegeben. Die Gewindesteigung in Umdrehungen pro Zoll.

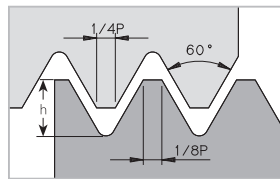

The American version of the ISO thread, the profile is 60° however the dimensions are all in inch and the pitch is listed as thread per inch.

Amerikanisches Zoll-Fein-Gewinde nach ANSI B1.1

American Unified-National-Fine-Thread acc. to ANSI B1.1

Amerikanisches Einheits-Feingewinde. Ausführung ähnlich wie UNC, jedoch mit einer kleineren Steigung. Der Flankenwinkel beträgt 60°. UNF Gewinde werden z. B. in der Luft- und Raumfahrt verwendet

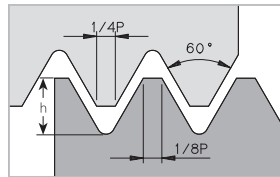

The fine pitch version of the UNC thread form, 60° profile but with more threads per inch.

Allgemeine Informationen

Maschinengewindebohrer

Gerade Genutet FORM B / Straight flutes Form B

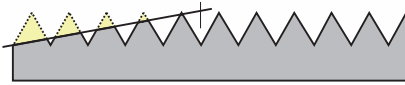

Information

Machine taps

- **Gerade Spanform mit Schälanschnitt**
Straight flutes with spiral point
- **Anschnitt 4–5 Gänge**
Chamfer 4–5 threads
- **Für Durchgangslöcher**
For through hole threads

Für Durchgangslöcher in langspanenden Materialien. Die Späne werden nach vorne geschoben und ein Verstopfen der Spannuten wird verhindert. Nicht im Umkehrschnitt einsetzen!

For through hole threads in long-chipping material. The spiral point pushes the rolled chips ahead and prevents clogging of the flutes. Do not use this tap type for a reverse cut!

Spiral Genutet FORM C / Spiral flutes Form C



- **35–50° rechtsgedallte Spannuten**
35–50° right-hand spiral flutes
- **Anschnitt 2–3 Gänge**
Chamfer 2–3 threads
- **Für Sacklöcher**
For blind hole threads

Für Sacklochgewinde in langspanenden Werkstoffen. Durch die gedallten Nuten werden die Späne nach hinten aus der Bohrung herausgefördert. Nicht für Gewinde mit vorgesetzter Aufbohrung geeignet.

For blind hole threads in long-chipping materials. The spiral flutes provide good chip removal from the blind hole. Not to be recommended for threads beginning with an increased diameter.

Sortenbeschreibung / Grade description



Unbeschichtet
Gewindebohrer für die Bearbeitung von Gusswerkstoffen, Aluminium, Kupfer und Nichteisenwerkstoffen. Geeignet für kundenspezifische Beschichtungslösungen.

Uncoated
Taps suitable for cast materials, aluminium, copper and non-ferrous materials. Suitable for customer specific coatings.



TiN beschichtet
Titan-Nitrid
Im PVD-Verfahren erzeugte TiN Beschichtung. Schichtdicken von 1–4 µm. Die hohe Härte der Beschichtung und die guten Gleiteigenschaften sorgen für optimale Zerspanungsergebnisse. Die mehrlagige Beschichtung führt zu erheblichen Standzeiterhöhungen.

TiN coated
Titanium-nitride
PVD TiN coating with a coating thickness of 1–4 µm. The hardness of the coating and the low friction ensures optimum machining results and improved tool life.



TiCN beschichtet
Titan-Carbonitrid
Im PVD-Verfahren beschichtet. Es werden Schichtdicken von 2–4 µm erreicht. Die Härte beträgt ca. 3000 HV. Die TiCN-Schicht ist bis ca. 400 °C beständig.

TiCN coated
Titanium carbon nitride
PVD TiCN coating with a coating thickness of 2–4 µm. The hardness is approximately 3000 HV. The TiCN coating is resistant up to approximately 400 °C.

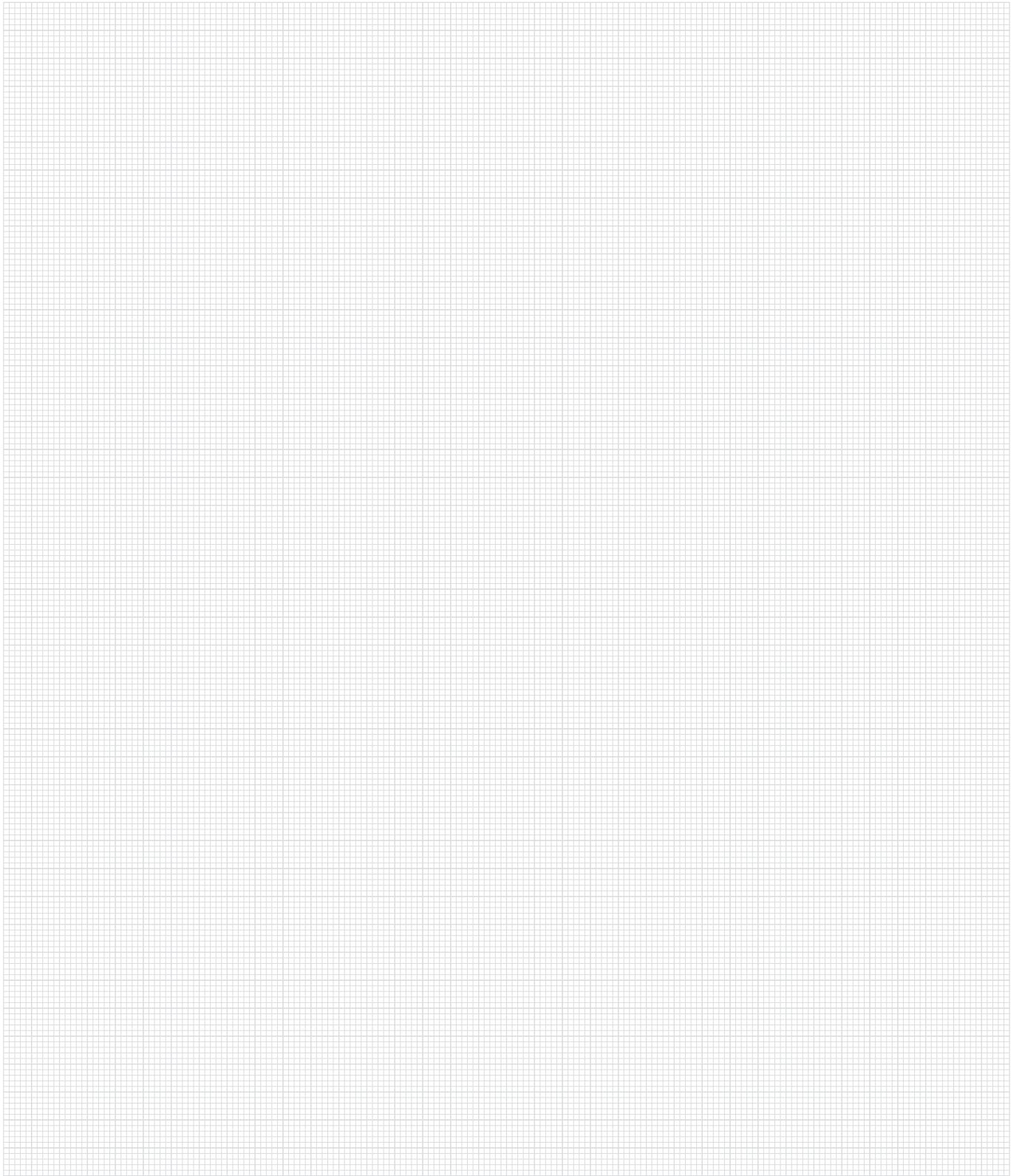

ARNO[®]
WERKZEUGE

Weitere Informationen finden Sie unter:
For more information see:

www.arno.de

ARNO®

WERKZEUGE

We have a passion for precision.

AUSFÜHRUNG AGT

Design AGT

Übersicht ARNO® Maschinen-Gewindebohrer.

Overview machine taps.

NEU
NEW

ARNO® Maschinengewindebohrer für metrische Gewinde (M), metrische Feingewinde (MF), UNC- und UNF Gewinde. In gerade genutet (Form B / Für Durchgangslöcher) und spiralgenutet (Form C / Für Grundlöcher) lieferbar. Ausführung nach DIN 371 / 376. Unbeschichtet, TiN oder TiCN beschichtet. Gewindebohrer für metrische Gewinde (M) auch mit Innenkühlung erhältlich.



ARNO® machine taps for metric threads (M), metric fine (MF), UNC and UNF threads. Available as straight fluted (form B for through holes) and spiral fluted (form C for blind holes) and made to DiN371/376 standard. The taps are available as uncoated, TiN and TiCN coated. Through tool coolant available for the metric (M) taps.

Maschinengewindebohrer

Metrisch ISO - Gerade genutet



N NEU/NEW

Machine tabs

ISO metric coarse threads - Straight flute

M

Form B

DIN
371/376

i

Seite
Page
382-391

Unbeschichtet
Uncoated

X

TiN

✓

6H

✓

P	N
M	S
K	H

HSS-E

✓

AGT72736-ISO-...

Schaft / Shank	G Gewinde Thread	P Steigung Pitch	l	l ₁	d _A	4-Kant Square	Kernloch ø / Tap drill size
AGT72736-ISO-M2X0.4 N	M2	0,4	45	8	2,8	2,10	1,60
AGT72736-ISO-M2.2X0.45 N	M2,2	0,45	45	8	2,8	2,10	1,75
AGT72736-ISO-M2.3X0.4 N	M2,3	0,4	45	8	2,8	2,10	1,90
AGT72736-ISO-M2.5X0.45 N	M2,5	0,45	50	9	2,8	2,10	2,05
AGT72736-ISO-M2.6X0.45 N	M2,6	0,45	50	9	2,8	2,10	2,10
AGT72736-ISO-M3X0.5 N	M3	0,5	56	11	3,5	2,70	2,50
AGT72736-ISO-M3.5X0.6 N	M3,5	0,6	56	12	4	3,00	2,90
AGT72736-ISO-M4X0.7 N	M4	0,7	63	13	4,5	3,40	3,30
AGT72736-ISO-M4.5X0.75 N	M4,5	0,75	70	14	6	4,90	3,70
AGT72736-ISO-M5X0.8 N	M5	0,8	70	15	6	4,90	4,20
AGT72736-ISO-M6X1.0 N	M6	1,00	80	17	6	4,90	5,00
AGT72736-ISO-M7X1.0 N	M7	1,00	80	17	7	5,50	6,00
AGT72736-ISO-M8X1.25 N	M8	1,25	90	20	8	6,20	6,80
AGT72736-ISO-M9X1.25 N	M9	1,25	90	20	9	7,00	7,80
AGT72736-ISO-M10X1.5 N	M10	1,5	100	22	10	8,00	8,50
AGT72736-ISO-M11X1.5 N	M11	1,5	100	22	8	6,20	9,50
AGT72736-ISO-M12X1.75 N	M12	1,75	110	24	9	7,00	10,20
AGT72736-ISO-M14X2.0 N	M14	2,00	110	26	11	9,00	12,00
AGT72736-ISO-M16X2.0 N	M16	2,00	110	27	12	9,00	14,00
AGT72736-ISO-M18X2.5 N	M18	2,5	125	30	14	11,00	15,50
AGT72736-ISO-M20X2.5 N	M20	2,5	140	32	16	12,00	17,50

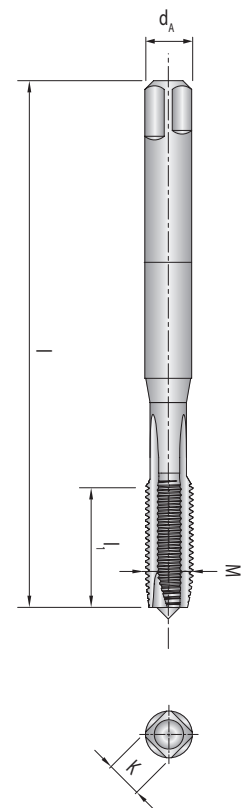

AGT

Passende VHM- oder PH-HSS Spiralbohrer finden Sie im Kapitel 14.
Suitable solid carbide or PM-HSS twist drills can be found in chapter 14.

● = Hauptanwendung / Main application
○ = Nebenanwendung / Suitable

Alle Angaben in mm / Dimensions in mm

Maschinengewindebohrer

Metrisch ISO - Spiralgenutet



Machine tabs

ISO metric coarse threads - Spiral flute

M		Form C	DIN 371/376	
	Unbeschichtet Uncoated X	TiN 	6H 	
HSS-E 				

AGT72636-ISO...

Schaft / Shank	G Gewinde Thread	P Steigung Pitch	l	l ₁	d _A	4-Kant Square	Kernloch ø / Tap drill size
AGT72636-ISO-M2X0.4 N	M2	0,4	45	8	2,8	2,10	1,60
AGT72636-ISO-M2.2X0.45 N	M2,2	0,45	45	8	2,8	2,10	1,75
AGT72636-ISO-M2.3X0.4 N	M2,3	0,4	45	8	2,8	2,10	1,90
AGT72636-ISO-M2.5X0.45 N	M2,5	0,45	50	9	2,8	2,10	2,05
AGT72636-ISO-M2.6X0.45 N	M2,6	0,45	50	9	2,8	2,10	2,10
AGT72636-ISO-M3X0.5 N	M3	0,5	56	6	3,5	2,70	2,50
AGT72636-ISO-M3.5X0.6 N	M3,5	0,6	56	7	4	3,00	2,90
AGT72636-ISO-M4X0.7 N	M4	0,7	63	7	4,5	3,40	3,30
AGT72636-ISO-M4.5X0.75 N	M4,5	0,75	70	8	6	4,90	3,70
AGT72636-ISO-M5X0.8 N	M5	0,8	70	8	6	4,90	4,20
AGT72636-ISO-M6X1.0 N	M6	1,00	80	10	6	4,90	5,00
AGT72636-ISO-M7X1.0 N	M7	1,00	80	10	7	5,50	6,00
AGT72636-ISO-M8X1.25 N	M8	1,25	90	13	8	6,20	6,80
AGT72636-ISO-M9X1.25 N	M9	1,25	90	13	9	7,00	7,80
AGT72636-ISO-M10X1.5 N	M10	1,5	100	15	10	8,00	8,50
AGT72636-ISO-M11X1.5 N	M11	1,5	100	17	8	6,20	9,50
AGT72636-ISO-M12X1.75 N	M12	1,75	110	18	9	7,00	10,20
AGT72636-ISO-M14X2.0 N	M14	2,00	110	20	11	9,00	12,00
AGT72636-ISO-M16X2.0 N	M16	2,00	110	20	12	9,00	14,00
AGT72636-ISO-M18X2.5 N	M18	2,5	125	25	14	11,00	15,50
AGT72636-ISO-M20X2.5 N	M20	2,5	140	25	16	12,00	17,50

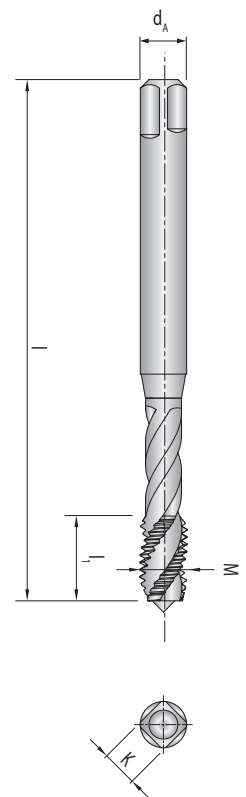

● = Hauptanwendung / Main application
○ = Nebenanwendung / Suitable

Alle Angaben in mm / Dimensions in mm

Maschinengewindebohrer

Metrisch ISO - Gerade Genutet - Mit Innenkühlung



Machine tabs

ISO metric coarse threads - Straight flute - With internal coolant

M

Form B

DIN
371/376

i
Seite
Page
382-391

✓
mit **IK**
with ic

Unbeschichtet
Uncoated
X

6H
✓

P	N
M	S
K	H

HSS-E
✓

AGT72742-ISO-... (IK)

Schaft / Shank	G Gewinde Thread	P Steigung Pitch	l	l ₁	d _A	4-Kant Square	Kernloch ø / Tap drill size
AGT72742-ISO-M6X1.0- IK	M6	1,00	80	17	6	4,90	5,00
AGT72742-ISO-M8X1.25- IK	M8	1,25	90	20	8	6,20	6,80
AGT72742-ISO-M10X1.5- IK	M10	1,5	100	22	10	8,00	8,50
AGT72742-ISO-M12X1.75- IK	M12	1,75	110	24	9	7,00	10,20
AGT72742-ISO-M14X2.0- IK	M14	2,00	110	26	11	9,00	12,00
AGT72742-ISO-M16X2.0- IK	M16	2,00	110	27	12	9,00	14,00
AGT72742-ISO-M18X2.5- IK	M18	2,5	125	30	14	11,00	15,50
AGT72742-ISO-M20X2.5- IK	M20	2,5	140	32	16	12,00	17,50

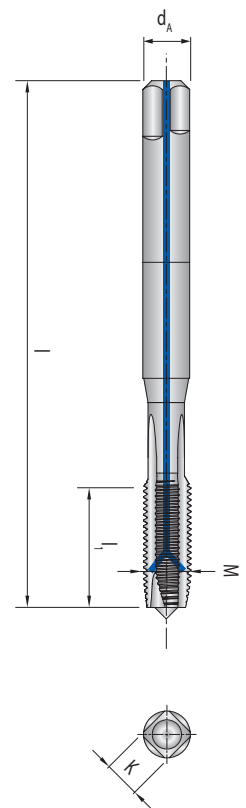

Maschinengewindebohrer

Metrisch ISO - Spiralgenutet - Mit Innenkühlung



Machine tabs

ISO metric coarse threads - Spiral flute - With internal coolant

M		Form C	DIN 371/376	
 mit IK with ic		Unbeschichtet X Uncoated	6H 	
 HSS-E				

AGT72642-ISO-... (IK)

Schaft / Shank	G Gewinde Thread	P Steigung Pitch	l	l ₁	d _A	4-Kant Square	Kernloch ø / Tap drill size
AGT72642-ISO-M6X1.0- IK	M6	1,00	80	10	6	4,90	5,00
AGT72642-ISO-M8X1.25- IK	M8	1,25	90	13	8	6,20	6,80
AGT72642-ISO-M10X1.5- IK	M10	1,5	100	15	10	8,00	8,50
AGT72642-ISO-M12X1.75- IK	M12	1,75	110	18	9	7,00	10,20
AGT72642-ISO-M14X2.0- IK	M14	2,00	110	20	11	9,00	12,00
AGT72642-ISO-M16X2.0- IK	M16	2,00	110	20	12	9,00	14,00
AGT72642-ISO-M18X2.5- IK	M18	2,5	125	25	14	11,00	15,50
AGT72642-ISO-M20X2.5- IK	M20	2,5	140	25	16	12,00	17,50

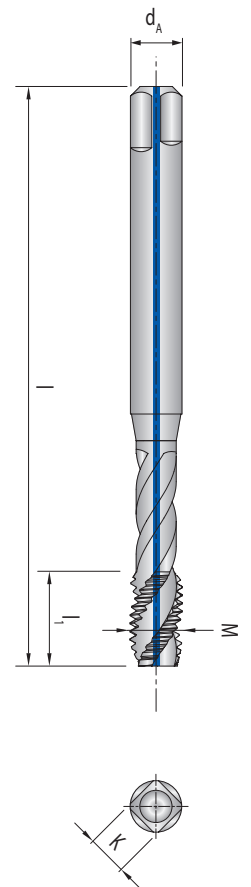

● = Hauptanwendung / Main application
○ = Nebenanwendung / Suitable

Alle Angaben in mm / Dimensions in mm

Maschinengewindebohrer

Metrisch ISO - Gerade Genutet - Für rostfreie Stähle



Machine tabs

ISO metric coarse threads - Straight flute - For stainless steels

M

Form B

DIN
371/376

i

Seite
Page
382-391

60°
P

TiCN

✓

6H

✓

PM-HSS

✓

P	N
M	S
K	H

VA

✓

AGT72736-ISO-...-VA...

Schaft / Shank	G Gewinde Thread	P Steigung Pitch	l	l ₁	d _A	4-Kant Square	Kernloch ø / Tap drill size
AGT72736-ISO-M2X0.4-VA N	M2	0,4	45	8	2,8	2,10	1,60
AGT72736-ISO-M2.2X0.45-VA N	M2,2	0,45	45	8	2,8	2,10	1,75
AGT72736-ISO-M2.3X0.4-VA N	M2,3	0,4	45	8	2,8	2,10	1,90
AGT72736-ISO-M2.5X0.45-VA N	M2,5	0,45	50	9	2,8	2,10	2,05
AGT72736-ISO-M2.6X0.45-VA N	M2,6	0,45	50	9	2,8	2,10	2,10
AGT72736-ISO-M3X0.5-VA N	M3	0,5	56	11	3,5	2,70	2,50
AGT72736-ISO-M3.5X0.6-VA N	M3,5	0,6	56	12	4	3,00	2,90
AGT72736-ISO-M4X0.7-VA N	M4	0,7	63	13	4,5	3,40	3,30
AGT72736-ISO-M4.5X0.75-VA N	M4,5	0,75	70	14	6	4,90	3,70
AGT72736-ISO-M5X0.8-VA N	M5	0,8	70	15	6	4,90	4,20
AGT72736-ISO-M6X1.0-VA N	M6	1,00	80	17	6	4,90	5,00
AGT72736-ISO-M7X1.0-VA N	M7	1,00	80	17	7	5,50	6,00
AGT72736-ISO-M8X1.25-VA N	M8	1,25	90	20	8	6,20	6,80
AGT72736-ISO-M9X1.25-VA N	M9	1,25	90	20	9	7,00	7,80
AGT72736-ISO-M10X1.5-VA N	M10	1,5	100	22	10	8,00	8,50
AGT72736-ISO-M11X1.5-VA N	M11	1,5	100	22	8	6,20	9,50
AGT72736-ISO-M12X1.75-VA N	M12	1,75	110	24	9	7,00	10,20

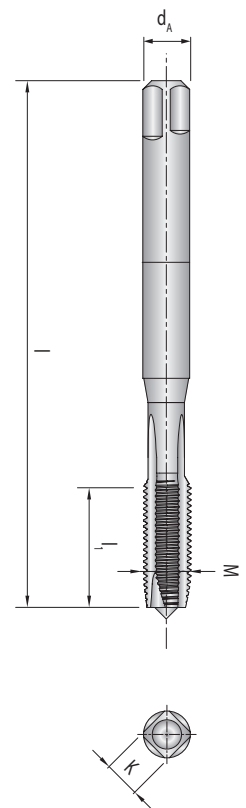

Maschinengewindebohrer

Metrisch ISO - Spiralgenutet - Für rostfreie Stähle



Machine tabs

ISO metric coarse threads - Spiral flute - For stainless steels

M

Form C

DIN
371/376

TiCN

✓

PM-HSS

✓

VA

✓

P	N
M	S
K	H

6H

✓

AGT72636-ISO-...-VA...

Schaft / Shank	G Gewinde Thread	l	l ₁	d _A	4-Kant Square	Kernloch ø / Tap drill size
AGT72636-ISO-M2X0.4-VA N	M2	45	8	2,8	2,10	1,60
AGT72636-ISO-M2.2X0.45-VA N	M2,2	45	8	2,8	2,10	1,75
AGT72636-ISO-M2.3X0.4-VA N	M2,3	45	8	2,8	2,10	1,90
AGT72636-ISO-M2.5X0.45-VA N	M2,5	50	9	2,8	2,10	2,05
AGT72636-ISO-M2.6X0.45-VA N	M2,6	50	9	2,8	2,10	2,10
AGT72636-ISO-M3X0.5-VA N	M3	56	6	3,5	2,70	2,50
AGT72636-ISO-M3.5X0.6-VA N	M3,5	56	7	4	3,00	2,90
AGT72636-ISO-M4X0.7-VA N	M4	63	7	4,5	3,40	3,30
AGT72636-ISO-M4.5X0.75-VA N	M4,5	70	8	6	4,90	3,70
AGT72636-ISO-M5X0.8-VA N	M5	70	8	6	4,90	4,20
AGT72636-ISO-M6X1.0-VA N	M6	80	10	6	4,90	5,00
AGT72636-ISO-M7X1.0-VA N	M7	80	10	7	5,50	6,00
AGT72636-ISO-M8X1.25-VA N	M8	90	13	8	6,20	6,80
AGT72636-ISO-M9X1.25-VA N	M9	90	13	9	7,00	7,80
AGT72636-ISO-M10X1.5-VA N	M10	100	15	10	8,00	8,50
AGT72636-ISO-M11X1.5-VA N	M11	100	17	8	6,20	9,50
AGT72636-ISO-M12X1.75-VA N	M12	110	18	9	7,00	10,20

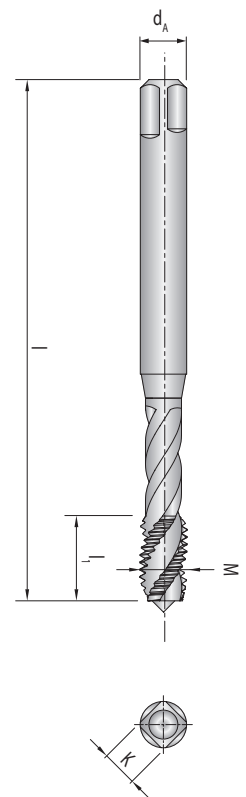

● = Hauptanwendung / Main application
○ = Nebenanwendung / Suitable

Alle Angaben in mm / Dimensions in mm

Maschinengewindebohrer

Metrisch ISO Fein - Gerade Genutet



Machine tabs

ISO metric fine threads - Straight flute

MF

Form B

DIN
371/376

i
Seite
Page
382-391

Unbeschichtet
Uncoated
X

TiN
✓

6H
✓

P	•	N	•
M	•	S	•
K	•	H	•

HSS-E
✓

AGT72737-ISO-...

Schaft / Shank	G Gewinde Thread	P Steigung Pitch	l	l ₁	d _A	4-Kant Square	Kernloch ø / Tap drill size
AGT72737-ISO-M4X0.5 N	M4	0,5	63	10	2,8	2,10	3,50
AGT72737-ISO-M5X0.5 N	M5	0,5	70	11	3,5	2,70	4,50
AGT72737-ISO-M6X0.5 N	M6	0,5	80	13	4,5	3,40	5,50
AGT72737-ISO-M6X0.75 N	M6	0,75	80	13	4,5	3,40	5,20
AGT72737-ISO-M7X0.75 N	M7	0,75	80	14	5,5	4,30	6,20
AGT72737-ISO-M8X0.75 N	M8	0,75	80	14	6	4,90	7,20
AGT72737-ISO-M8X1.0 N	M8	1,00	90	17	6	4,90	7,00
AGT72737-ISO-M10X0.75 N	M10	0,75	90	18	7	5,50	9,20
AGT72737-ISO-M10X1.0 N	M10	1,00	90	18	7	5,50	9,00
AGT72737-ISO-M10X1.25 N	M10	1,25	100	22	7	5,50	8,80
AGT72737-ISO-M12X1.0 N	M12	1,00	100	18	9	7,00	11,00
AGT72737-ISO-M12X1.25 N	M12	1,25	100	22	9	7,00	10,80
AGT72737-ISO-M12X1.5 N	M12	1,5	100	22	9	7,00	10,50
AGT72737-ISO-M14X1.0 N	M14	1,00	100	18	11	9,00	13,00
AGT72737-ISO-M14X1.25 N	M14	1,25	100	22	11	9,00	12,80
AGT72737-ISO-M14X1.5 N	M14	1,5	100	22	11	9,00	12,50
AGT72737-ISO-M16X1.0 N	M16	1,00	100	18	12	9,00	15,00
AGT72737-ISO-M16X1.5 N	M16	1,5	100	22	12	9,00	14,50
AGT72737-ISO-M18X1.0 N	M18	1,00	110	20	14	11,00	17,00
AGT72737-ISO-M18X1.5 N	M18	1,5	110	25	14	11,00	16,50
AGT72737-ISO-M20X1.0 N	M20	1,00	125	20	16	12,00	19,00
AGT72737-ISO-M20X1.5 N	M20	1,5	125	25	16	12,00	18,50

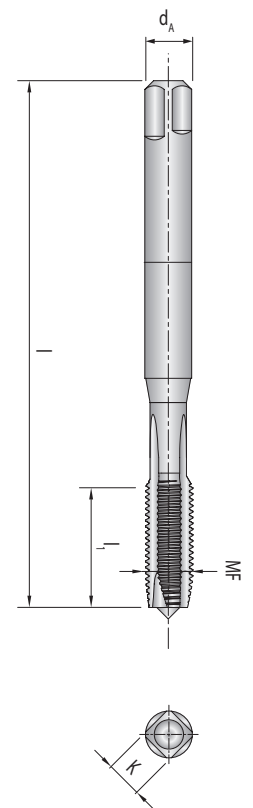

Maschinengewindebohrer

Metrisch ISO Fein - Spiralgenutet



Machine tabs

ISO metric fine threads - Spiral flute

MF

Form C

DIN 374

Unbeschichtet
Uncoated
X

TiN
✓

6H
✓

HSS-E
✓

AGT72637-ISO-...

Schaft / Shank	G Gewinde Thread	P Steigung Pitch	l	l ₁	d _A	4-Kant Square	Kernloch ø / Tap drill size
AGT72637-ISO-M4X0.5 N	M4	0,5	63	5	2,8	2,10	3,50
AGT72637-ISO-M5X0.5 N	M5	0,5	70	5	3,5	2,70	4,50
AGT72637-ISO-M6X0.5 N	M6	0,5	80	5	4,5	3,40	5,50
AGT72637-ISO-M6X0.75 N	M6	0,75	80	8	4,5	3,40	5,20
AGT72637-ISO-M7X0.75 N	M7	0,75	80	10	5,5	4,30	6,20
AGT72637-ISO-M8X0.75 N	M8	0,75	80	8	6	4,90	7,20
AGT72637-ISO-M8X1.0 N	M8	1,0	90	10	6	4,90	7,00
AGT72637-ISO-M10X0.75 N	M10	0,75	90	10	7	5,50	9,20
AGT72637-ISO-M10X1.0 N	M10	1,0	90	10	7	5,50	9,00
AGT72637-ISO-M10X1.25 N	M10	1,25	100	16	7	5,50	8,80
AGT72637-ISO-M12X1.0 N	M12	1,0	100	11	9	7,00	11,00
AGT72637-ISO-M12X1.25 N	M12	1,25	100	15	9	7,00	10,80
AGT72637-ISO-M12X1.5 N	M12	1,5	100	15	9	7,00	10,50
AGT72637-ISO-M14X1.0 N	M14	1,0	100	11	11	9,00	13,00
AGT72637-ISO-M14X1.25 N	M14	1,25	100	15	11	9,00	12,80
AGT72637-ISO-M14X1.5 N	M14	1,5	100	15	11	9,00	12,50
AGT72637-ISO-M16X1.0 N	M16	1,0	100	12	12	9,00	15,00
AGT72637-ISO-M16X1.5 N	M16	1,5	100	12	12	9,00	14,50
AGT72637-ISO-M18X1.0 N	M18	1,0	110	13	14	11,00	17,00
AGT72637-ISO-M18X1.5 N	M18	1,5	110	17	14	11,00	16,50
AGT72637-ISO-M20X1.0 N	M20	1,0	125	14	16	12,00	19,00
AGT72637-ISO-M20X1.5 N	M20	1,5	125	17	16	12,00	18,50

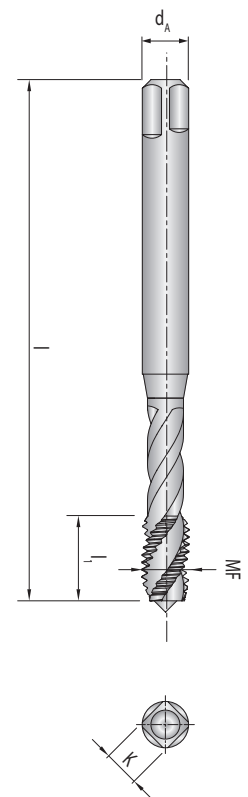

● = Hauptanwendung / Main application
○ = Nebenanwendung / Suitable

Alle Angaben in mm / Dimensions in mm

Maschinengewindebohrer

Metrisch ISO Fein - Gerade Genutet - Für rostfreie Stähle



Machine tabs

ISO metric fine threads - Straight flute - For stainless steels

MF

Form B

DIN 374

TiCN

6H

PM-HSS

P	N
M	S
K	H

VA

AGT72737-ISO-...-VA...

Schaft / Shank	G Gewinde Thread	P Steigung Pitch	l	l ₁	d _A	4-Kant Square	Kernloch ø / Tap drill size
AGT72737-ISO-M4X0.5-VA	M4	0,5	63	10	2,8	2,10	3,50
AGT72737-ISO-M5X0.5-VA	M5	0,5	70	11	3,5	2,70	4,50
AGT72737-ISO-M6X0.5-VA	M6	0,5	80	13	4,5	3,40	5,50
AGT72737-ISO-M6X0.75-VA	M6	0,75	80	13	4,5	3,40	5,20
AGT72737-ISO-M7X0.75-VA	M7	0,75	80	14	5,5	4,30	6,20
AGT72737-ISO-M8X0.75-VA	M8	0,75	80	14	6	4,90	7,20
AGT72737-ISO-M8X1.0-VA	M8	1,00	90	17	6	4,90	7,00
AGT72737-ISO-M10X0.75-VA	M10	0,75	90	18	7	5,50	9,20
AGT72737-ISO-M10X1.0-VA	M10	1,00	90	18	7	5,50	9,00
AGT72737-ISO-M10X1.25-VA	M10	1,25	100	22	7	5,50	8,80
AGT72737-ISO-M12X1.0-VA	M12	1,00	100	18	9	7,00	11,00
AGT72737-ISO-M12X1.25-VA	M12	1,25	100	22	9	7,00	10,80
AGT72737-ISO-M12X1.5-VA	M12	1,5	100	22	9	7,00	10,50

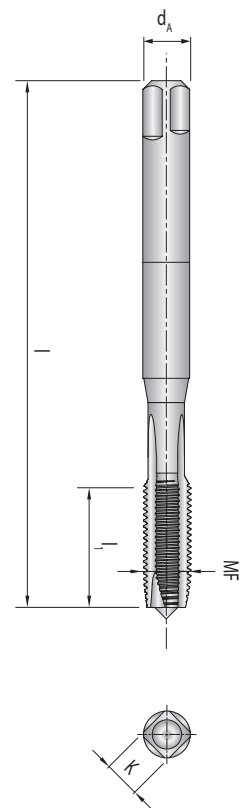

AGT

● = Hauptanwendung / Main application
 ○ = Nebenanwendung / Suitable

Alle Angaben in mm / Dimensions in mm

Maschinengewindebohrer

Metrisch ISO Fein - Spiralgenutet - Für rostfreie Stähle



Machine tabs

ISO metric fine threads - Spiral flute - For stainless steels

MF

Form C

DIN 374

i Seite Page 382-391

60°
P

TiCN

✓

6H

✓

PM-HSS

✓

P	N
M	S
K	H

45°

VA

✓

AGT72637-ISO-...-VA...

Schaft / Shank	G Gewinde Thread	P Steigung Pitch	l	l ₁	d _A	4-Kant Square	Kernloch ø / Tap drill size
AGT72637-ISO-M4X0.5-VA	M4	0,5	63	5	2,8	2,10	3,50
AGT72637-ISO-M5X0.5-VA	M5	0,5	70	5	3,5	2,70	4,50
AGT72637-ISO-M6X0.5-VA	M6	0,5	80	5	4,5	3,40	5,50
AGT72637-ISO-M6X0.75-VA	M6	0,75	80	8	4,5	3,40	5,20
AGT72637-ISO-M7X0.75-VA	M7	0,75	80	10	5,5	4,30	6,20
AGT72637-ISO-M8X0.75-VA	M8	0,75	80	8	6	4,90	7,20
AGT72637-ISO-M8X1.0-VA	M8	1,00	90	10	6	4,90	7,00
AGT72637-ISO-M10X0.75-VA	M10	0,75	90	10	7	5,50	9,20
AGT72637-ISO-M10X1.0-VA	M10	1,00	90	10	7	5,50	9,00
AGT72637-ISO-M10X1.25-VA	M10	1,25	100	16	7	5,50	8,80
AGT72637-ISO-M12X1.0-VA	M12	1,00	100	11	9	7,00	11,00
AGT72637-ISO-M12X1.25-VA	M12	1,25	100	15	9	7,00	10,80
AGT72637-ISO-M12X1.5-VA	M12	1,5	100	15	9	7,00	10,50

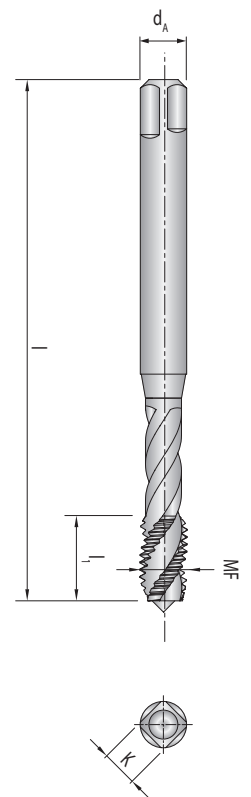

● = Hauptanwendung / Main application
○ = Nebenanwendung / Suitable

Alle Angaben in mm / Dimensions in mm

Maschinengewindebohrer

Amerikanisches Zollgewinde - Gerade Genutet

Machine tabs

Unified coarse threads - Straight flute



UNC

Form B

DIN
371/376

i
Seite
Page
382-391

Unbeschichtet
Uncoated
X

TiN
✓

2B
✓

P	•	N	•
M	•	S	•
K	•	H	•

HSS-E
✓

AGT72739-UNC-...

Schaft / Shank	G Gewinde Thread	P Steigung Pitch	l	l ₁	d _A	4-Kant Square	Kernloch ø / Tap drill size
AGT72739-UNC-#4X40	#4	40,00	56	11	3,5	2,70	2,30
AGT72739-UNC-#5X40	#5	40,00	56	11	3,5	2,70	2,60
AGT72739-UNC-#6X32	#6	32,00	56	12	4	3,00	2,85
AGT72739-UNC-#8X32	#8	32,00	63	13	4,5	3,40	3,50
AGT72739-UNC-#10X24	#10	24,00	70	15	6	4,90	3,90
AGT72739-UNC-#12X24	#12	24,00	80	16	6	4,90	4,50
AGT72739-UNC-1/4X20	1/4"	20,00	80	17	7	5,50	5,20
AGT72739-UNC-5/16X18	5/16"	18,00	90	20	8	6,20	6,60
AGT72739-UNC-3/8X16	3/8"	16,00	100	22	9	7,00	8,00
AGT72739-UNC-7/16X14	7/16"	14,00	100	22	8	6,20	9,40
AGT72739-UNC-1/2X13	1/2"	13,00	110	25	9	7,00	10,75
AGT72739-UNC-9/16X12	9/16"	12,00	110	26	11	9,00	12,25
AGT72739-UNC-5/8X11	5/8"	11,00	110	27	12	9,00	13,50
AGT72739-UNC-3/4X10	3/4"	10,00	125	30	14	11,00	16,50

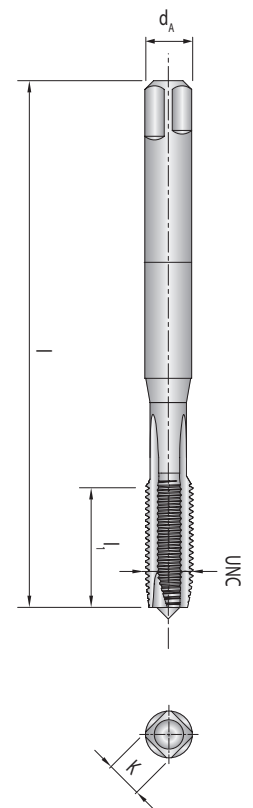

Maschinengewindebohrer

Amerikanisches Zollgewinde - Spiralgenutet



N NEU/NEW

Machine tabs

Unified coarse threads - Spiral flute

UNC		Form C	DIN 371/376	
	Unbeschichtet Uncoated X	TiN ✓	2B ✓	
HSS-E ✓				

AGT72639-UNC-...

Schaft / Shank	G Gewinde Thread	P Steigung Pitch	l	l ₁	d _A	4-Kant Square	Kernloch ø / Tap drill size
AGT72639-UNC-#4X40 N	#4	40,00	56	6	3,5	2,70	2,30
AGT72639-UNC-#5X40 N	#5	40,00	56	7	3,5	2,70	2,60
AGT72639-UNC-#6X32 N	#6	32,00	56	7	4	3,00	2,85
AGT72639-UNC-#8X32 N	#8	32,00	63	8	4,5	3,40	3,50
AGT72639-UNC-#10X24 N	#10	24,00	70	10	6	4,90	3,90
AGT72639-UNC-#12X24 N	#12	24,00	80	10	6	4,90	4,50
AGT72639-UNC-1/4X20 N	1/4"	20,00	80	13	7	5,50	5,20
AGT72639-UNC-5/16X18 N	5/16"	18,00	90	14	8	6,20	6,60
AGT72639-UNC-3/8X16 N	3/8"	16,00	100	16	9	7,00	8,00
AGT72639-UNC-7/16X14 N	7/16"	14,00	100	17	8	6,20	9,40
AGT72639-UNC-1/2X13 N	1/2"	13,00	110	20	9	7,00	10,75
AGT72639-UNC-9/16X12 N	9/16"	12,00	110	20	11	9,00	12,25
AGT72639-UNC-5/8X11 N	5/8"	11,00	110	22	12	9,00	13,50
AGT72639-UNC-3/4X10 N	3/4"	10,00	125	25	14	11,00	16,50

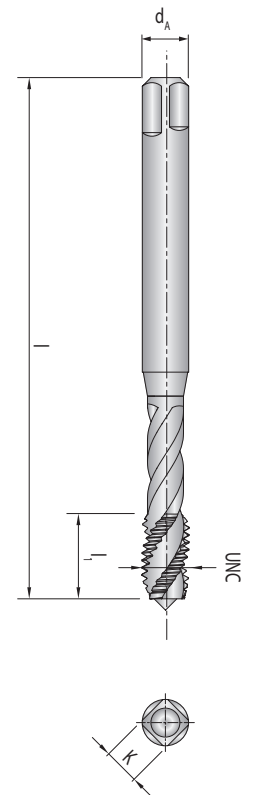

● = Hauptanwendung / Main application
○ = Nebenanwendung / Suitable

Alle Angaben in mm / Dimensions in mm

Maschinengewindebohrer

Amerikanisches Zollgewinde Fein - Gerade Genutet

Machine tabs

Unified fine threads - Straight flute



UNF

Form B

DIN 371/376

Unbeschichtet
Uncoated

TiN

2B

P	N
M	S
K	H

HSS-E

AGT72738-UNF-...

Schaft / Shank	G Gewinde Thread	P Steigung Pitch	l	l ₁	d _A	4-Kant Square	Kernloch ø / Tap drill size
AGT72738-UNF-#4X48	#4	48,00	56	11	3,5	2,70	2,40
AGT72738-UNF-#5X44	#5	44,00	56	11	3,5	2,70	2,70
AGT72738-UNF-#6X40	#6	40,00	56	12	4	3,00	3,00
AGT72738-UNF-#8X36	#8	36,00	63	13	4,5	3,40	3,50
AGT72738-UNF-#10X32	#10	32,00	70	15	6	4,90	4,10
AGT72738-UNF-#12X28	#12	28,00	80	16	6	4,90	4,70
AGT72738-UNF-1/4X28	1/4"	28,00	80	17	7	5,50	5,50
AGT72738-UNF-5/16X24	5/16"	24,00	90	17	8	6,20	6,90
AGT72738-UNF-3/8X24	3/8"	24,00	100	18	9	7,00	8,50
AGT72738-UNF-7/16X20	7/16"	20,00	100	22	8	6,20	9,90
AGT72738-UNF-1/2X20	1/2"	20,00	100	22	9	7,00	11,50
AGT72738-UNF-9/16X18	9/16"	18,00	100	22	11	9,00	12,90
AGT72738-UNF-5/8X18	5/8"	18,00	100	22	12	9,00	14,50
AGT72738-UNF-3/4X16	3/4"	16,00	110	25	14	11,00	17,50

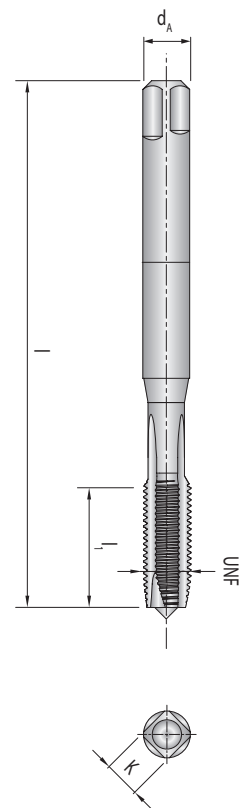

Maschinengewindebohrer

Amerikanisches Zollgewinde Fein - Spiralgenutet



Machine tabs

Unified fine threads - Spiral flute

UNF		Form C	DIN 371/376	
	Unbeschichtet Uncoated 	TiN 	2B 	
HSS-E 				

AGT72638-UNF-...

Schaft / Shank	G Gewinde Thread	P Steigung Pitch	l	l ₁	d _A	4-Kant Square	Kernloch ø / Tap drill size
AGT72638-UNF-#4X48	#4	48,00	56	6	3,5	2,70	2,40
AGT72638-UNF-#5X44	#5	44,00	56	7	3,5	2,70	2,70
AGT72638-UNF-#6X40	#6	40,00	56	7	4	3,00	3,00
AGT72638-UNF-#8X36	#8	36,00	63	8	4,5	3,40	3,40
AGT72638-UNF-#10X32	#10	32,00	70	10	6	4,90	4,10
AGT72638-UNF-#12X28	#12	28,00	80	10	6	4,90	4,70
AGT72638-UNF-1/4X28	1/4"	28,00	80	10	7	5,50	5,50
AGT72638-UNF-5/16X24	5/16"	24,00	90	10	8	6,20	6,90
AGT72638-UNF-3/8X24	3/8"	24,00	100	10	9	7,00	8,50
AGT72638-UNF-7/16X20	7/16"	20,00	100	13	8	6,20	9,90
AGT72638-UNF-1/2X20	1/2"	20,00	100	13	9	7,00	11,50
AGT72638-UNF-9/16X18	9/16"	18,00	100	15	11	9,00	12,90
AGT72638-UNF-5/8X18	5/8"	18,00	100	15	12	9,00	14,50
AGT72638-UNF-3/4X16	3/4"	16,00	110	17	14	11,00	17,50

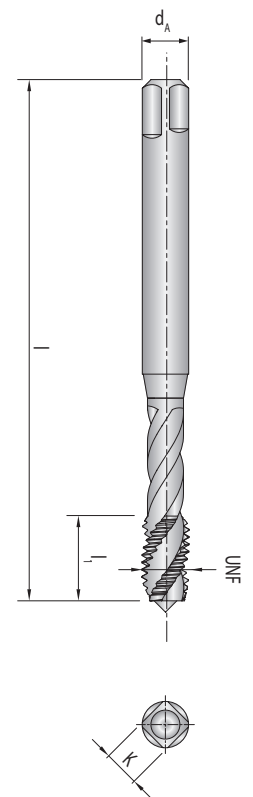

● = Hauptanwendung / Main application
○ = Nebenanwendung / Suitable

Alle Angaben in mm / Dimensions in mm

Definitionen am Gewindebohrer / Taps terminology

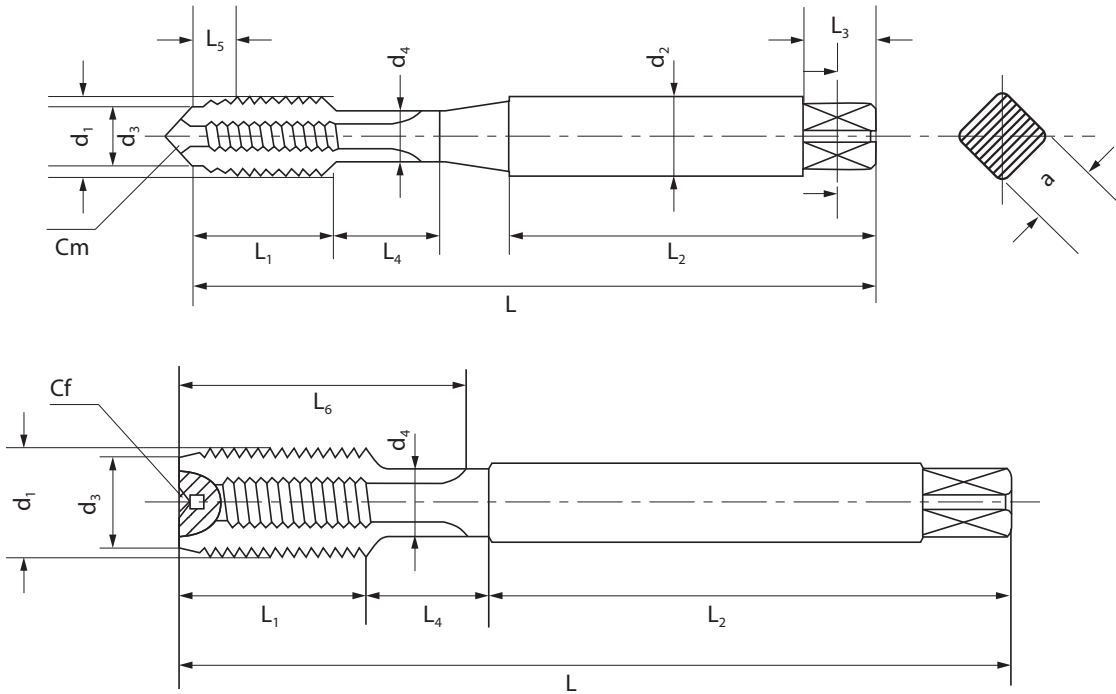

- d_1 Nenn Aussendurchmesser / Major diameter
- d_A Schaftdurchmesser / Shank diameter
- d_3 Anschnittdurchmesser / Chamfer diameter
- d_4 Bunddurchmesser / Neck diameter
- L Gesamtlänge / Total length
- L_1 Gewindelänge / Thread length
- L_2 Schaftlänge / Shank length
- L_3 Vierkantlänge / Square length
- L_4 Bundlänge / Neck length
- L_5 Anschnittlänge / Chamfer length
- L_6 Nutenlänge / Flutes length
- a Vierkantmaß / Square
- C_m Mittelpunkt des Außengewindes / Center male
- C_f Mittelpunkt des Innengewindes / Center female

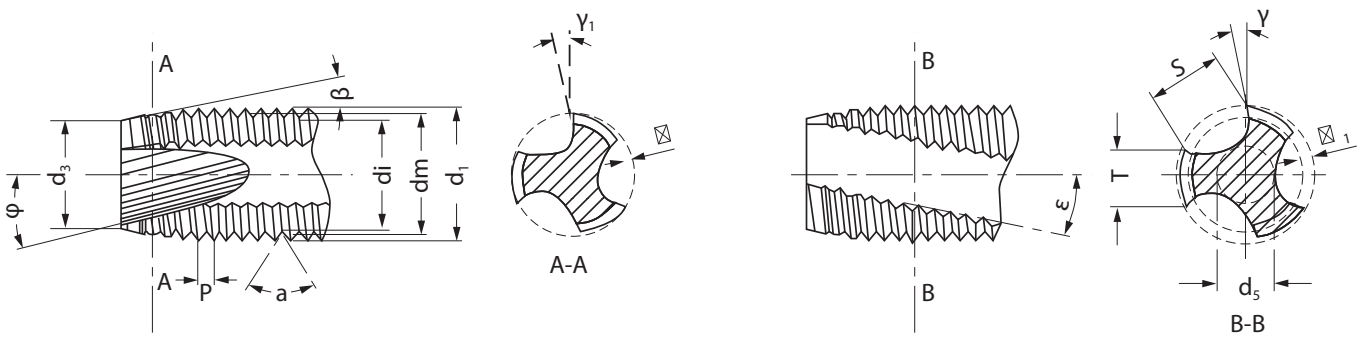

- d_1 Nenn Aussendurchmesser / Major diameter
- d_m Flankendurchmesser / Flank diameter
- d_1 Kerndurchmesser / Minor diameter
- d_3 Anschnittdurchmesser / Chamfer diameter
- P Steigung / Pitch
- a Flankenwinkel / Flank angle
- β Anschnittwinkel / Chamfer angle
- φ Schälswinkel / Gun nose angle
- γ Schälswinkel / Gun nose rake angle in front
- Δ Hinterschliff am Anschnitt / Chamfer relief
- Δ_1 Flankenhinterschliff auf Zahnbreite / Pitch diameter relief on the land
- γ Spanwinkel / Rake angle
- T Zahnstollenbreite / Width of land
- S Nutenbreite / Flute width
- d_5 Seelendicke / Web thickness
- ϵ Spiralwinkel / Angle of spiral flute

Empfohlene Kernlochmaße / Recommended tap drill size

Metrisches ISO Gewinde Metric-ISO threads coarse pitch			
M	Steigung Pitch	Bohrdurchmesser Drill diameter	
		Max	Min
1	0,25	0,785	0,75
1,1	0,25	0,885	0,85
1,2	0,25	0,985	0,95
1,4	0,30	1,160	1,10
1,6	0,35	1,321	1,25
1,7	0,35	1,346	1,30
1,8	0,35	1,521	1,45
2	0,40	1,679	1,60
2,2	0,45	1,838	1,75
2,3	0,40	1,920	1,90
2,5	0,45	2,138	2,05
2,6	0,45	2,176	2,10
3	0,50	2,599	2,50
3,5	0,60	3,010	2,90
4	0,70	3,422	3,30
4,5	0,75	3,878	3,70
5	0,80	4,334	4,20
6	1,00	5,153	5,00
7	1,00	6,153	6,00
8	1,25	6,912	6,80
9	1,25	7,912	7,80
10	1,50	8,676	8,50
11	1,50	9,676	9,50
12	1,75	10,441	10,20
14	2,00	12,210	12,00
16	2,00	14,210	14,00
18	2,50	15,744	15,50
20	2,50	17,744	17,50
22	2,50	19,744	19,50
24	3,00	21,252	21,00
27	3,00	24,252	24,00
30	3,50	26,771	26,50
33	3,50	29,771	29,50
36	4,00	32,270	32,00
39	4,00	35,270	35,00
42	4,50	37,799	37,50
45	4,50	40,799	40,50
48	5,00	43,297	43,00
52	5,00	47,297	47,00
56	5,50	50,796	50,50
60	5,50	54,796	54,50
64	6,00	58,305	58,00
68	6,00	62,305	62,00

Metrisches ISO Fein-Gewinde Metric-ISO threads fine pitch			
MF	Steigung Pitch	Bohrdurchmesser Drill diameter	
		Max	Min
2,5	0,35	2,221	2,15
3	0,35	2,271	2,65
3,5	0,35	3,221	3,15
4	0,50	3,599	3,50
4,5	0,50	4,099	4,00
5	0,50	4,599	4,50
5,5	0,50	5,099	5,00
6	0,75	5,378	5,20
7	0,75	6,378	6,20
8	0,75	7,378	7,20
8	1,00	7,153	7,00
9	0,75	8,378	8,20
9	1,00	8,153	8,00
10	0,75	9,378	9,20
10	1,00	9,153	9,00
10	1,25	8,912	8,80
11	0,75	10,378	10,20
11	1,00	10,153	10,00
12	1,00	11,153	11,00
12	1,25	10,912	10,80
12	1,50	10,676	10,50
14	1,00	13,153	13,00
14	1,25	12,912	12,80
14	1,50	12,676	12,50
15	1,00	14,153	14,00
15	1,50	13,676	13,50
16	1,00	15,153	15,00
16	1,50	14,676	14,50
17	1,00	16,153	16,00
17	1,50	15,676	15,50
18	1,00	17,153	17,00
18	1,50	16,676	16,50
18	2,00	16,210	16,00
20	1,00	19,153	19,00
20	1,50	18,676	18,50
20	2,00	18,210	18,00
22	1,00	21,153	21,00
22	1,50	20,676	20,50
22	2,00	20,210	20,00
24	1,00	23,153	23,00
24	1,50	22,676	22,50
24	2,00	22,210	22,00
25	1,00	24,153	24,00
25	1,50	23,676	23,50

Metrisches ISO Fein-Gewinde Metric-ISO threads fine pitch			
MF	Steigung Pitch	Bohrdurchmesser Drill diameter	
		Max	Min
25	2,00	23,210	23,00
26	1,50	24,676	24,50
27	1,00	26,153	26,00
27	1,50	25,676	25,50
27	2,00	25,210	25,00
28	1,00	27,153	27,00
28	1,50	26,676	26,50
28	2,00	26,210	26,00
30	1,00	29,153	29,00
30	1,50	28,676	28,50
30	2,00	28,210	28,00
30	3,00	27,252	27,00
32	1,50	30,675	30,50
32	2,00	30,210	30,00
33	1,50	31,676	31,50
33	2,00	31,210	31,00
33	3,00	30,252	30,00
35	1,50	33,676	33,50
36	1,50	34,676	34,50
36	2,00	34,210	34,00
36	3,00	33,252	33,00
38	1,50	36,676	36,50
39	1,50	37,676	37,50
39	2,00	37,210	37,00
39	3,00	36,252	36,00
40	1,50	38,676	38,50
40	2,00	38,210	38,00
40	3,00	37,252	37,00
42	1,50	40,676	40,50
42	2,00	40,210	40,00
42	3,00	39,252	39,00
45	1,50	43,676	43,50
45	2,00	43,210	43,00
45	3,00	42,252	42,00
48	1,50	46,676	46,50
48	2,00	46,210	46,00
48	3,00	45,252	45,00
50	1,50	48,676	48,50
50	2,00	48,210	48,00
50	3,00	47,252	47,00
52	1,50	50,676	50,50
52	2,00	50,210	50,00
52	3,00	49,252	49,00

Allgemeine Anwendungshinweise

Gewindebohrer

General recommendation

Taps

Empfohlene Kernlochmaße / Recommended tap drill size

Amerikanisches Zollgewinde American Unified coarse threads			
UNC	T.P.I	Bohrdurchmesser Drill diameter	
		Max	Min
#1	64	1,585	1,50
#2	56	1,872	1,80
#3	48	2,146	2,10
#4	40	2,385	2,30
#5	40	2,697	2,60
#6	32	2,896	2,85
#8	32	3,528	3,50
#10	24	3,950	3,90
#12	24	4,590	4,50
1/4"	20	5,250	5,20
5/16"	18	6,680	6,60
3/8"	16	8,082	8,00
7/16"	14	9,441	9,40
1/2"	13	10,881	10,75
9/16"	12	12,301	12,25
5/8"	11	13,693	13,50
3/4"	10	16,624	16,50
7/8"	9	19,520	19,50
1"	8	22,344	22,25
1*1/8"	7	25,082	25,00
1*1/4"	7	28,258	28,25
1*3/8"	6	30,851	30,75
1*1/2"	6	34,026	34,00
1*3/4"	5	39,560	39,50
2"	4,5	45,367	45,25

Amerikanisches Zoll-Fein-Gewinde American Unified fine threads			
UNF	T.P.I	Bohrdurchmesser Drill diameter	
		Max	Min
#0	80	1,306	1,30
#1	72	1,613	1,60
#2	64	1,913	1,90
#3	56	2,197	2,10
#4	48	2,459	2,40
#5	44	2,741	2,70
#6	40	3,012	3,00
#8	36	3,597	3,50
#10	32	4,168	4,10
#12	28	4,717	4,70
1/4"	28	5,563	5,50
5/16"	24	6,995	6,90
3/8"	24	8,565	8,50
7/16"	20	9,947	9,90
1/2"	20	11,524	11,50
9/16"	18	12,969	12,90
5/8"	18	14,554	14,50
3/4"	16	17,546	17,50
7/8"	14	20,493	20,50
1"	12	23,363	23,25
1*1/8"	12	26,538	26,50
1*1/4"	12	29,713	29,50
1*3/8"	12	32,888	32,70
1*1/2"	12	36,063	36,00

Empfohlene Schnittwerte

Ausführung AGT

Recommended cutting data

Design AGT

Durchmesser / Diameter [mm]	Korrekturfaktor / Correction factor Kf [f _z]															
	1	2	3	4	5	6	8	10	12	15	20	25	30	40	50	60
	m/min	m/min	m/min	m/min	m/min	m/min	m/min	m/min	m/min	m/min	m/min	m/min	m/min	m/min	m/min	m/min
	[U/min] / [rev/min]															
2	159	318	478	637	796	955	1274	1592	1911	2388	3185	3981	4777	6369	7962	9554
3	106	212	318	425	531	637	849	1062	1274	1592	2133	2654	3185	4246	5308	6369
4	80	159	239	318	398	478	637	796	955	1194	1592	1990	2389	3185	3961	4777
5	64	127	191	255	318	382	510	637	764	955	1274	1592	1911	2548	3185	3822
6	53	106	159	212	265	318	425	531	637	796	1062	1327	1592	2123	2653	3185
8	40	80	119	159	199	239	318	398	478	597	796	955	1194	1592	1990	2388
10	31	64	96	127	159	191	255	318	382	478	637	796	955	1274	1592	1911
12	26	53	80	106	133	159	212	265	318	398	531	863	796	1062	1327	1592
14	23	45	68	91	114	136	182	227	273	341	455	569	682	910	1137	1365
16	20	40	60	80	100	119	159	199	239	299	398	498	597	796	995	1194
18	18	35	53	71	88	106	142	177	212	265	354	442	531	708	885	1062
20	16	32	48	64	80	96	127	159	191	239	318	398	476	637	796	955

AGT

Toleranzklassen und Toleranzfelder für Schraubengewinde entsprechen dem metrischen ISO-Standard
 Tolerance classes of taps and tolerance positions for screw threads as per Metric ISO Standard

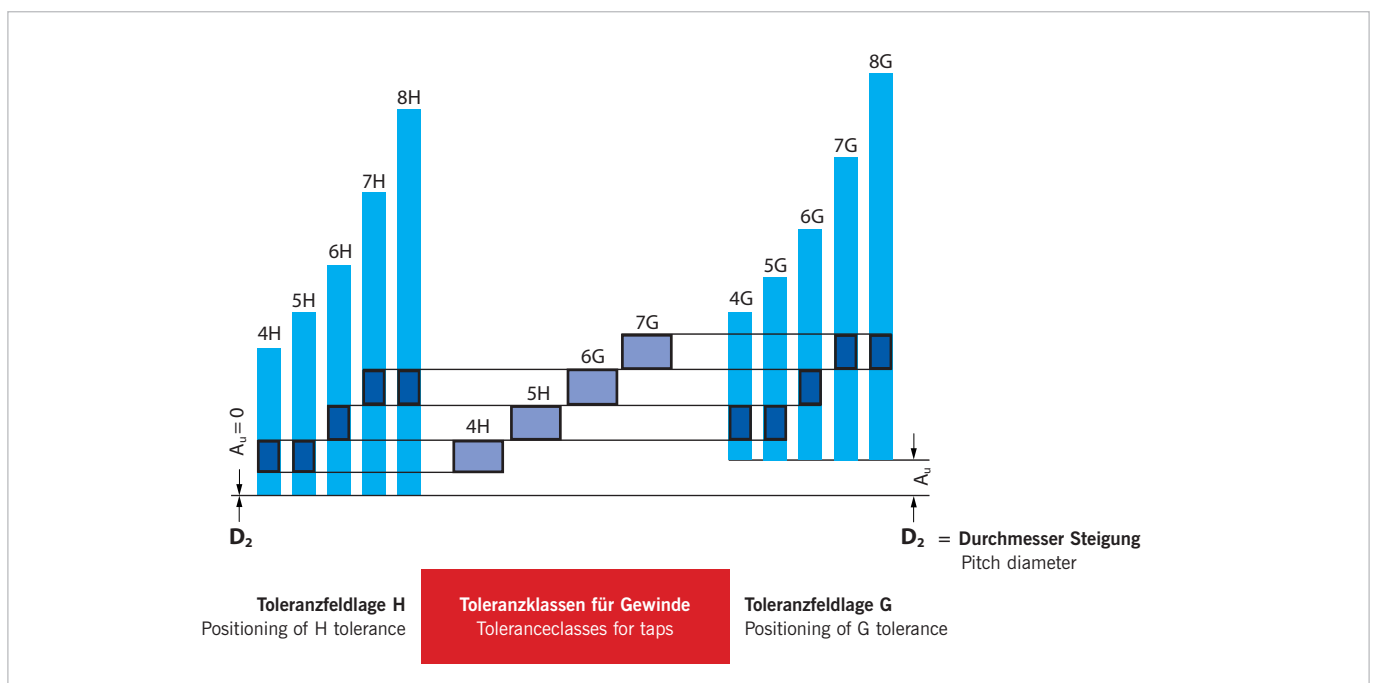
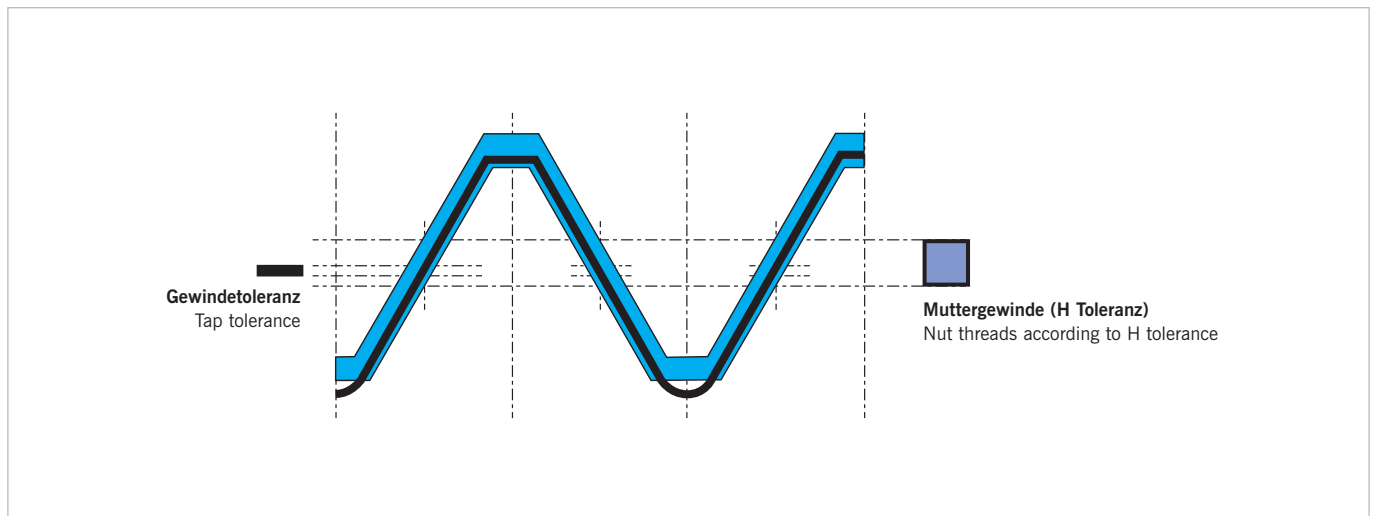

Gewindetoleranz Tap tolerance ISO	Gewindetoleranz Tap tolerance DIN	Toleranzklassen Innengewinde Correct class to obtain nut thread with tolerance				
ISO 1	4H	4H	5H	–	–	–
ISO 2	6H	4G	5G	6H	–	–
ISO 3	6G	–	–	6G	7H	8H
–	7G	–	–	–	7G	8G

M Metrisches ISO Gewinde / Metric ISO coarse thread

H = 0.86603P		
H ₁ =	5 8	H = 0,54127P
h ₃ =	17 24	H = 0,61343P
d ₂ = D ₂ = d - H =	3 4	d - 0,64952P
d ₃ = d - 2h ₃ = d - 1,22687P		
r =	H 6	= 0,14434P

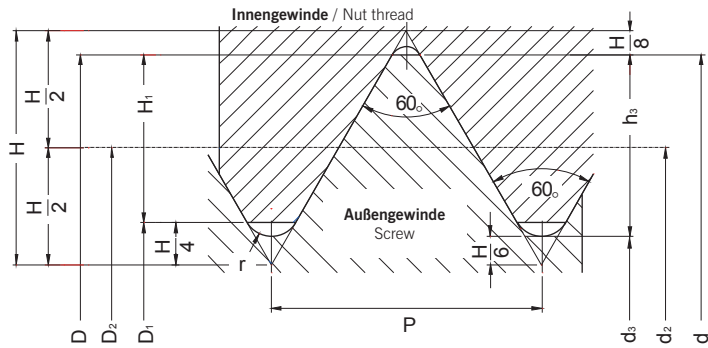

Gewinde Nominal diameter	Steigung Pitch	Flanken ø Pitch ø	Kern ø Minor ø		Gewindetiefe Thread depth		Radius	Toleranz Gewindebohrer Tap tolerance 6H		Toleranz Innengewinde Nut tolerance 6H	
			Außengewinde Screw	Innengewinde Nut	Außengewinde Screw	Innengewinde Nut		Min	Max	Min	Max
d = D	P	d ₂ = D ₂	d ₃	D ₁	h ₃	H ₁	r	d ₂			
M 1.6	0,35	1,373	1,171	1,221	0,215	0,189	0,051	1,393	1,407	1,373	1,458
M 1.8	0,35	1,573	1,371	1,421	0,215	0,189	0,051	1,593	1,607	1,573	1,658
M 2	0,40	1,740	1,509	1,567	0,245	0,217	0,058	1,761	1,776	1,740	1,830
M 2.2	0,45	1,908	1,648	1,713	0,276	0,244	0,065	1,931	1,946	1,908	2,003
M 2.5	0,45	2,208	1,948	2,013	0,276	0,244	0,065	2,231	2,246	2,208	2,303
M 3	0,50	2,675	2,387	2,459	0,307	0,271	0,072	2,699	2,715	2,675	2,775
M 3.5	0,60	3,110	2,764	2,850	0,368	0,325	0,087	3,137	3,155	3,110	3,222
M 4	0,70	3,545	3,141	3,242	0,429	0,379	0,101	3,574	3,593	3,545	3,663
M 4.5	0,75	4,013	3,580	3,688	0,460	0,406	0,108	4,042	4,061	4,013	4,131
M 5	0,80	4,480	4,019	4,134	0,491	0,433	0,115	4,510	4,530	4,480	4,605
M 6	1,00	5,350	4,773	4,917	0,613	0,541	0,144	5,385	5,409	5,350	5,500
M 7	1,00	6,350	5,773	5,917	0,613	0,541	0,144	6,385	6,409	6,350	6,500
M 8	1,25	7,188	6,466	6,647	0,767	0,677	0,180	7,226	7,251	7,188	7,348
M 9	1,25	8,188	7,466	7,647	0,767	0,677	0,180	8,226	8,251	8,188	8,348
M 10	1,50	9,026	8,160	8,376	0,920	0,812	0,217	9,068	9,096	9,026	9,206
M 11	1,50	10,026	9,160	9,376	0,920	0,812	0,217	10,068	10,096	10,026	10,206
M 12	1,75	10,863	9,853	10,106	1,074	0,947	0,253	10,911	10,943	10,863	11,063
M 14	2,00	12,701	11,546	11,835	1,227	1,083	0,289	12,752	12,786	12,701	12,913
M 16	2,00	14,701	13,546	13,835	1,227	1,083	0,289	14,752	14,786	14,701	14,913
M 18	2,50	16,376	14,933	15,294	1,534	1,353	0,361	16,430	16,466	16,376	16,600
M 20	2,50	18,376	16,933	17,294	1,534	1,353	0,361	18,430	18,466	18,376	18,600
M 22	2,50	20,376	18,933	19,294	1,534	1,353	0,361	20,430	20,466	20,376	20,600
M 24	3,00	22,051	20,319	20,752	1,840	1,624	0,433	22,115	22,157	22,051	22,316
M 27	3,00	25,051	23,319	23,752	1,840	1,624	0,433	25,115	25,157	25,051	25,316
M 30	3,50	27,727	25,706	26,211	2,147	1,894	0,505	27,794	27,839	27,727	28,007
M 33	3,50	30,727	28,706	29,211	2,147	1,894	0,505	30,794	30,839	30,727	31,007
M 36	4,00	33,402	31,093	31,670	2,454	2,165	0,577	33,473	33,520	33,402	33,702
M 39	4,00	36,402	34,093	34,670	2,454	2,165	0,577	36,473	36,520	36,402	36,702
M 42	4,50	39,077	36,479	37,129	2,760	2,436	0,650	39,152	39,202	39,077	39,392
M 45	4,50	42,077	39,479	40,129	2,760	2,436	0,650	42,152	42,202	42,077	42,392
M 48	5,00	44,752	41,866	42,587	3,067	2,706	0,722	44,832	44,885	44,752	45,087
M 52	5,00	48,752	45,866	46,587	3,067	2,706	0,722	48,832	48,885	48,752	49,087
M 56	5,50	52,428	49,252	50,046	3,374	2,977	0,794	52,512	52,568	52,428	52,783
M 60	5,50	56,428	53,252	54,046	3,374	2,977	0,794	56,512	56,568	56,428	56,783
M 64	6,00	60,103	56,639	57,505	3,681	3,248	0,866	60,193	60,253	60,103	60,478
M 68	6,00	64,103	60,639	61,505	3,681	3,248	0,866	64,193	64,253	64,103	64,478

Nennmaße gemäß UNI 4535-64 / Nominal dimensions UNI 4535-64
 Fertigungstoleranzen Flankendurchmesser ISO 6H / Production tolerances on tap flank diameter for ISO 6H nut threads
 Grenzmaße-Muttergewinde nach ISO 6H / Limit dimensions-Nut threads ISO 6H

AGT

MF Metrisches ISO Feingewinde / Metric ISO fine thread

H = 0,86603P		
H ₁ =	5 8	H = 0,54127P
h ₃ =	17 24	H = 0,61343P
d ₂ = D ₂ = d - H =	3 4	d - 0,64952P
d ₃ = d - 2h ₃ = d - 1,22687P		
r =	H 6	= 0,14434P

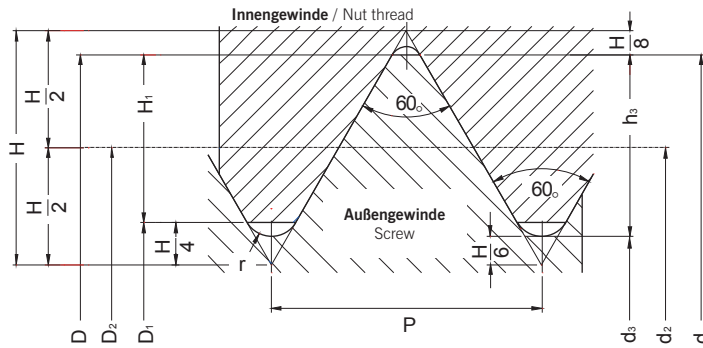

Gewinde Nominal diameter	Steigung Pitch	Flanken ø Pitch ø	Kern ø Minor ø		Gewindetiefe Thread depth		Radius	Toleranz Gewindebohrer Tap tolerance 6H		Toleranz Innengewinde Nut tolerance 6H	
			Außengewinde Screw	Innengewinde Nut	Außengewinde Screw	Innengewinde Nut		Min	Max	Min	Max
d = D	P	d ₂ = D ₂	d ₃	D ₁	h ₃	H ₁	r	d ₂			
M 2	0,25	1,84	1,69	1,73	0,15	0,14	0,04	1,844	1,856	1,838	1,886
M 2.5	0,35	2,27	2,70	2,12	0,22	0,19	0,05	2,293	2,307	2,273	2,358
M 3	0,35	2,77	2,57	2,62	0,22	0,19	0,05	2,794	2,809	2,773	2,863
M 3.5	0,35	3,27	3,07	3,12	0,22	0,19	0,05	3,294	3,309	3,273	3,363
M 4	0,50	3,68	3,39	3,46	0,31	0,27	0,07	3,699	3,715	3,675	3,775
M 4.5	0,50	4,18	3,89	3,96	0,31	0,27	0,07	4,199	4,215	4,175	4,275
M 5	0,50	4,68	4,39	4,46	0,31	0,27	0,07	4,699	4,715	4,675	4,775
M 5.5	0,50	5,18	4,89	4,96	0,31	0,27	0,07	5,199	5,215	5,175	5,275
M 6	0,50	5,68	5,39	5,46	0,31	0,27	0,07	5,702	5,720	5,675	5,787
M 6	0,75	5,51	5,08	5,19	0,46	0,41	0,11	5,545	5,566	5,513	5,645
M 7	0,75	6,51	6,08	6,19	0,46	0,41	0,11	6,545	6,566	6,513	6,645
M 8	0,50	7,68	7,39	7,46	0,31	0,27	0,07	7,702	7,720	7,675	7,787
M 8	0,75	7,51	7,08	7,19	0,46	0,41	0,11	7,545	7,566	7,513	7,645
M 8	1,00	7,35	6,77	6,92	0,61	0,54	0,14	7,835	7,409	7,350	7,500
M 9	0,75	8,51	8,08	8,19	0,46	0,41	0,11	8,545	8,566	8,513	8,645
M 9	1,00	8,35	7,77	7,92	0,61	0,54	0,14	8,385	8,409	8,350	8,500
M 10	0,50	9,68	9,39	9,46	0,31	0,27	0,07	9,702	9,720	9,675	9,787
M 10	0,75	9,51	9,08	9,19	0,46	0,41	0,11	9,545	9,566	9,513	9,645
M 10	1,00	9,35	8,77	8,92	0,61	0,54	0,14	9,385	9,409	9,350	9,500
M 10	1,25	9,19	8,47	8,65	0,77	0,68	0,18	9,226	9,251	9,188	9,348
M 11	0,75	10,51	10,08	10,19	0,46	0,41	0,11	10,545	10,566	10,513	10,645
M 11	1,00	10,35	9,77	9,92	0,61	0,54	0,14	10,385	10,409	10,350	10,500
M 12	0,75	11,51	11,08	11,19	0,46	0,41	0,11	11,547	11,569	11,513	11,653
M 12	1,00	11,35	10,77	10,92	0,61	0,54	0,14	11,388	11,413	11,350	11,510
M 12	1,25	11,19	10,47	10,65	0,77	0,68	0,18	11,230	11,258	11,188	11,368
M 12	1,50	11,03	10,16	10,38	0,92	0,81	0,22	11,071	11,101	11,026	11,216
M 13	1,00	12,35	11,77	11,92	0,61	0,54	0,14	12,388	12,413	12,350	12,510
M 14	1,00	13,35	12,77	12,92	0,61	0,54	0,14	13,388	13,413	13,350	13,510
M 14	1,25	13,19	12,47	12,65	0,77	0,68	0,18	13,230	13,258	13,188	13,368
M 14	1,50	13,03	12,16	12,38	0,92	0,81	0,22	13,071	13,101	13,026	13,216
M 15	1,00	14,35	13,77	13,92	0,61	0,54	0,14	14,388	14,413	14,350	14,510
M 15	1,50	14,03	13,16	13,38	0,92	0,81	0,22	14,071	14,101	14,026	14,216
M 16	1,00	15,35	14,77	14,92	0,61	0,54	0,14	15,388	15,413	15,350	15,510
M 16	1,25	15,19	14,47	14,65	0,77	0,68	0,18	15,230	15,258	15,188	15,368
M 16	1,50	15,03	14,16	14,38	0,92	0,81	0,22	15,071	15,101	15,026	15,216
M 17	1,00	16,35	15,77	15,92	0,61	0,54	0,14	16,388	16,413	16,350	16,510
M 17	1,50	16,03	15,16	15,38	0,92	0,81	0,22	16,071	16,101	16,026	16,216
M 18	1,00	17,35	16,77	16,92	0,61	0,54	0,14	17,388	17,413	17,350	17,510
M 18	1,50	17,03	16,16	16,38	0,92	0,81	0,22	17,071	17,101	17,026	17,216
M 18	2,00	16,70	15,55	15,84	1,23	1,08	0,29	16,752	16,786	16,701	16,913
M 20	1,00	19,35	18,77	18,92	0,61	0,54	0,14	19,388	19,413	19,350	19,510
M 20	1,50	19,03	18,16	18,38	0,92	0,81	0,22	19,071	19,101	19,026	19,216
M 20	2,00	18,70	17,55	17,84	1,23	1,08	0,29	18,752	18,786	18,701	18,913
M 22	1,00	21,35	20,77	20,92	0,61	0,54	0,14	21,388	21,413	21,350	21,510
M 22	1,50	21,03	20,16	20,38	0,92	0,81	0,22	21,071	21,101	21,026	21,216
M 22	2,00	20,70	19,55	19,84	1,23	1,08	0,29	20,752	20,786	20,701	20,913

MF Metrisches ISO Feingewinde / Metric ISO fine thread

H = 0,86603P		
H ₁ =	5 8	H = 0,54127P
h ₃ =	17 24	H = 0,61343P
d ₂ = D ₂ = d - H =	3 4	d - 0,64952P
d ₃ = d - 2h ₃ = d - 1,22687P		
r =	H 6	= 0,14434P

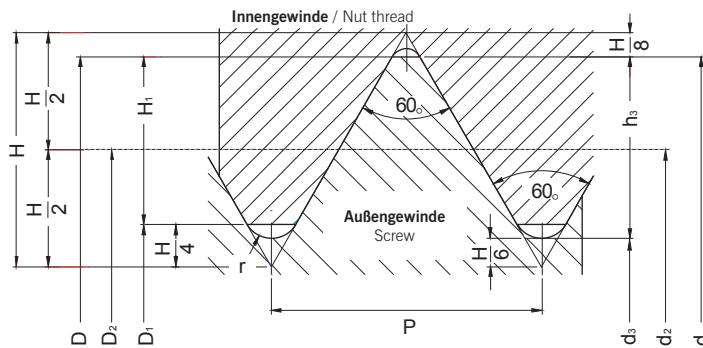

Gewinde Nominal diameter	Steigung Pitch	Flanken ø Pitch ø	Kern ø Minor ø		Gewindetiefe Thread depth		Radius	Toleranz Gewindebohrer Tap tolerance 6H		Toleranz Innengewinde Nut tolerance 6H	
			Außengewinde Screw	Innengewinde Nut	Außengewinde Screw	Innengewinde Nut		Min	Max	Min	Max
d = D	P	d ₂ = D ₂	d ₃	D ₁	h ₃	H ₁	r	d ₂			
M 24	1,00	23,35	22,77	22,92	0,61	0,54	0,14	23,390	23,416	23,350	23,520
M 24	1,50	23,03	22,16	22,38	0,92	0,81	0,22	23,074	23,106	23,026	23,226
M 24	2,00	22,70	21,55	21,84	1,23	1,08	0,29	22,754	22,791	22,701	22,925
M 25	1,00	24,35	23,77	23,92	0,61	0,54	0,14	24,390	24,416	24,350	24,520
M 25	1,50	24,03	23,16	23,38	0,92	0,81	0,22	24,074	24,106	24,026	24,226
M 25	2,00	23,70	22,55	22,84	1,23	1,08	0,29	23,754	23,791	23,701	23,925
M 26	1,00	25,35	24,77	24,92	0,61	0,54	0,14	25,390	25,416	25,350	25,520
M 26	1,50	25,03	24,16	24,38	0,92	0,81	0,22	25,074	25,106	25,026	25,226
M 26	2,00	24,70	23,55	23,84	1,23	1,08	0,29	24,754	24,791	24,701	24,925
M 27	1,00	26,35	25,77	25,92	0,61	0,54	0,14	26,390	26,416	26,350	26,520
M 27	1,50	26,03	25,16	25,38	0,92	0,81	0,22	26,074	26,106	26,026	26,226
M 27	2,00	25,70	24,55	24,84	1,23	1,08	0,29	25,754	25,791	25,701	25,925
M 28	1,00	27,35	26,77	26,92	0,61	0,54	0,14	27,390	27,416	27,350	27,520
M 28	1,50	27,03	26,16	26,38	0,92	0,81	0,22	27,074	27,106	27,026	27,226
M 28	2,00	26,70	25,55	25,84	1,23	1,08	0,29	26,754	26,791	26,701	26,925
M 30	1,00	29,35	28,77	28,92	0,61	0,54	0,14	29,390	29,416	29,350	29,520
M 30	1,50	29,03	28,16	28,38	0,92	0,81	0,22	29,074	29,106	29,026	29,226
M 30	2,00	28,70	27,55	27,84	1,23	1,08	0,29	28,754	28,791	28,701	28,925
M 30	3,00	28,05	26,32	26,75	1,84	1,62	0,43	28,115	28,157	28,051	28,316
M 32	1,50	31,03	30,16	30,38	0,92	0,81	0,22	31,074	31,106	31,026	31,226
M 32	2,00	30,70	29,55	29,84	1,23	1,08	0,29	30,754	30,791	30,701	30,925
M 33	1,50	32,03	31,16	31,38	0,92	0,81	0,22	32,074	32,106	32,026	32,226
M 33	2,00	31,70	30,55	30,84	1,23	1,08	0,29	31,754	31,791	31,701	31,925
M 33	3,00	31,05	29,32	29,75	1,84	1,62	0,43	31,115	31,157	31,051	31,316
M 35	1,50	34,03	33,16	33,38	0,92	0,81	0,22	34,074	34,106	34,026	34,226
M 35	2,00	33,70	32,55	32,84	1,23	1,08	0,29	33,754	33,791	33,701	33,925
M 36	1,50	35,03	34,16	34,38	0,92	0,81	0,22	35,074	35,106	35,026	35,226
M 36	2,00	34,70	33,55	33,84	1,23	1,08	0,29	34,754	34,791	34,701	34,925
M 36	3,00	34,05	32,32	32,75	1,84	1,62	0,43	34,115	34,157	34,051	34,316
M 38	1,50	37,03	36,16	36,38	0,92	0,81	0,22	37,074	37,106	37,026	37,226
M 39	1,50	38,03	37,16	37,38	0,92	0,81	0,22	38,074	38,106	38,026	38,226
M 39	2,00	37,70	36,55	36,84	1,23	1,08	0,29	37,754	37,791	37,701	37,925
M 39	3,00	37,05	35,32	35,75	1,84	1,62	0,43	37,115	37,157	37,051	37,316
M 40	1,50	39,03	38,16	38,38	0,92	0,81	0,22	39,074	39,106	39,026	39,226
M 40	2,00	38,70	37,55	37,84	1,23	1,08	0,29	38,754	38,791	38,701	38,925
M 40	3,00	38,05	36,32	36,75	1,84	1,62	0,43	38,115	38,157	38,051	38,316
M 42	1,50	41,03	40,16	40,38	0,92	0,81	0,22	41,074	41,106	41,026	41,226
M 42	2,00	40,70	39,55	39,84	1,23	1,08	0,29	40,754	40,791	40,701	40,925
M 42	3,00	40,05	38,32	38,75	1,84	1,62	0,43	40,115	40,157	40,051	40,316
M 45	1,50	44,03	43,16	43,38	0,92	0,81	0,22	44,074	44,106	44,026	44,226
M 45	2,00	43,70	42,55	42,84	1,23	1,08	0,29	43,754	43,791	43,701	43,925
M 45	3,00	43,05	41,32	41,75	1,84	1,62	0,43	43,115	43,157	43,051	43,316

Nennmaße gemäß UNI 4535-64 / Nominal dimensions UNI 4535-64
 Fertigungstoleranzen Flankendurchmesser ISO 6H / Production tolerances on tap flank diameter for ISO 6H nut threads
 Grenzmaße-Muttergewinde nach ISO 6H / Limit dimensions-Nut threads ISO 6H

AGT

UNC Amerikanisches Zoll Gewinde / Unified coarse thread

H = 0.86603P		
H ₁ =	5 8	H = 0,54127P
h ₃ =	17 24	H = 0,61343P
d ₂ = D ₂ = d - H =	3 4	d - 0,64952P
d ₃ = d - 2h ₃ = d - 1,22687P		
r =	H 6	= 0,14434P

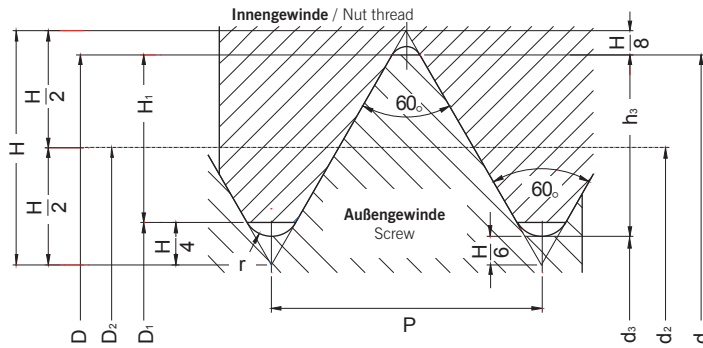

Gewinde Nominal diameter	T.P.I	Steigung Pitch	Flanken ø Pitch ø	Außen ø External ø	Kern ø Minor ø		Toleranz Gewindebohrer Tap tolerance 2B		Toleranz Innengewinde Nut tolerance 2B	
					Außengewinde Screw	Innengewinde Nut	Min	Max	Min	Max
d = D		P	d ₂ = D ₂	d = D	d ₃	D ₁	d ₂		D ₂	
UNC # 1	64	0,397	1,598	1,854	1,367	1,425	1,610	1,623	1,598	1,664
UNC # 2	64	0,454	1,890	2,184	1,628	1,694	1,902	1,915	1,890	1,961
UNC # 3	48	0,529	2,172	2,515	1,864	1,941	2,184	2,197	2,172	2,248
UNC # 4	40	0,635	2,433	2,845	2,065	2,156	2,446	2,459	2,433	2,517
UNC # 5	40	0,635	2,764	3,175	2,395	2,487	2,776	2,789	2,764	2,847
UNC # 6	32	0,794	2,990	3,505	2,532	2,647	3,105	3,028	2,990	3,084
UNC # 8	32	0,794	3,650	4,166	3,193	3,307	3,675	3,688	3,650	3,746
UNC # 10	24	1,058	4,138	4,826	3,528	3,680	4,163	4,176	4,138	4,247
UNC # 12	24	1,058	4,798	5,486	4,188	4,341	4,823	4,836	4,798	4,910
UNC 1/4"	20	1,270	5,524	6,350	4,793	4,976	5,575	5,588	5,524	5,646
UNC 5/16"	18	1,411	7,021	7,938	6,205	6,411	7,071	7,084	7,021	7,155
UNC 3/8"	16	1,588	8,494	9,525	7,577	7,805	8,545	8,557	8,494	8,639
UNC 7/16"	14	1,814	9,934	11,112	8,887	9,149	9,985	9,997	9,934	10,089
UNC 1/2"	13	1,954	11,430	12,700	10,302	10,584	11,481	11,494	11,430	11,595
UNC 9/16"	12	2,117	12,913	14,288	11,692	11,996	12,964	12,977	12,913	13,086
UNC 5/8"	11	2,309	14,376	15,875	13,043	13,376	14,427	14,440	14,376	14,559
UNC 3/4"	10	2,540	17,399	19,050	15,933	16,229	17,450	17,463	17,399	17,595
UNC 7/8"	9	2,822	20,391	22,225	18,763	19,169	20,455	20,467	20,391	20,599
UNC 1"	8	3,175	23,338	25,400	21,504	21,963	23,401	23,414	23,338	23,561
UNC 1 1/8"	7	3,629	26,218	28,575	24,122	24,648	26,294	26,319	26,218	26,457
UNC 1 1/4"	7	3,629	29,393	31,750	27,297	27,823	29,469	29,494	29,393	29,637
UNC 1 3/8"	6	4,233	32,174	34,925	29,731	30,343	32,250	32,276	32,174	32,438
UNC 1 1/2"	6	4,233	35,349	38,100	32,906	33,518	35,425	35,451	35,349	35,616
UNC 1 3/4"	5	5,080	41,151	44,450	38,217	38,951	41,241	41,266	41,151	41,445
UNC 2"	4,5	5,644	47,135	50,800	43,876	44,689	47,235	47,260	47,135	47,450
UNC 2 1/4"	4,5	5,644	53,485	57,150	50,226	51,039	-	-	53,485	53,805
UNC 2 1/2"	4	6,350	59,375	63,500	55,710	56,627	-	-	59,375	59,718
UNC 2 3/4"	4	6,350	65,725	69,850	62,060	62,977	-	-	65,725	66,073
UNC 3"	4	6,350	72,075	76,200	68,410	69,327	-	-	72,075	72,428
UNC 3 1/4"	4	6,350	78,425	82,550	74,760	75,677	-	-	78,425	78,783
UNC 3 1/2"	4	6,350	84,775	88,900	81,110	82,027	-	-	84,775	85,183
UNC 3 3/4"	4	6,350	91,125	95,250	87,460	88,377	-	-	91,125	91,493
UNC 4"	4	6,350	97,475	101,600	93,810	94,727	-	-	97,475	97,848

Nennmaße gemäß ANSI B1.1 / Nominal dimensions as per ANSI B1.1
 Fertigungstoleranzen Flankendurchmesser nach Klasse 2B / Production tolerances on tap flank diameter for 2B class nut threads
 Grenzmaße-Muttergewinde nach ANSI B1.1, Toleranzklassen 2B / Limit dimensions-Nut threads as per ANSI B1.1, 2B-3B tolerance classes

UNF Amerikanisches Zoll Feingewinde / Unified fine thread

H = 0.86603P		
H ₁ =	5 8	H = 0,54127P
h ₃ =	17 24	H = 0,61343P
d ₂ = D ₂ = d - H =	3 4	d - 0,64952P
d ₃ = d - 2h ₃ = d - 1,22687P		
r =	H 6	= 0,14434P

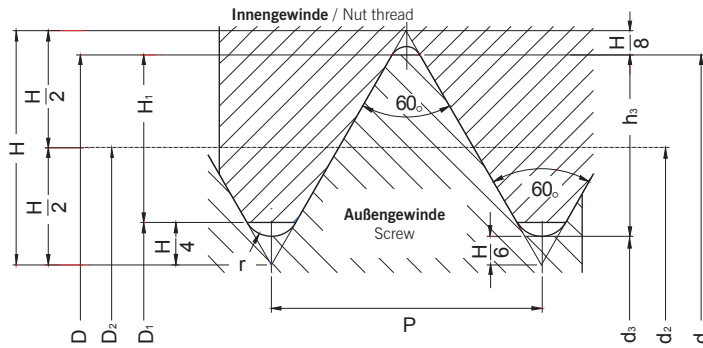

Gewinde Nominal diameter	T.P.I	Steigung Pitch	Flanken ø Pitch ø	Außen ø External ø	Kern ø Minor ø		Toleranz Gewindebohrer Tap tolerance 2B		Toleranz Innengewinde Nut tolerance 2B	
					Außengewinde Screw	Innengewinde Nut	Min	Max	Min	Max
d = D		P	d ₂ = D ₂	d = D	d ₃	D ₁	d ₂		D ₂	
UNF # 0	80	0,318	1,318	1,524	1,135	1,181	1,331	1,344	1,318	1,377
UNF # 1	72	0,353	1,626	1,854	1,422	1,473	1,638	1,651	1,626	1,689
UNF # 2	64	0,397	1,928	2,184	1,697	1,755	1,941	1,953	1,928	1,996
UNF # 3	56	0,454	2,220	2,515	1,958	2,024	2,233	2,245	2,220	2,291
UNF # 4	48	0,529	2,502	2,845	2,195	2,271	2,515	2,527	2,502	2,581
UNF # 5	44	0,577	2,799	3,175	2,466	2,550	2,812	2,824	2,799	2,880
UNF # 6	40	0,635	3,094	3,505	2,725	2,817	3,108	3,119	3,094	3,180
UNF # 8	36	0,706	3,708	4,166	3,299	3,401	3,721	3,734	3,708	3,800
UNF # 10	32	0,794	4,310	4,826	3,853	3,967	4,336	4,348	4,310	4,409
UNF # 12	28	0,907	4,897	5,486	4,374	4,503	4,923	4,935	4,897	5,004
UNF 1/4"	28	0,907	5,761	6,350	5,237	5,367	5,799	5,812	5,761	5,870
UNF 5/16"	24	1,058	7,249	7,938	6,640	6,792	7,287	7,300	7,249	7,371
UNF 3/8"	24	1,058	8,837	9,525	8,227	8,379	8,875	8,887	8,837	8,961
UNF 7/16"	20	1,270	10,287	11,112	9,555	9,738	10,338	10,351	10,287	10,424
UNF 1/2"	20	1,270	11,874	12,700	11,143	11,326	11,925	11,938	11,874	12,017
UNF 9/16"	18	1,411	13,371	14,288	12,555	12,761	13,421	13,434	13,371	13,520
UNF 5/8"	18	1,411	14,958	15,875	14,143	14,348	15,009	15,022	14,958	15,110
UNF 3/4"	16	1,588	18,019	19,050	17,102	17,330	18,070	18,082	18,019	18,184
UNF 7/8"	14	1,814	21,046	22,225	20,000	20,262	21,110	21,123	21,046	21,224
UNF 1"	12	2,117	24,026	25,400	22,804	23,109	24,089	24,102	24,026	24,219
UNF 1 1/8"	12	2,117	27,201	28,575	25,979	26,284	27,252	27,277	27,201	27,339
UNF 1 1/4"	12	2,117	30,376	31,750	29,154	29,459	30,427	30,452	30,376	30,579
UNF 1 3/8"	12	2,117	33,551	34,925	32,329	32,634	33,602	33,627	33,551	33,759
UNF 1 1/2"	12	2,117	36,726	38,100	35,504	35,809	36,777	36,802	36,726	36,937

Nennmaße gemäß ANSI B1.1 / Nominal dimensions as per ANSI B1.1
 Fertigungstoleranzen Flankendurchmesser nach Klasse 2B / Production tolerances on tap flank diameter for 2B class nut threads
 Grenzmaße-Muttergewinde nach ANSI B1.1, Toleranzklassen 2B / Limit dimensions-Nut threads as per ANSI B1.1, 2B-3B tolerance classes

Probleme und Abhilfe / Trouble shooting

Problem	Ursache / Possible reason	Mögliche Abhilfe / Possible solution
Gewinde zu groß Tapped hole oversize	Falscher Gewindebohrer im Einsatz (Schneidengeometrie ungeeignet). Incorrect tap in use (cutting geometry unsuitable for application).	Einen für den Werkstoff geeigneten Gewindebohrer auswählen. Use tap selected from the relevant material group.
	Flucht falsch. Faulty alignment.	Gewindebohrer und Kernloch müssen axial genau fluchten. Ensure that the tap is correctly aligned with the core hole axis.
	Kaltaufschweißung. Cold welding.	Schmierung und Ausrichtung des Kühlmittelstrahls verbessern. Schnittgeschwindigkeit korrigieren. Improve lubrication and direction of coolant. Adjust cutting speed.
	Anschnitt nicht konzentrisch (bei nachgeschärftem Gewindebohrer). Re-ground tap (lead-in is not concentric).	Anschnitt fehlerfrei auf geeigneter Schleifmaschine nachschleifen. Regrind tap lead correctly on a suitable tap grinding machine.
Gewinde verschnitten Stripped threads	Falscher Gewindebohrer im Einsatz (Schneidengeometrie ungeeignet). Incorrect tap in use (cutting geometry incorrect for application).	Einen für den Werkstoff geeigneten Gewindebohrer auswählen. Use a tap from the relevant material group.
	Spindelgeschwindigkeit und Vorschub sind nicht aufeinander abgestimmt. Spindle speed and feed rate not synchronized.	Vorschub und/oder Steigung der Spindel überprüfen. Gewindegewindespindel mit axialem Ausgleich verwenden. Check feed rate programming and/or pitch of leading spindle. Use a tapping spindle with axial float.
	Unzureichender Startdruck auf einen Gewindebohrer mit Schälanchnitt. Insufficient start pressure exerted on tap with peel-cut.	Startdruck erhöhen. Increase start pressure.
Gewinde trichterförmig Bell mouthed tapped hole	Falscher Gewindebohrer im Einsatz (Schneidengeometrie ungeeignet). Incorrect start pressure applied to tap (cutting geometry unsuitable for application).	Einen geeigneten Gewindebohrer auswählen. Use a tapping spindle with axial float.
Schlechte Gewindeoberfläche Unsatisfactory thread surface finish	Falscher Gewindebohrer im Einsatz (Schneidengeometrie ungeeignet). Incorrect tap in use (Cutting geometry unsuitable for application).	Einen für den Werkstoff geeigneten Gewindebohrer auswählen. Select tap from the relevant material group.
	Die Schneiden sind stumpf. The tap is blunt.	Neuen oder nachgeschärften Gewindebohrer einsetzen. Replace or regrind tap.
	Der Gewindebohrer ist schlecht nachgeschärft. Tap badly re-ground.	Gewindebohrer korrekt nachschleifen. Prüfen, ob die Schneidengeometrie für den Werkstoff geeignet ist. Re-grind tap again. Check that the cutting geometry is suitable for material.
	Kühlmittel mit unzureichendem Schmiermittelanteil. Coolant lacking in lubricating qualities and/or quantity.	Für qualitativ u. quantitativ gute Kühlung und Schmierung sorgen. Ensure the use of suitable coolant and an ample supply.
Gewinde ist unfertig Partial chipping of tap	Spänestau. Swarf jamming.	Schnittgeschwindigkeit prüfen. Anderen Gewindebohrertyp wählen. Check cutting speed. Use alternative tap type.
	Gewindebohrer ist auf den Grund des Kernlochs gefahren. Tap has jammed against bottom of core hole.	Kernlochtiefe und Gewindelänge prüfen. Kernloch tiefer bohren. Check hole and thread depths. Drill core hole deeper.
	Gewindebohrer ist schlecht nachgeschärft (Anschnitt-durchmesser zu klein, deshalb zu wenige schneidende Zähne). Tap incorrectly re-ground (lead-in diameter too small therefore too few cutting teeth).	Beim Nachschärfen auf Geometrie achten. Ensure that original values are maintained when regrinding.
	Materialfehler im Werkstück. Irregular workpiece material structure.	Schnittgeschwindigkeit anpassen. Die Schmierfähigkeit des Kühlmittels verbessern. Adjust cutting speed. Improve lubricating quality of coolant.
	Falsche Schnittgeschwindigkeit. Incorrect cutting speed.	Schnittgeschwindigkeit dem Werkstoff anpassen. Adjust cutting speed to suit workpiece material.
Übermäßiger Verschleiß des Gewindebohrers Excessive tap wear	Kühlmittel in unzureichender Schmierqualität oder Menge. Coolant lacking in lubricating qualities and/or quantity.	Für qualitativ und quantitativ gute Kühlung und Schmierung sorgen. Prüfen, ob das Kühlmittel den Schnittbereich erreicht. Ensure the use of a suitable coolant and an ample supply. Check that coolant is reaching the cutting zone.
	Verfestigte Bohrungswand des Kernlochs. Surface of the core hole is compacted.	Einsatzwerte beim Kernlochbohren prüfen (vorsichtig bohren um eine Aufhärtung der Bohrungswand zu vermeiden). Bohrerschneiden überprüfen. Check core hole drilling conditions (drill carefully to reduce risk of surface compacting). Check drill cutting edges.
	Falscher Gewindebohrer im Einsatz (Schneidengeometrie ungeeignet). Incorrect tap in use (cutting geometry unsuitable for application).	Einen für den Werkstoff geeigneten Gewindebohrer auswählen. Use tap from the relevant material group.
Bruch des Gewindebohrers Tap breakage	Fehlerhafte Fluchtung. Centering error.	Gewindebohrer und Kernloch müssen axial genau fluchten. Ensure that axes of tap and core hole are aligned.
	Schneiden sind stumpf. Blunt tap.	Neuen oder nachgeschärften Gewindebohrer einsetzen. Re-grind tap. Ensure that taps are stored carefully.
	Gewindebohrer ist auf den Grund des Kernlochs gefahren. Tap has reached bottom of core hole .	Gewindegewindespindel mit axialem Ausgleich und Rutschkupplung verwenden. Use tapping spindle with axial float and slipping clutch.
	Kernloch ist zu klein. Core hole too small.	Kernloch Durchmesser aus der Tabelle S. 383 – 384 auswählen. Select core hole as per chart, pages 383 - 384 of this catalogue.

Weitere Highlights unserer Frässysteme.

Other highlights from our milling range.

ARNO®-Frässystem DUO-MILL

Eckfräsen und HFC-Fräsen mit nur einem Werkzeug.



ARNO® milling-system DUO-MILL

Square shoulder and high feed (HFC) milling with just one tool.

ARNO®-Frässystem FTA

Der universelle Planfräser zur Kostenreduzierung.



ARNO® milling-system FTA

Face milling tool for cost reduction.

ARNO®-Frässystem FOA

Der positiv weichschneidende Planfräser, der eine Rundplatte und eine oktagonale Wendschneidplatte in einem Plattensitz vereint.



ARNO® milling-system FOA

The positive face-milling-cutter, in which both a round and an octagonal insert can be used.

Informationen zu diesen Produkten finden Sie unter www.arno.de oder direkt bei ARNO®.

For more information on these products please see our website www.arno.de or contact ARNO®.

ARNO®
WERKZEUGE

Weitere Informationen finden Sie unter:
For more information see:

www.arno.de

ARNO[®]

WERKZEUGE

We have a passion for precision.

VHM- UND PM-HSS-NC-ENTGRATER

PM and HSS deburring cutters

Ausführung

- AE - 4 Schneiden, 60°
- 4 Schneiden, 90°
- 4 Schneiden, 120°

Design

- AE - 4 flutes, 60°
- 4 flutes, 90°
- 4 flutes, 120°



Bezeichnung Description	Schneiden Flutes	Fräsertyp Type	Ausführung Design	Spiralwinkel Helix angle	Abb. Picture	Seite Page
AE - VHM NC-Entgrater / Solid carbide deburring cutter						
AE63041-...	4	VHM NC-Entgrater Solid carbide deburring cutter	kurz short	60°		396
AE63141-...	4	VHM NC-Entgrater Solid carbide deburring cutter	kurz short	90°		398
AE63241-...	4	VHM NC-Entgrater Solid carbide deburring cutter	kurz short	120°		400
AE - PM-HSS NC-Entgrater / Powder metal deburring cutter						
AE63041-...-PM	4	PM-HSS NC-Entgrater Powder metal deburring cutter	kurz short	60°		397
AE63141-...-PM	4	PM-HSS NC-Entgrater Powder metal deburring cutter	kurz short	90°		399
AE63241-...-PM	4	PM-HSS NC-Entgrater Powder metal deburring cutter	kurz short	120°		401

ARNO[®]

WERKZEUGE

We have a passion for precision.

AUSFÜHRUNG AE

Design AE

Schneller als die Konkurrenz.

Coated for speed.

Dank der TiAlN Beschichtung überzeugt der ARNO[®] Vollhartmetall NC-Entgrater durch eine um 50 % höhere Schnittgeschwindigkeit als ein unbeschichteter Entgrater. Er ist optimal für das Anfasen, Entgraten und Konturbearbeiten nahezu aller gängigen Werkstoffe geeignet. Auch MMS oder Trockenbearbeitung ist möglich.



Thanks to the TiAlN coating this NC-drill can be up to 50 % faster than the equivalent uncoated version. Suitable for nearly all materials. The tools can be used with micro lubrication coolant or run dry.

Vollhartmetall NC-Entgrater

4 Schneiden, 60°



Solid carbide deburring cutter

4 flutes, 60°



AE63041-....

Schaft / Shank	d	d _A	l	A
AE63041-040	4,00	4,00	54	60°
AE63041-060	6,00	6,00	54	60°
AE63041-080	8,00	8,00	58	60°
AE63041-100	10,00	10,00	66	60°
AE63041-120	12,00	12,00	73	60°

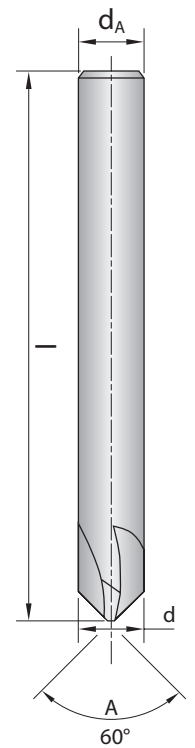

PM-HSS NC-Entgrater

4 Schneiden, 60°



Powder metal deburring cutter

4 flutes, 60°

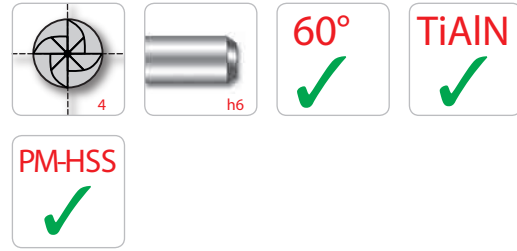

AE63041-...-PM

Schaft / Shank	d	d _A	l	A
AE63041-040-PM	4,00	4,00	54	60°
AE63041-060-PM	6,00	6,00	54	60°
AE63041-080-PM	8,00	8,00	58	60°
AE63041-100-PM	10,00	10,00	66	60°
AE63041-120-PM	12,00	12,00	73	60°

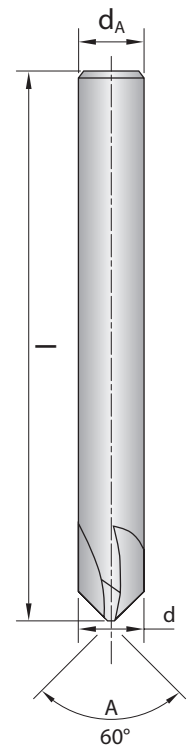

Vollhartmetall NC-Entgrater

4 Schneiden, 90°



Solid carbide deburring cutter

4 flutes, 90°



AE63141-...

Schaft / Shank	d	d _A	l	A
AE63141-040	4,00	4,00	54	90°
AE63141-060	6,00	6,00	54	90°
AE63141-080	8,00	8,00	58	90°
AE63141-100	10,00	10,00	66	90°
AE63141-120	12,00	12,00	73	90°

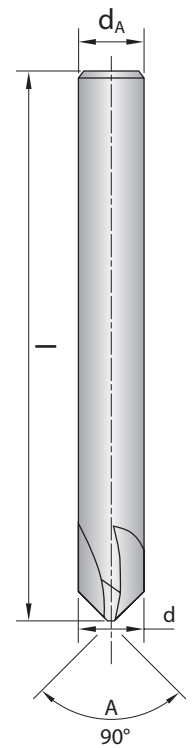

PM-HSS NC-Entgrater

4 Schneiden, 90°



Powder metal deburring cutter

4 flutes, 90°

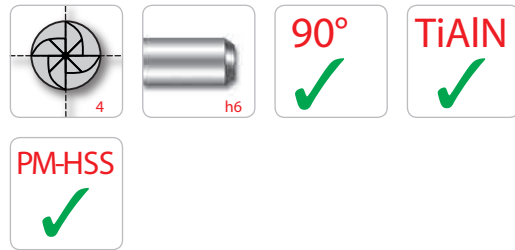

AE63141-...-PM

Schaft / Shank	d	d _A	l	A
AE63141-040-PM	4,00	4,00	54	90°
AE63141-060-PM	6,00	6,00	54	90°
AE63141-080-PM	8,00	8,00	58	90°
AE63141-100-PM	10,00	10,00	66	90°
AE63141-120-PM	12,00	12,00	73	90°

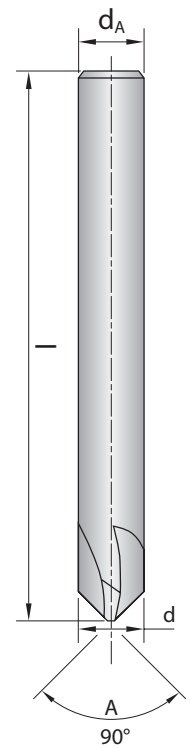

Vollhartmetall NC-Entgrater

4 Schneiden, 120°



Solid carbide deburring cutter

4 flutes, 120°



AE63241-....

Schaft / Shank	d	d _A	l	A
AE63241-040	4,00	4,00	54	120°
AE63241-060	6,00	6,00	54	120°
AE63241-080	8,00	8,00	58	120°
AE63241-100	10,00	10,00	66	120°
AE63241-120	12,00	12,00	73	120°

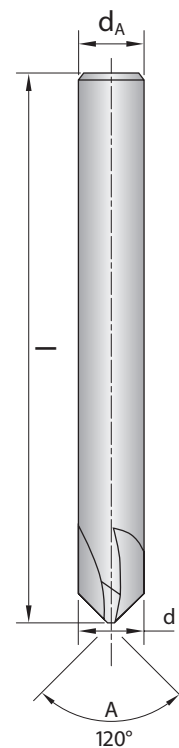

PM-HSS NC-Entgrater

4 Schneiden, 120°



Powder metal deburring cutter

4 flutes, 120°



AE63241-....-PM

Schaft / Shank	d	d _A	l	A
AE63241-040-PM	4,00	4,00	54	120°
AE63241-060-PM	6,00	6,00	54	120°
AE63241-080-PM	8,00	8,00	58	120°
AE63241-100-PM	10,00	10,00	66	120°
AE63241-120-PM	12,00	12,00	73	120°

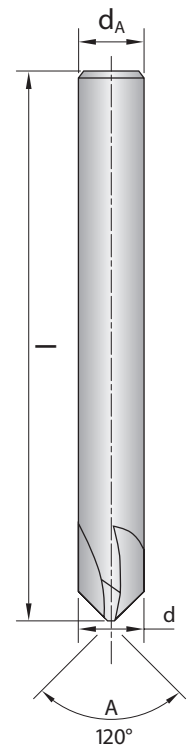

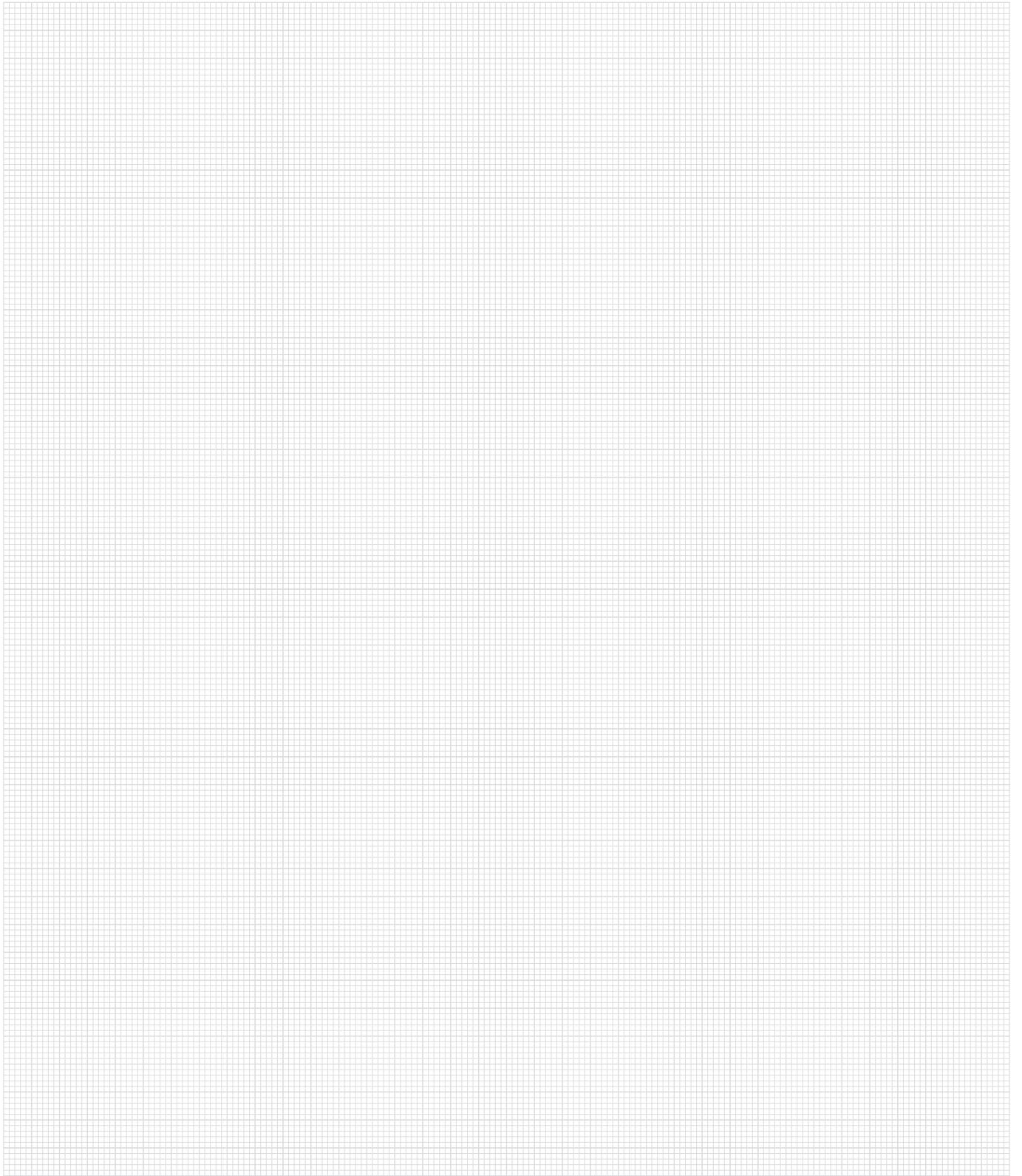

ARNO[®]
WERKZEUGE

Weitere Informationen finden Sie unter:
For more information see:

www.arno.de

ARNO[®]

WERKZEUGE

We have a passion for precision.

VHM- UND PM-HSS-SPIRALBOHRER

Solid carbide and PM-HSS drills

Ausführung











- SP - 3 x D
- 3 x D für Aluminium
- 3 x D für rostfreie Stähle
- 3 x D PM-HSS Spiralbohrer
- 5 x D
- 5 x D für Aluminium
- 5 x D für rostfreie Stähle
- 5 x D für gehärtete Stähle
- 7 x D
- 7 x D PM-HSS Spiralbohrer
- 8 x D
- 8 x D für Aluminium
- 8 x D für rostfreie Stähle
- 10 x D
- 15 x D
- 20 x D
- 25 x D
- 30 x D
- NC-Anbohrer, 4 Schneiden, 90°, 120° und 135°
- Zentrierbohrer









Design

- SP - 3 x D
- 3 x D for aluminium
- 3 x D for stainless steel
- 3 x D powder metal drill
- 5 x D
- 5 x D for aluminium
- 5 x D for stainless steel
- 5 x D for hardened steel
- 7 x D
- 7 x D powder metal drill
- 8 x D
- 8 x D for aluminium
- 8 x D for stainless steel
- 10 x D
- 15 x D
- 20 x D
- 25 x D
- 30 x D
- NC spot drills, 4 flutes, 90°, 120° and 135°
- Centre drills



Ausführung Design	Bohrertyp Type	Innenkühlung Through tool coolant	Durchmesser Diameter [mm]	Abb. Picture	Seite Page
3xD					
3xD	Vollhartmetall-Spiralbohrer Solid carbide drill	X	1,0 - 10,0		408
3xD	Vollhartmetall-Spiralbohrer Solid carbide drill	X	1,0 - 20,0		410
3xD	Vollhartmetall-Spiralbohrer Solid carbide drill	✓	3,0 - 20,0		412
3xD	Vollhartmetall-Spiralbohrer Solid carbide drill für Aluminium / for aluminium diamant beschichtet / diamond coated	✓	3,0 - 20,0		414
3xD	Vollhartmetall-Spiralbohrer Solid carbide drill für rostfreie Stähle / for stainless steel	✓	3,0 - 20,0		416
3xD	PM-HSS-Spiralbohrer Powder metal drill	X	1,0 - 13,3		418
5xD					
5xD	Vollhartmetall-Spiralbohrer Solid carbide drill	X	1,0 - 20,0		420
5xD	Vollhartmetall-Spiralbohrer Solid carbide drill	✓	1,0 - 20,0		422
5xD	Vollhartmetall-Spiralbohrer Solid carbide drill für Aluminium / for aluminium diamant beschichtet / diamond coated	✓	3,0 - 20,0		424
5xD	Vollhartmetall-Spiralbohrer Solid carbide drill für rostfreie Stähle / for stainless steel	✓	1,5 - 20,0		426
5xD	Vollhartmetall-Spiralbohrer Solid carbide drill für gehärtete Stähle / for hardened steel	X	3,0 - 14,0		428

Ausführung Design	Bohrertyp Type	Innenkühlung Through tool coolant	Durchmesser Diameter [mm]	Abb. Picture	Seite Page
7xD					
7xD	Vollhartmetall-Spiralbohrer Solid carbide drill unbeschichtet/ uncoated	X	1,0 - 10,0		430
7xD	NEU NEW Vollhartmetall-Spiralbohrer Solid carbide drills	X	1,0 - 10,0		432
7xD	PM-HSS Spiralbohrer Powder metal drills	X	2,0 - 13,0		434
8xD					
8xD	Vollhartmetall-Spiralbohrer Solid carbide drill	✓	3,0 - 12,0		436
8xD	Vollhartmetall-Spiralbohrer Solid carbide drill für Aluminium / for aluminium diamant beschichtet / diamond coated	✓	3,0 - 14,0		438
8xD	Vollhartmetall-Spiralbohrer Solid carbide drill für rostfreie Stähle / for stainless steel	✓	3,0 - 14,0		440
10xD					
10xD	NEU NEW Vollhartmetall-Spiralbohrer Solid carbide drill	✓	3,0 - 14,0		442
15xD					
15xD	NEU NEW Vollhartmetall-Spiralbohrer Solid carbide drill	✓	3,0 - 12,0		443
20xD					
20xD	NEU NEW Vollhartmetall-Spiralbohrer Solid carbide drill	✓	3,0 - 12,0		444
25xD					
25xD	NEU NEW Vollhartmetall-Spiralbohrer Solid carbide drill	✓	12,0 - 50,0		445

Ausführung Design	Bohrertyp Type	Innenkühlung Through tool coolant	Durchmesser Diameter [mm]	Abb. Picture	Seite Page
30xD					
30xD NEU NEW	Vollhartmetall-Spiralbohrer Solid carbide drill	✓	8,0 - 32,0		446
Anbohrer und Zentrierer / Spot drills and centre drills					
Anbohrer/ Spot drills	Vollhartmetall NC-Anbohrer 90° Solid carbide NC spot drills 90°	✗	2,0 - 20,0		447
Anbohrer/ Spot drills	Vollhartmetall NC-Anbohrer 120° Solid carbide NC spot drills 120°	✗	2,0 - 20,0		448
Anbohrer/ Spot drills NEU NEW	Vollhartmetall NC-Anbohrer 135° Solid carbide NC spot drills 135°	✗	2,0 - 20,0		449
Anbohrer/ Spot drills	PM-HSS NC-Anbohrer 90° Powder metal NC spot drills 90°	✗	2,0 - 20,0		450
Anbohrer/ Spot drills	PM-HSS NC-Anbohrer 120° Powder metal NC spot drills 120°	✗	2,0 - 20,0		451
Anbohrer/ Spot drills NEU NEW	PM-HSS NC-Anbohrer 135° Powder metal NC spot drills 135°	✗	2,0 - 20,0		452
Zentrierer/ centre drills	Vollhartmetall Zentrierer Solid carbide centre drills	✗	1,0 - 6,3		453
Zentrierer/ centre drills	PM-HSS Zentrierer Powder metal centre drills °	✗	1,0 - 6,3		454

ARNO®

WERKZEUGE

We have a passion for precision.

AUSFÜHRUNG SP

Design SP

Vollhartmetall und PM-HS Spiralbohrer. Höchste Präzision beim Bohren nahezu aller gängigen Werkstoffe.

Carbide and powder metal drills to cover all materials.

Durch ihre spezielle Konstruktion liefern die VHM-Bohrer nicht nur beste Ergebnisse beim Hochgeschwindigkeitsbohren sondern auch bei der Bohrungsqualität und Genauigkeit. Speziell entwickelte Schneidengeometrien und Spankammern sorgen für optimale Spanabfuhr und hervorragenden Spanbruch.

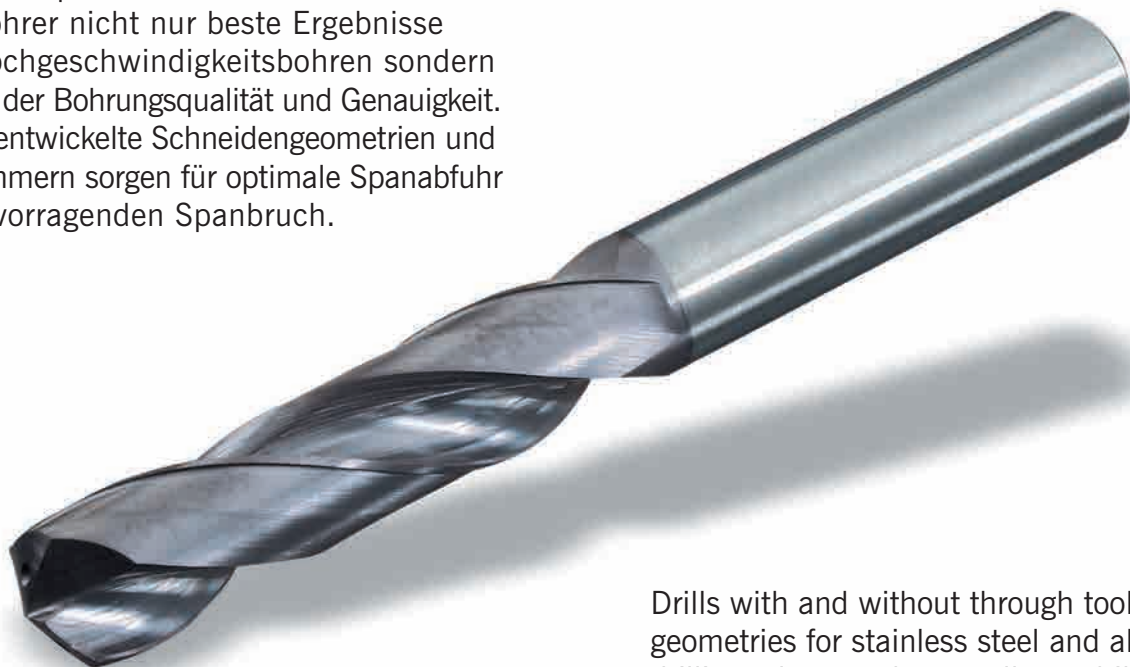

Drills with and without through tool coolant, geometries for stainless steel and aluminium drilling, also powder metallurgy drills for difficult applications.

Vollhartmetall-Spiralbohrer

Kurze Ausführung, ohne Innenkühlung

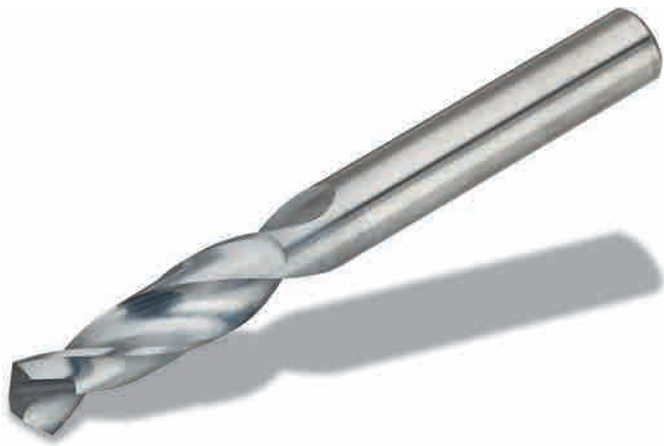

Solid carbide drills

Short design, without through tool coolant

h6	HA	1,0-10,0 mm	ohne IK without ic	Seite Page 455-462
118°	30°	h7	Unbeschichtet Uncoated	Feinstkorn Ultra micro granulation

Ausführung 3 x D / Execution 3 x D

Bezeichnung Designation	D h7	d _A h6	l	l ₂	l ₄
SP0100-0030 VHM/FK	1,00	1,00	26,0	6	3,00
SP0110-0033 VHM/FK	1,10	1,10	28,0	7	3,30
SP0120-0036 VHM/FK	1,20	1,20	30,0	8	3,60
SP0130-0039 VHM/FK	1,30	1,30	30,0	8	3,90
SP0140-0042 VHM/FK	1,40	1,40	32,0	9	4,20
SP0150-0045 VHM/FK	1,50	1,50	32,0	9	4,50
SP0160-0048 VHM/FK	1,60	1,60	34,0	10	4,80
SP0170-0051 VHM/FK	1,70	1,70	34,0	10	5,10
SP0180-0054 VHM/FK	1,80	1,80	36,0	11	5,40
SP0190-0057 VHM/FK	1,90	1,90	36,0	11	5,70
SP0200-0060 VHM/FK	2,00	2,00	38,0	12	6,00
SP0210-0063 VHM/FK	2,10	2,10	38,0	12	6,30
SP0220-0066 VHM/FK	2,20	2,20	40,0	13	6,60
SP0230-0069 VHM/FK	2,30	2,30	40,0	13	6,90
SP0240-0072 VHM/FK	2,40	2,40	43,0	14	7,20
SP0250-0075 VHM/FK	2,50	2,50	43,0	14	7,50
SP0260-0078 VHM/FK	2,60	2,60	43,0	14	7,80
SP0270-0081 VHM/FK	2,70	2,70	46,0	16	8,10
SP0280-0084 VHM/FK	2,80	2,80	46,0	16	8,40
SP0290-0087 VHM/FK	2,90	2,90	46,0	16	8,70
SP0300-0090 VHM/FK	3,00	3,00	46,0	16	9,00
SP0310-0093 VHM/FK	3,10	3,10	49,0	18	9,30
SP0320-0096 VHM/FK	3,20	3,20	49,0	18	9,60
SP0330-0099 VHM/FK	3,30	3,30	49,0	18	9,90
SP0340-0102 VHM/FK	3,40	3,40	52,0	20	10,20
SP0350-0105 VHM/FK	3,50	3,50	52,0	20	10,50
SP0360-0108 VHM/FK	3,60	3,60	52,0	20	10,80
SP0370-0111 VHM/FK	3,70	3,70	52,0	20	11,10
SP0380-0114 VHM/FK	3,80	3,80	52,0	20	11,40
SP0390-0117 VHM/FK	3,90	3,90	55,0	22	11,70
SP0400-0120 VHM/FK	4,00	4,00	55,0	22	12,00
SP0410-0123 VHM/FK	4,10	4,10	55,0	22	12,30
SP0420-0126 VHM/FK	4,20	4,20	55,0	22	12,60
SP0430-0129 VHM/FK	4,30	4,30	58,0	24	12,90
SP0440-0132 VHM/FK	4,40	4,40	58,0	24	13,20
SP0450-0135 VHM/FK	4,50	4,50	58,0	24	13,50
SP0460-0138 VHM/FK	4,60	4,60	58,0	24	13,80
SP0470-0141 VHM/FK	4,70	4,70	58,0	24	14,10
SP0480-0144 VHM/FK	4,80	4,80	62,0	26	14,40
SP0490-0147 VHM/FK	4,90	4,90	62,0	26	14,70
SP0500-0150 VHM/FK	5,00	5,00	62,0	26	15,00
SP0510-0153 VHM/FK	5,10	5,10	62,0	26	15,30

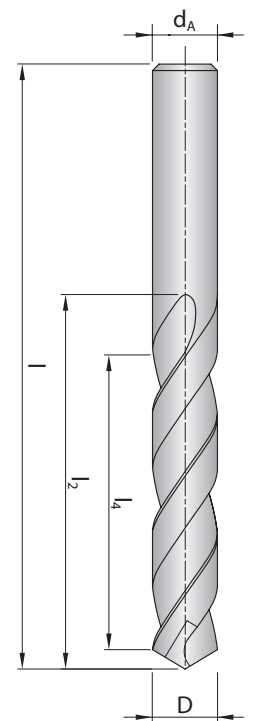

Vollhartmetall-Spiralbohrer

Kurze Ausführung, ohne Innenkühlung

Solid carbide drills

Short design, without through tool coolant

Ausführung 3 x D / Execution 3 x D

Bezeichnung Designation	D h7	d _A h6	l	l ₂	l ₄
SP0520-0156 VHM/FK	5,20	5,20	62,0	26	15,60
SP0530-0159 VHM/FK	5,30	5,30	62,0	26	15,90
SP0540-0162 VHM/FK	5,40	5,40	66,0	28	16,20
SP0550-0165 VHM/FK	5,50	5,50	66,0	28	16,50
SP0560-0168 VHM/FK	5,60	5,60	66,0	28	16,80
SP0570-0171 VHM/FK	5,70	5,70	66,0	28	17,10
SP0580-0174 VHM/FK	5,80	5,80	66,0	28	17,40
SP0590-0177 VHM/FK	5,90	5,90	66,0	28	17,70
SP0600-0180 VHM/FK	6,00	6,00	66,0	28	18,00
SP0610-0183 VHM/FK	6,10	6,10	70,0	31	18,30
SP0620-0186 VHM/FK	6,20	6,20	70,0	31	18,60
SP0630-0189 VHM/FK	6,30	6,30	70,0	31	18,90
SP0640-0192 VHM/FK	6,40	6,40	70,0	31	19,20
SP0650-0195 VHM/FK	6,50	6,50	70,0	31	19,50
SP0660-0198 VHM/FK	6,60	6,60	70,0	31	19,80
SP0670-0201 VHM/FK	6,70	6,70	70,0	31	20,10
SP0680-0204 VHM/FK	6,80	6,80	74,0	34	20,40
SP0690-0207 VHM/FK	6,90	6,90	74,0	34	20,70
SP0700-0210 VHM/FK	7,00	7,00	74,0	34	21,00
SP0710-0213 VHM/FK	7,10	7,10	74,0	34	21,30
SP0720-0216 VHM/FK	7,20	7,20	74,0	34	21,60
SP0730-0219 VHM/FK	7,30	7,30	74,0	34	21,90
SP0740-0222 VHM/FK	7,40	7,40	74,0	34	22,20
SP0750-0225 VHM/FK	7,50	7,50	74,0	34	22,50
SP0760-0228 VHM/FK	7,60	7,60	79,0	37	22,80
SP0770-0231 VHM/FK	7,70	7,70	79,0	37	23,10
SP0780-0234 VHM/FK	7,80	7,80	79,0	37	23,40
SP0790-0237 VHM/FK	7,90	7,90	79,0	37	23,70
SP0800-0240 VHM/FK	8,00	8,00	79,0	37	24,00
SP0810-0243 VHM/FK	8,10	8,10	79,0	37	24,30
SP0820-0246 VHM/FK	8,20	8,20	79,0	37	24,60
SP0830-0249 VHM/FK	8,30	8,30	79,0	37	24,90
SP0840-0252 VHM/FK	8,40	8,40	79,0	37	25,20
SP0850-0255 VHM/FK	8,50	8,50	79,0	37	25,50
SP0860-0258 VHM/FK	8,60	8,60	84,0	40	25,80
SP0870-0261 VHM/FK	8,70	8,70	84,0	40	26,10
SP0880-0264 VHM/FK	8,80	8,80	84,0	40	26,40
SP0890-0267 VHM/FK	8,90	8,90	84,0	40	26,70
SP0900-0270 VHM/FK	9,00	9,00	84,0	40	27,00
SP0910-0273 VHM/FK	9,10	9,10	84,0	40	27,30
SP0920-0276 VHM/FK	9,20	9,20	84,0	40	27,60
SP0930-0279 VHM/FK	9,30	9,30	84,0	40	27,90
SP0940-0282 VHM/FK	9,40	9,40	84,0	40	28,20
SP0950-0285 VHM/FK	9,50	9,50	84,0	40	28,50
SP0960-0288 VHM/FK	9,60	9,60	89,0	43	28,80
SP0970-0291 VHM/FK	9,70	9,70	89,0	43	29,10
SP0980-0294 VHM/FK	9,80	9,80	89,0	43	29,40
SP0990-0297 VHM/FK	9,90	9,90	89,0	43	29,70
SP1000-0300 VHM/FK	10,00	10,00	89,0	43	30,00

Vollhartmetall-Spiralbohrer

Kurze Ausführung, ohne Innenkühlung



Solid carbide drills

Short design, without through tool coolant

h6

HA

1,0-20,0 mm

ohne IK
without ic

Seite
Page
455-462

140°

30°

m7

TiAlN

Feinstkorn
Ultra micro
granulation

3
xD

Ausführung 3 x D / Execution 3 x D

Bezeichnung Designation	D m7	d _A h6	l	l ₂	l ₄
SP0100-0030 VHM/TIALN	1,00	3,00	45,0	7	3,00
SP0110-0033 VHM/TIALN	1,10	3,00	45,0	7	3,30
SP0120-0036 VHM/TIALN	1,20	3,00	45,0	7	3,60
SP0130-0039 VHM/TIALN	1,30	3,00	45,0	7	3,90
SP0140-0042 VHM/TIALN	1,40	3,00	45,0	7	4,20
SP0150-0045 VHM/TIALN	1,50	3,00	55,0	14	4,50
SP0160-0048 VHM/TIALN	1,60	3,00	55,0	14	4,80
SP0170-0051 VHM/TIALN	1,70	3,00	55,0	14	5,10
SP0180-0054 VHM/TIALN	1,80	3,00	55,0	14	5,40
SP0190-0057 VHM/TIALN	1,90	4,00	55,0	14	5,70
SP0200-0060 VHM/TIALN	2,00	4,00	55,0	20	6,00
SP0210-0063 VHM/TIALN	2,10	4,00	55,0	20	6,30
SP0220-0066 VHM/TIALN	2,20	4,00	55,0	20	6,60
SP0230-0069 VHM/TIALN	2,30	4,00	55,0	20	6,90
SP0240-0072 VHM/TIALN	2,40	4,00	55,0	20	7,20
SP0250-0075 VHM/TIALN	2,50	4,00	55,0	20	7,50
SP0260-0078 VHM/TIALN	2,60	4,00	55,0	20	7,80
SP0270-0081 VHM/TIALN	2,70	4,00	55,0	20	8,10
SP0280-0084 VHM/TIALN	2,80	4,00	55,0	20	8,40
SP0290-0087 VHM/TIALN	2,90	4,00	55,0	20	8,70
SP0300-0090 VHM/TIALN	3,00	6,00	62,0	20	9,00
SP0310-0093 VHM/TIALN	3,10	6,00	62,0	20	9,30
SP0320-0096 VHM/TIALN	3,20	6,00	62,0	20	9,60
SP0330-0099 VHM/TIALN	3,30	6,00	62,0	20	9,90
SP0340-0102 VHM/TIALN	3,40	6,00	62,0	20	10,20
SP0350-0105 VHM/TIALN	3,50	6,00	62,0	20	10,50
SP0360-0108 VHM/TIALN	3,60	6,00	62,0	20	10,80
SP0370-0111 VHM/TIALN	3,70	6,00	62,0	20	11,10
SP0380-0114 VHM/TIALN	3,80	6,00	66,0	24	11,40
SP0390-0117 VHM/TIALN	3,90	6,00	66,0	24	11,70
SP0400-0120 VHM/TIALN	4,00	6,00	66,0	24	12,00
SP0408-0122 VHM/TIALN	4,08	6,00	66,0	24	12,20
SP0410-0123 VHM/TIALN	4,10	6,00	66,0	24	12,30
SP0420-0126 VHM/TIALN	4,20	6,00	66,0	24	12,60
SP0425-0128 VHM/TIALN N	4,25	6,00	66,0	24	12,80
SP0430-0129 VHM/TIALN	4,30	6,00	66,0	24	12,90
SP0440-0132 VHM/TIALN	4,40	6,00	66,0	24	13,20
SP0450-0135 VHM/TIALN	4,50	6,00	66,0	24	13,50
SP0460-0138 VHM/TIALN	4,60	6,00	66,0	24	13,80
SP0470-0141 VHM/TIALN	4,70	6,00	66,0	24	14,10
SP0480-0144 VHM/TIALN	4,80	6,00	66,0	28	14,40
SP0490-0147 VHM/TIALN	4,90	6,00	66,0	28	14,70

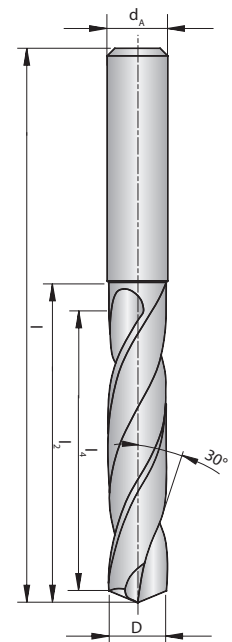

Vollhartmetall-Spiralbohrer

Kurze Ausführung, ohne Innenkühlung

Ausführung 3 x D / Execution 3 x D

Bezeichnung Designation	D m7	d _A h6	l	l ₂	l ₄
SP0497-0150 VHM/TIALN N	4,97	6,00	66,0	28	15,00
SP0500-0150 VHM/TIALN	5,00	6,00	66,0	28	15,00
SP0509-0153 VHM/TIALN	5,09	6,00	66,0	28	15,30
SP0510-0153 VHM/TIALN	5,10	6,00	66,0	28	15,30
SP0520-0156 VHM/TIALN	5,20	6,00	66,0	28	15,60
SP0530-0159 VHM/TIALN	5,30	6,00	66,0	28	15,90
SP0540-0162 VHM/TIALN	5,40	6,00	66,0	28	16,20
SP0550-0165 VHM/TIALN	5,50	6,00	66,0	28	16,50
SP0560-0168 VHM/TIALN	5,60	6,00	66,0	28	16,80
SP0570-0171 VHM/TIALN	5,70	6,00	66,0	28	17,10
SP0580-0174 VHM/TIALN	5,80	6,00	66,0	28	17,40
SP0590-0177 VHM/TIALN	5,90	6,00	66,0	28	17,70
SP0600-0180 VHM/TIALN	6,00	6,00	66,0	28	18,00
SP0609-0183 VHM/TIALN	6,09	8,00	79,0	34	18,30
SP0610-0183 VHM/TIALN	6,10	8,00	79,0	34	18,30
SP0620-0186 VHM/TIALN	6,20	8,00	79,0	34	18,60
SP0630-0189 VHM/TIALN	6,30	8,00	79,0	34	18,90
SP0640-0192 VHM/TIALN	6,40	8,00	79,0	34	19,20
SP0650-0195 VHM/TIALN	6,50	8,00	79,0	34	19,50
SP0655-0197 VHM/TIALN N	6,55	8,00	79,0	34	19,70
SP0660-0198 VHM/TIALN	6,60	8,00	79,0	34	19,80
SP0670-0201 VHM/TIALN	6,70	8,00	79,0	34	20,10
SP0680-0204 VHM/TIALN	6,80	8,00	79,0	34	20,40
SP0690-0207 VHM/TIALN	6,90	8,00	79,0	34	20,70
SP0700-0210 VHM/TIALN	7,00	8,00	79,0	34	21,00
SP0710-0213 VHM/TIALN	7,10	8,00	79,0	41	21,30
SP0720-0216 VHM/TIALN	7,20	8,00	79,0	41	21,60
SP0730-0219 VHM/TIALN	7,30	8,00	79,0	41	21,90
SP0740-0222 VHM/TIALN	7,40	8,00	79,0	41	22,20
SP0750-0225 VHM/TIALN	7,50	8,00	79,0	41	22,50
SP0760-0228 VHM/TIALN	7,60	8,00	79,0	41	22,80
SP0770-0231 VHM/TIALN	7,70	8,00	79,0	41	23,10
SP0780-0234 VHM/TIALN	7,80	8,00	79,0	41	23,40
SP0790-0237 VHM/TIALN	7,90	8,00	79,0	41	23,70
SP0800-0240 VHM/TIALN	8,00	8,00	79,0	41	24,00
SP0810-0243 VHM/TIALN	8,10	10,00	89,0	47	24,30
SP0820-0246 VHM/TIALN	8,20	10,00	89,0	47	24,60
SP0830-0249 VHM/TIALN	8,30	10,00	89,0	47	24,90
SP0840-0252 VHM/TIALN	8,40	10,00	89,0	47	25,20
SP0850-0255 VHM/TIALN	8,50	10,00	89,0	47	25,50
SP0860-0258 VHM/TIALN	8,60	10,00	89,0	47	25,80
SP0870-0261 VHM/TIALN	8,70	10,00	89,0	47	26,10
SP0880-0264 VHM/TIALN	8,80	10,00	89,0	47	26,40
SP0890-0267 VHM/TIALN	8,90	10,00	89,0	47	26,70
SP0900-0270 VHM/TIALN	9,00	10,00	89,0	47	27,00
SP0910-0273 VHM/TIALN	9,10	10,00	89,0	47	27,30
SP0920-0276 VHM/TIALN	9,20	10,00	89,0	47	27,60
SP0930-0279 VHM/TIALN	9,30	10,00	89,0	47	27,90
SP0940-0282 VHM/TIALN	9,40	10,00	89,0	47	28,20
SP0950-0285 VHM/TIALN	9,50	10,00	89,0	47	28,50
SP0960-0288 VHM/TIALN	9,60	10,00	89,0	47	28,80
SP0970-0291 VHM/TIALN	9,70	10,00	89,0	47	29,10
SP0980-0294 VHM/TIALN	9,80	10,00	89,0	47	29,40
SP0990-0297 VHM/TIALN	9,90	10,00	89,0	47	29,70
SP1000-0300 VHM/TIALN	10,00	10,00	89,0	47	30,00
SP1010-0303 VHM/TIALN	10,10	12,00	102,0	55	30,30
SP1020-0306 VHM/TIALN	10,20	12,00	102,0	55	30,60
SP1030-0309 VHM/TIALN	10,30	12,00	102,0	55	30,90

Solid carbide drills

Short design, without through tool coolant

Bezeichnung Designation	D m7	d _A h6	l	l ₂	l ₄
SP1040-0312 VHM/TIALN	10,40	12,00	102,0	55	31,20
SP1050-0315 VHM/TIALN	10,50	12,00	102,0	55	31,50
SP1060-0318 VHM/TIALN	10,60	12,00	102,0	55	31,80
SP1070-0321 VHM/TIALN	10,70	12,00	102,0	55	32,10
SP1080-0324 VHM/TIALN	10,80	12,00	102,0	55	32,40
SP1090-0327 VHM/TIALN	10,90	12,00	102,0	55	32,70
SP1100-0330 VHM/TIALN	11,00	12,00	102,0	55	33,00
SP1110-0333 VHM/TIALN	11,10	12,00	102,0	55	33,30
SP1120-0336 VHM/TIALN	11,20	12,00	102,0	55	33,60
SP1130-0339 VHM/TIALN	11,30	12,00	102,0	55	33,90
SP1140-0342 VHM/TIALN	11,40	12,00	102,0	55	34,20
SP1150-0345 VHM/TIALN	11,50	12,00	102,0	55	34,50
SP1160-0348 VHM/TIALN	11,60	12,00	102,0	55	34,80
SP1170-0351 VHM/TIALN	11,70	12,00	102,0	55	35,10
SP1180-0354 VHM/TIALN	11,80	12,00	102,0	55	35,40
SP1190-0357 VHM/TIALN	11,90	12,00	102,0	55	35,70
SP1200-0360 VHM/TIALN	12,00	12,00	102,0	55	36,00
SP1230-0369 VHM/TIALN	12,30	14,00	107,0	60	36,90
SP1250-0375 VHM/TIALN	12,50	14,00	107,0	60	37,50
SP1280-0384 VHM/TIALN	12,80	14,00	107,0	60	38,40
SP1300-0390 VHM/TIALN	13,00	14,00	107,0	60	39,00
SP1350-0405 VHM/TIALN	13,50	14,00	107,0	60	40,50
SP1380-0414 VHM/TIALN	13,80	14,00	107,0	60	41,40
SP1400-0420 VHM/TIALN	14,00	14,00	107,0	60	42,00
SP1450-0435 VHM/TIALN	14,50	16,00	115,0	65	43,50
SP1480-0444 VHM/TIALN	14,80	16,00	115,0	65	44,40
SP1500-0450 VHM/TIALN	15,00	16,00	115,0	65	45,00
SP1550-0465 VHM/TIALN	15,50	16,00	115,0	65	46,50
SP1580-0474 VHM/TIALN	15,80	16,00	115,0	65	47,40
SP1600-0480 VHM/TIALN	16,00	16,00	115,0	65	48,00
SP1650-0495 VHM/TIALN	16,50	18,00	123,0	73	49,50
SP1680-0504 VHM/TIALN	16,80	18,00	123,0	73	50,40
SP1700-0510 VHM/TIALN	17,00	18,00	123,0	73	51,00
SP1750-0525 VHM/TIALN	17,50	18,00	123,0	73	52,50
SP1780-0534 VHM/TIALN	17,80	18,00	123,0	73	53,40
SP1800-0540 VHM/TIALN	18,00	18,00	123,0	73	54,00
SP1850-0555 VHM/TIALN	18,50	20,00	131,0	79	55,50
SP1880-0564 VHM/TIALN	18,80	20,00	131,0	79	56,40
SP1900-0570 VHM/TIALN	19,00	20,00	131,0	79	57,00
SP1950-0585 VHM/TIALN	19,50	20,00	131,0	79	58,50
SP1980-0594 VHM/TIALN	19,80	20,00	131,0	79	59,40
SP2000-0600 VHM/TIALN	20,00	20,00	131,0	79	60,00

Vollhartmetall-Spiralbohrer

Kurze Ausführung, mit Innenkühlung



Solid carbide drills

Short design, with through tool coolant



h6



HAK



1,0-20,0 mm



mit IK
with ic



Seite
Page
455-462



140°

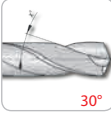

30°



m7



TiAlN



Feinstkorn
Ultra micro
granulation

3
xD

Ausführung 3 x D / Execution 3 x D

Bezeichnung Designation	D m7	d _A h6	l	l ₂	l ₄
SPC0100-0030 VHM/TIALN	1,00	3,00	45,0	7	3,00
SPC0110-0033 VHM/TIALN	1,10	3,00	45,0	7	3,30
SPC0120-0036 VHM/TIALN	1,20	3,00	45,0	7	3,60
SPC0130-0039 VHM/TIALN	1,30	3,00	45,0	7	3,90
SPC0140-0042 VHM/TIALN	1,40	3,00	45,0	7	4,20
SPC0150-0045 VHM/TIALN	1,50	3,00	55,0	14	4,50
SPC0160-0048 VHM/TIALN	1,60	3,00	55,0	14	4,80
SPC0170-0051 VHM/TIALN	1,70	3,00	55,0	14	5,10
SPC0180-0054 VHM/TIALN	1,80	3,00	55,0	14	5,40
SPC0190-0057 VHM/TIALN	1,90	3,00	55,0	14	5,70
SPC0200-0060 VHM/TIALN	2,00	4,00	55,0	20	6,00
SPC0210-0063 VHM/TIALN	2,10	4,00	55,0	20	6,30
SPC0220-0066 VHM/TIALN	2,20	4,00	55,0	20	6,60
SPC0230-0069 VHM/TIALN	2,30	4,00	55,0	20	6,90
SPC0240-0072 VHM/TIALN	2,40	4,00	55,0	20	7,20
SPC0250-0075 VHM/TIALN	2,50	4,00	55,0	20	7,50
SPC0258-00774 VHM/TIALN N	2,58	4,00	55,0	20	7,74
SPC0260-0078 VHM/TIALN	2,60	4,00	55,0	20	7,80
SPC0270-0081 VHM/TIALN	2,70	4,00	55,0	20	8,10
SPC0280-0084 VHM/TIALN	2,80	4,00	55,0	20	8,40
SPC0290-0087 VHM/TIALN	2,90	4,00	55,0	20	8,70
SPC0300-0090 VHM/TIALN	3,00	6,00	62,0	20	9,00
SPC0310-0093 VHM/TIALN	3,10	6,00	62,0	20	9,30
SPC0320-0096 VHM/TIALN	3,20	6,00	62,0	20	9,60
SPC0325-0098 VHM/TIALN	3,25	6,00	62,0	20	9,80
SPC0330-0099 VHM/TIALN	3,30	6,00	62,0	20	9,90
SPC0340-0102 VHM/TIALN	3,40	6,00	62,0	20	10,20
SPC0350-0105 VHM/TIALN	3,50	6,00	62,0	20	10,50
SPC0360-0108 VHM/TIALN	3,60	6,00	62,0	20	10,80
SPC0370-0111 VHM/TIALN	3,70	6,00	62,0	20	11,10
SPC0380-0114 VHM/TIALN	3,80	6,00	66,0	24	11,40
SPC0390-0117 VHM/TIALN	3,90	6,00	66,0	24	11,70
SPC0400-0120 VHM/TIALN	4,00	6,00	66,0	24	12,00
SPC0410-0123 VHM/TIALN	4,10	6,00	66,0	24	12,30
SPC0415-0125 VHM/TIALN	4,15	6,00	66,0	24	12,50
SPC0420-0126 VHM/TIALN	4,20	6,00	66,0	24	12,60
SPC0430-0129 VHM/TIALN	4,30	6,00	66,0	24	12,90
SPC0440-0132 VHM/TIALN	4,40	6,00	66,0	24	13,20
SPC0450-0135 VHM/TIALN	4,50	6,00	66,0	24	13,50
SPC0460-0138 VHM/TIALN	4,60	6,00	66,0	24	13,80
SPC0465-0140 VHM/TIALN	4,65	6,00	66,0	24	14,00
SPC0470-0141 VHM/TIALN	4,70	6,00	66,0	24	14,10

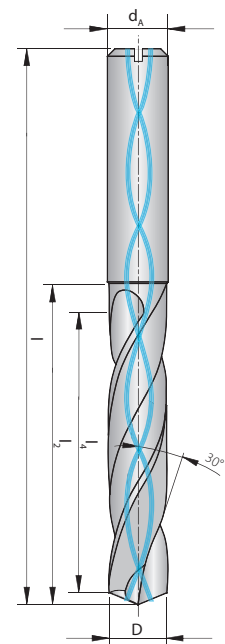

Vollhartmetall-Spiralbohrer

Kurze Ausführung, mit Innenkühlung

Ausführung 3 x D / Execution 3 x D

Bezeichnung Designation	D m7	d _A h6	l	l ₂	l ₄
SPC0480-0144 VHM/TIALN	4,80	6,00	66,0	28	14,40
SPC0490-0147 VHM/TIALN	4,90	6,00	66,0	28	14,70
SPC0500-0150 VHM/TIALN	5,00	6,00	66,0	28	15,00
SPC0510-0153 VHM/TIALN	5,10	6,00	66,0	28	15,30
SPC0520-0156 VHM/TIALN	5,20	6,00	66,0	28	15,60
SPC0530-0159 VHM/TIALN	5,30	6,00	66,0	28	15,90
SPC0540-0162 VHM/TIALN	5,40	6,00	66,0	28	16,20
SPC0550-0165 VHM/TIALN	5,50	6,00	66,0	28	16,50
SPC0555-0167 VHM/TIALN	5,55	6,00	66,0	28	16,70
SPC0560-0168 VHM/TIALN	5,60	6,00	66,0	28	16,80
SPC0570-0171 VHM/TIALN	5,70	6,00	66,0	28	17,10
SPC0580-0174 VHM/TIALN	5,80	6,00	66,0	28	17,40
SPC0590-0177 VHM/TIALN	5,90	6,00	66,0	28	17,70
SPC0600-0180 VHM/TIALN	6,00	6,00	66,0	28	18,00
SPC0610-0183 VHM/TIALN	6,10	8,00	79,0	34	18,30
SPC0620-0186 VHM/TIALN	6,20	8,00	79,0	34	18,60
SPC0630-0189 VHM/TIALN	6,30	8,00	79,0	34	18,90
SPC0640-0192 VHM/TIALN	6,40	8,00	79,0	34	19,20
SPC0650-0195 VHM/TIALN	6,50	8,00	79,0	34	19,50
SPC0655-0197 VHM/TIALN	6,55	8,00	79,0	34	19,70
SPC0660-0198 VHM/TIALN	6,60	8,00	79,0	34	19,80
SPC0670-0201 VHM/TIALN	6,70	8,00	79,0	34	20,10
SPC0680-0204 VHM/TIALN	6,80	8,00	79,0	34	20,40
SPC0690-0207 VHM/TIALN	6,90	8,00	79,0	34	20,70
SPC0700-0210 VHM/TIALN	7,00	8,00	79,0	34	21,00
SPC0710-0213 VHM/TIALN	7,10	8,00	79,0	41	21,30
SPC0720-0216 VHM/TIALN	7,20	8,00	79,0	41	21,60
SPC0730-0219 VHM/TIALN	7,30	8,00	79,0	41	21,90
SPC0740-0222 VHM/TIALN	7,40	8,00	79,0	41	22,20
SPC0745-0224 VHM/TIALN	7,45	8,00	79,0	41	22,40
SPC0750-0225 VHM/TIALN	7,50	8,00	79,0	41	22,50
SPC0760-0228 VHM/TIALN	7,60	8,00	79,0	41	22,80
SPC0770-0231 VHM/TIALN	7,70	8,00	79,0	41	23,10
SPC0780-0234 VHM/TIALN	7,80	8,00	79,0	41	23,40
SPC0790-0237 VHM/TIALN	7,90	8,00	79,0	41	23,70
SPC0800-0240 VHM/TIALN	8,00	8,00	79,0	41	24,00
SPC0810-0243 VHM/TIALN	8,10	10,00	89,0	47	24,30
SPC0820-0246 VHM/TIALN	8,20	10,00	89,0	47	24,60
SPC0830-0249 VHM/TIALN	8,30	10,00	89,0	47	24,90
SPC0840-0252 VHM/TIALN	8,40	10,00	89,0	47	25,20
SPC0850-0255 VHM/TIALN	8,50	10,00	89,0	47	25,50
SPC0860-0258 VHM/TIALN	8,60	10,00	89,0	47	25,80
SPC0870-0261 VHM/TIALN	8,70	10,00	89,0	47	26,10
SPC0880-0264 VHM/TIALN	8,80	10,00	89,0	47	26,40
SPC0890-0267 VHM/TIALN	8,90	10,00	89,0	47	26,70
SPC0900-0270 VHM/TIALN	9,00	10,00	89,0	47	27,00
SPC0910-0273 VHM/TIALN	9,10	10,00	89,0	47	27,30
SPC0920-0276 VHM/TIALN	9,20	10,00	89,0	47	27,60
SPC0925-0278 VHM/TIALN	9,25	10,00	89,0	47	27,80
SPC0930-0279 VHM/TIALN	9,30	10,00	89,0	47	27,90
SPC0940-0282 VHM/TIALN	9,40	10,00	89,0	47	28,20
SPC0950-0285 VHM/TIALN	9,50	10,00	89,0	47	28,50
SPC0960-0288 VHM/TIALN	9,60	10,00	89,0	47	28,80
SPC0970-0291 VHM/TIALN	9,70	10,00	89,0	47	29,10
SPC0980-0294 VHM/TIALN	9,80	10,00	89,0	47	29,40
SPC0990-0297 VHM/TIALN	9,90	10,00	89,0	47	29,70
SPC1000-0300 VHM/TIALN	10,00	10,00	89,0	47	30,00
SPC1010-0303 VHM/TIALN	10,10	12,00	102,0	55	30,30

Solid carbide drills

Short design, with through tool coolant

Bezeichnung Designation	D m7	d _A h6	l	l ₂	l ₄
SPC1020-0306 VHM/TIALN	10,20	12,00	102,0	55	30,60
SPC1025-0308 VHM/TIALN	10,25	12,00	102,0	55	30,80
SPC1030-0309 VHM/TIALN	10,30	12,00	102,0	55	30,90
SPC1040-0312 VHM/TIALN	10,40	12,00	102,0	55	31,20
SPC1050-0315 VHM/TIALN	10,50	12,00	102,0	55	31,50
SPC1060-0318 VHM/TIALN	10,60	12,00	102,0	55	31,80
SPC1070-0321 VHM/TIALN	10,70	12,00	102,0	55	32,10
SPC1080-0324 VHM/TIALN	10,80	12,00	102,0	55	32,40
SPC1090-0327 VHM/TIALN	10,90	12,00	102,0	55	32,70
SPC1100-0330 VHM/TIALN	11,00	12,00	102,0	55	33,00
SPC1110-0333 VHM/TIALN	11,10	12,00	102,0	55	33,30
SPC1120-0336 VHM/TIALN	11,20	12,00	102,0	55	33,60
SPC1130-0339 VHM/TIALN	11,30	12,00	102,0	55	33,90
SPC1140-0342 VHM/TIALN	11,40	12,00	102,0	55	34,20
SPC1150-0345 VHM/TIALN	11,50	12,00	102,0	55	34,50
SPC1160-0348 VHM/TIALN	11,60	12,00	102,0	55	34,80
SPC1170-0351 VHM/TIALN	11,70	12,00	102,0	55	35,10
SPC1180-0354 VHM/TIALN	11,80	12,00	102,0	55	35,40
SPC1190-0357 VHM/TIALN	11,90	12,00	102,0	55	35,70
SPC1200-0360 VHM/TIALN	12,00	12,00	102,0	55	36,00
SPC1250-0375 VHM/TIALN	12,50	14,00	107,0	60	37,50
SPC1280-0384 VHM/TIALN	12,80	14,00	107,0	60	38,40
SPC1300-0390 VHM/TIALN	13,00	14,00	107,0	60	39,00
SPC1310-0393 VHM/TIALN	13,10	14,00	107,0	60	39,30
SPC1350-0405 VHM/TIALN	13,50	14,00	107,0	60	40,50
SPC1380-0414 VHM/TIALN	13,80	14,00	107,0	60	41,40
SPC1400-0420 VHM/TIALN	14,00	14,00	107,0	60	42,00
SPC1420-0426 VHM/TIALN	14,20	16,00	115,0	65	42,60
SPC1450-0435 VHM/TIALN	14,50	16,00	115,0	65	43,50
SPC1500-0450 VHM/TIALN	15,00	16,00	115,0	65	45,00
SPC1510-0453 VHM/TIALN	15,10	16,00	115,0	65	45,30
SPC1550-0465 VHM/TIALN	15,50	16,00	115,0	65	46,50
SPC1580-0474 VHM/TIALN	15,80	16,00	115,0	65	47,40
SPC1600-0480 VHM/TIALN	16,00	16,00	115,0	65	48,00
SPC1650-0495 VHM/TIALN	16,50	18,00	123,0	73	49,50
SPC1680-0504 VHM/TIALN	16,80	18,00	123,0	73	50,40
SPC1690-0507 VHM/TIALN	16,90	18,00	123,0	73	50,70
SPC1700-0510 VHM/TIALN	17,00	18,00	123,0	73	51,00
SPC1750-0525 VHM/TIALN	17,50	18,00	123,0	73	52,50
SPC1780-0534 VHM/TIALN	17,80	18,00	123,0	73	53,40
SPC1800-0540 VHM/TIALN	18,00	18,00	123,0	73	54,00
SPC1850-0555 VHM/TIALN	18,50	20,00	131,0	73	55,50
SPC1880-0564 VHM/TIALN	18,80	20,00	131,0	79	56,40
SPC1890-0567 VHM/TIALN	18,90	20,00	131,0	79	56,70
SPC1900-0570 VHM/TIALN	19,00	20,00	131,0	79	57,00
SPC1950-0585 VHM/TIALN	19,50	20,00	131,0	79	58,50
SPC1980-0594 VHM/TIALN	19,80	20,00	131,0	79	59,40
SPC2000-0600 VHM/TIALN	20,00	20,00	131,0	79	60,00

Vollhartmetall-Spiralbohrer

Kurze Ausführung, mit Innenkühlung, Diamant beschichtet



Solid carbide drills

Short design, with through tool coolant, diamond coated

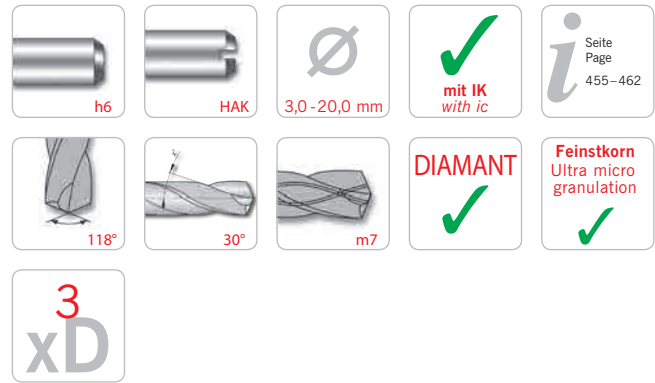

Ausführung 3 x D für Aluminium / Execution 3 x D for aluminium

Bezeichnung Designation	D m7	d _A h6	l	l ₂	l ₄
SPC0300-0090-ALU VHM/DLC	3,00	6,00	62,0	20	9,00
SPC0310-0093-ALU VHM/DLC	3,10	6,00	62,0	20	9,30
SPC0320-0096-ALU VHM/DLC	3,20	6,00	62,0	20	9,60
SPC0330-0099-ALU VHM/DLC	3,30	6,00	62,0	20	9,90
SPC0340-0102-ALU VHM/DLC	3,40	6,00	62,0	20	10,20
SPC0350-0105-ALU VHM/DLC	3,50	6,00	62,0	20	10,50
SPC0360-0108-ALU VHM/DLC	3,60	6,00	62,0	20	10,80
SPC0370-0111-ALU VHM/DLC	3,70	6,00	62,0	20	11,10
SPC0380-0114-ALU VHM/DLC	3,80	6,00	66,0	24	11,40
SPC0390-0117-ALU VHM/DLC	3,90	6,00	66,0	24	11,70
SPC0400-0120-ALU VHM/DLC	4,00	6,00	66,0	24	12,00
SPC0410-0123-ALU VHM/DLC	4,10	6,00	66,0	24	12,30
SPC0420-0126-ALU VHM/DLC	4,20	6,00	66,0	24	12,60
SPC0430-0129-ALU VHM/DLC	4,30	6,00	66,0	24	12,90
SPC0440-0132-ALU VHM/DLC	4,40	6,00	66,0	24	13,20
SPC0450-0135-ALU VHM/DLC	4,50	6,00	66,0	24	13,50
SPC0460-0138-ALU VHM/DLC	4,60	6,00	66,0	24	13,80
SPC0470-0141-ALU VHM/DLC	4,70	6,00	66,0	24	14,10
SPC0480-0144-ALU VHM/DLC	4,80	6,00	66,0	28	14,40
SPC0490-0147-ALU VHM/DLC	4,90	6,00	66,0	28	14,70
SPC0500-0150-ALU VHM/DLC	5,00	6,00	66,0	28	15,00
SPC0510-0153-ALU VHM/DLC	5,10	6,00	66,0	28	15,30
SPC0520-0156-ALU VHM/DLC	5,20	6,00	66,0	28	15,60
SPC0530-0159-ALU VHM/DLC	5,30	6,00	66,0	28	15,90
SPC0540-0162-ALU VHM/DLC	5,40	6,00	66,0	28	16,20
SPC0550-0165-ALU VHM/DLC	5,50	6,00	66,0	28	16,50
SPC0560-0168-ALU VHM/DLC	5,60	6,00	66,0	28	16,80
SPC0570-0171-ALU VHM/DLC	5,70	6,00	66,0	28	17,10
SPC0580-0174-ALU VHM/DLC	5,80	6,00	66,0	28	17,40
SPC0590-0177-ALU VHM/DLC	5,90	6,00	66,0	28	17,70
SPC0600-0180-ALU VHM/DLC	6,00	6,00	66,0	28	18,00
SPC0610-0183-ALU VHM/DLC	6,10	8,00	79,0	34	18,30
SPC0620-0186-ALU VHM/DLC	6,20	8,00	79,0	34	18,60
SPC0630-0189-ALU VHM/DLC	6,30	8,00	79,0	34	18,90
SPC0640-0192-ALU VHM/DLC	6,40	8,00	79,0	34	19,20
SPC0650-0195-ALU VHM/DLC	6,50	8,00	79,0	34	19,50
SPC0660-0198-ALU VHM/DLC	6,60	8,00	79,0	34	19,80
SPC0670-0201-ALU VHM/DLC	6,70	8,00	79,0	34	20,10
SPC0680-0204-ALU VHM/DLC	6,80	8,00	79,0	34	20,40
SPC0690-0207-ALU VHM/DLC	6,90	8,00	79,0	34	20,70
SPC0700-0210-ALU VHM/DLC	7,00	8,00	79,0	34	21,00
SPC0710-0213-ALU VHM/DLC	7,10	8,00	79,0	41	21,30

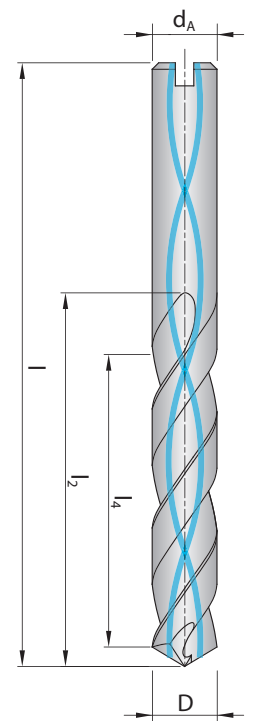

Vollhartmetall-Spiralbohrer

Kurze Ausführung, mit Innenkühlung, Diamant beschichtet

Solid carbide drills

Short design, with through tool coolant, diamond coated

Ausführung 3 x D für Aluminium / Execution 3 x D for aluminium

Bezeichnung Designation	D m7	d _A h6	l	l ₂	l ₄
SPC0720-0216-ALU VHM/DLC	7,20	8,00	79,0	41	21,60
SPC0730-0219-ALU VHM/DLC	7,30	8,00	79,0	41	21,90
SPC0740-0222-ALU VHM/DLC	7,40	8,00	79,0	41	22,20
SPC0750-0225-ALU VHM/DLC	7,50	8,00	79,0	41	22,50
SPC0760-0228-ALU VHM/DLC	7,60	8,00	79,0	41	22,80
SPC0770-0231-ALU VHM/DLC	7,70	8,00	79,0	41	23,10
SPC0780-0234-ALU VHM/DLC	7,80	8,00	79,0	41	23,40
SPC0790-0237-ALU VHM/DLC	7,90	8,00	79,0	41	23,70
SPC0800-0240-ALU VHM/DLC	8,00	10,00	79,0	41	24,00
SPC0810-0243-ALU VHM/DLC	8,10	10,00	89,0	47	24,30
SPC0820-0246-ALU VHM/DLC	8,20	10,00	89,0	47	24,60
SPC0830-0249-ALU VHM/DLC	8,30	10,00	89,0	47	24,90
SPC0840-0252-ALU VHM/DLC	8,40	10,00	89,0	47	25,20
SPC0850-0255-ALU VHM/DLC	8,50	10,00	89,0	47	25,50
SPC0860-0258-ALU VHM/DLC	8,60	10,00	89,0	47	25,80
SPC0870-0261-ALU VHM/DLC	8,70	10,00	89,0	47	26,10
SPC0880-0264-ALU VHM/DLC	8,80	10,00	89,0	47	26,40
SPC0890-0267-ALU VHM/DLC	8,90	10,00	89,0	47	26,70
SPC0900-0270-ALU VHM/DLC	9,00	10,00	89,0	47	27,00
SPC0910-0273-ALU VHM/DLC	9,10	10,00	89,0	47	27,30
SPC0920-0276-ALU VHM/DLC	9,20	10,00	89,0	47	27,60
SPC0930-0279-ALU VHM/DLC	9,30	10,00	89,0	47	27,90
SPC0940-0282-ALU VHM/DLC	9,40	10,00	89,0	47	28,20
SPC0950-0285-ALU VHM/DLC	9,50	10,00	89,0	47	28,50
SPC0960-0288-ALU VHM/DLC	9,60	10,00	89,0	47	28,80
SPC0970-0291-ALU VHM/DLC	9,70	10,00	89,0	47	29,10
SPC0980-0294-ALU VHM/DLC	9,80	10,00	89,0	47	29,40
SPC0990-0297-ALU VHM/DLC	9,90	10,00	89,0	55	29,70
SPC1000-0300-ALU VHM/DLC	10,00	10,00	89,0	55	30,00
SPC1010-0303-ALU VHM/DLC	10,10	12,00	102,0	55	30,30
SPC1020-0306-ALU VHM/DLC	10,20	12,00	102,0	55	30,60
SPC1030-0309-ALU VHM/DLC	10,30	12,00	102,0	55	30,90
SPC1040-0312-ALU VHM/DLC	10,40	12,00	102,0	55	31,20
SPC1050-0315-ALU VHM/DLC	10,50	12,00	102,0	55	31,50
SPC1060-0318-ALU VHM/DLC	10,60	12,00	102,0	55	31,80
SPC1070-0321-ALU VHM/DLC	10,70	12,00	102,0	55	32,10
SPC1080-0324-ALU VHM/DLC	10,80	12,00	102,0	55	32,40
SPC1090-0327-ALU VHM/DLC	10,90	12,00	102,0	55	32,70
SPC1100-0330-ALU VHM/DLC	11,00	12,00	102,0	55	33,00
SPC1110-0333-ALU VHM/DLC	11,10	12,00	102,0	55	33,30
SPC1120-0336-ALU VHM/DLC	11,20	12,00	102,0	55	33,60
SPC1130-0339-ALU VHM/DLC	11,30	12,00	102,0	55	33,90
SPC1140-0342-ALU VHM/DLC	11,40	12,00	102,0	55	34,20
SPC1150-0345-ALU VHM/DLC	11,50	12,00	102,0	55	34,50
SPC1160-0348-ALU VHM/DLC	11,60	12,00	102,0	55	34,80
SPC1170-0351-ALU VHM/DLC	11,70	12,00	102,0	55	35,10
SPC1180-0354-ALU VHM/DLC	11,80	12,00	102,0	55	35,40
SPC1190-0357-ALU VHM/DLC	11,90	12,00	102,0	55	35,70
SPC1200-0360-ALU VHM/DLC	12,00	12,00	102,0	55	36,00
SPC1250-0375-ALU VHM/DLC	12,50	14,00	107,0	60	37,50
SPC1280-0384-ALU VHM/DLC	12,80	14,00	107,0	60	38,40
SPC1300-0390-ALU VHM/DLC	13,00	14,00	107,0	60	39,00
SPC1350-0405-ALU VHM/DLC	13,50	14,00	107,0	60	40,50
SPC1380-0414-ALU VHM/DLC	13,80	14,00	107,0	60	41,40
SPC1400-0420-ALU VHM/DLC	14,00	14,00	107,0	60	42,00
SPC1420-0426-ALU VHM/DLC	14,20	16,00	115,0	65	42,60
SPC1450-0435-ALU VHM/DLC	14,50	16,00	115,0	65	43,50
SPC1500-0450-ALU VHM/DLC	15,00	16,00	115,0	65	45,00

Bezeichnung Designation	D m7	d _A h6	l	l ₂	l ₄
SPC1550-0465-ALU VHM/DLC	15,50	16,00	115,0	65	46,50
SPC1580-0474-ALU VHM/DLC	15,80	16,00	115,0	65	47,40
SPC1600-0480-ALU VHM/DLC	16,00	16,00	115,0	65	48,00
SPC1650-0495-ALU VHM/DLC	16,50	18,00	123,0	73	49,50
SPC1680-0504-ALU VHM/DLC	16,80	18,00	123,0	73	50,40
SPC1700-0510-ALU VHM/DLC	17,00	18,00	123,0	73	51,00
SPC1750-0525-ALU VHM/DLC	17,50	18,00	123,0	73	52,50
SPC1780-0534-ALU VHM/DLC	17,80	18,00	123,0	73	53,40
SPC1800-0540-ALU VHM/DLC	18,00	18,00	123,0	73	54,00
SPC1850-0555-ALU VHM/DLC	18,50	20,00	131,0	79	55,50
SPC1880-0564-ALU VHM/DLC	18,80	20,00	131,0	79	56,40
SPC1900-0570-ALU VHM/DLC	19,00	20,00	131,0	79	57,00
SPC1950-0585-ALU VHM/DLC	19,50	20,00	131,0	79	58,50
SPC1980-0594-ALU VHM/DLC	19,80	20,00	131,0	79	59,40
SPC2000-0600-ALU VHM/DLC	20,00	20,00	131,0	79	60,00

Vollhartmetall-Spiralbohrer

Kurze Ausführung, mit Innenkühlung



Solid carbide drills

Short design, with through tool coolant

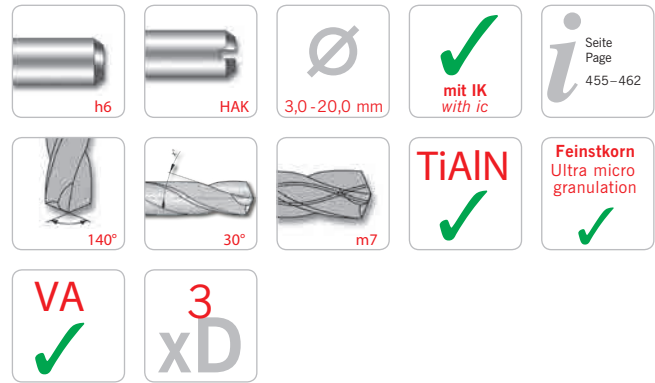

Ausführung 3 x D für rostfreie Stähle / Execution 3 x D for stainless steel

Bezeichnung Designation	D m7	d _A h6	l	l ₂	l ₄
SPC0300-0090-VA VHM/TIALN	3,00	6,00	62,0	20	9,00
SPC0310-0093-VA VHM/TIALN	3,10	6,00	62,0	20	9,30
SPC0320-0096-VA VHM/TIALN	3,20	6,00	62,0	20	9,60
SPC0330-0099-VA VHM/TIALN	3,30	6,00	62,0	20	9,90
SPC0340-0102-VA VHM/TIALN	3,40	6,00	62,0	20	10,20
SPC0350-0105-VA VHM/TIALN	3,50	6,00	62,0	20	10,50
SPC0360-0108-VA VHM/TIALN	3,60	6,00	62,0	20	10,80
SPC0370-0111-VA VHM/TIALN	3,70	6,00	62,0	20	11,10
SPC0380-0114-VA VHM/TIALN	3,80	6,00	66,0	24	11,40
SPC0390-0117-VA VHM/TIALN	3,90	6,00	66,0	24	11,70
SPC0400-0120-VA VHM/TIALN	4,00	6,00	66,0	24	12,00
SPC0410-0123-VA VHM/TIALN	4,10	6,00	66,0	24	12,30
SPC0420-0126-VA VHM/TIALN	4,20	6,00	66,0	24	12,60
SPC0430-0129-VA VHM/TIALN	4,30	6,00	66,0	24	12,90
SPC0440-0132-VA VHM/TIALN	4,40	6,00	66,0	24	13,20
SPC0450-0135-VA VHM/TIALN	4,50	6,00	66,0	24	13,50
SPC0460-0138-VA VHM/TIALN	4,60	6,00	66,0	24	13,80
SPC0470-0141-VA VHM/TIALN	4,70	6,00	66,0	24	14,10
SPC0480-0144-VA VHM/TIALN	4,80	6,00	66,0	28	14,40
SPC0490-0147-VA VHM/TIALN	4,90	6,00	66,0	28	14,70
SPC0500-0150-VA VHM/TIALN	5,00	6,00	66,0	28	15,00
SPC0510-0153-VA VHM/TIALN	5,10	6,00	66,0	28	15,30
SPC0520-0156-VA VHM/TIALN	5,20	6,00	66,0	28	15,60
SPC0530-0159-VA VHM/TIALN	5,30	6,00	66,0	28	15,90
SPC0540-0162-VA VHM/TIALN	5,40	6,00	66,0	28	16,20
SPC0550-0165-VA VHM/TIALN	5,50	6,00	66,0	28	16,50
SPC0560-0168-VA VHM/TIALN	5,60	6,00	66,0	28	16,80
SPC0570-0171-VA VHM/TIALN	5,70	6,00	66,0	28	17,10
SPC0580-0174-VA VHM/TIALN	5,80	6,00	66,0	28	17,40
SPC0590-0177-VA VHM/TIALN	5,90	6,00	66,0	28	17,70
SPC0600-0180-VA VHM/TIALN	6,00	6,00	66,0	28	18,00
SPC0610-0183-VA VHM/TIALN	6,10	8,00	79,0	34	18,30
SPC0620-0186-VA VHM/TIALN	6,20	8,00	79,0	34	18,60
SPC0630-0189-VA VHM/TIALN	6,30	8,00	79,0	34	18,90
SPC0640-0192-VA VHM/TIALN	6,40	8,00	79,0	34	19,20
SPC0650-0195-VA VHM/TIALN	6,50	8,00	79,0	34	19,50
SPC0660-0198-VA VHM/TIALN	6,60	8,00	79,0	34	19,80
SPC0670-0201-VA VHM/TIALN	6,70	8,00	79,0	34	20,10
SPC0680-0204-VA VHM/TIALN	6,80	8,00	79,0	34	20,40
SPC0690-0207-VA VHM/TIALN	6,90	8,00	79,0	34	20,70
SPC0700-0210-VA VHM/TIALN	7,00	8,00	79,0	34	21,00
SPC0710-0213-VA VHM/TIALN	7,10	8,00	79,0	41	21,30

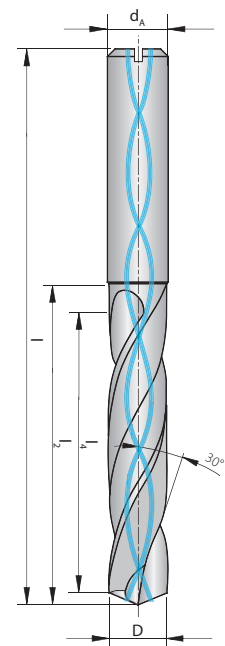

Vollhartmetall-Spiralbohrer

Kurze Ausführung, mit Innenkühlung

Solid carbide drills

Short design, with through tool coolant

Ausführung 3 x D für rostfreie Stähle / Execution 3 x D for stainless steel

Bezeichnung Designation	D m7	d _A h6	l	l ₂	l ₄
SPC0720-0216-VA VHM/TIALN	7,20	8,00	79,0	41	21,60
SPC0730-0219-VA VHM/TIALN	7,30	8,00	79,0	41	21,90
SPC0740-0222-VA VHM/TIALN	7,40	8,00	79,0	41	22,20
SPC0750-0225-VA VHM/TIALN	7,50	8,00	79,0	41	22,50
SPC0760-0228-VA VHM/TIALN	7,60	8,00	79,0	41	22,80
SPC0770-0231-VA VHM/TIALN	7,70	8,00	79,0	41	23,10
SPC0780-0234-VA VHM/TIALN	7,80	8,00	79,0	41	23,40
SPC0790-0237-VA VHM/TIALN	7,90	8,00	79,0	41	23,70
SPC0800-0240-VA VHM/TIALN	8,00	8,00	79,0	41	24,00
SPC0810-0243-VA VHM/TIALN	8,10	10,00	89,0	47	24,30
SPC0820-0246-VA VHM/TIALN	8,20	10,00	89,0	47	24,60
SPC0830-0249-VA VHM/TIALN	8,30	10,00	89,0	47	24,90
SPC0840-0252-VA VHM/TIALN	8,40	10,00	89,0	47	25,20
SPC0850-0255-VA VHM/TIALN	8,50	10,00	89,0	47	25,50
SPC0860-0258-VA VHM/TIALN	8,60	10,00	89,0	47	25,80
SPC0870-0261-VA VHM/TIALN	8,70	10,00	89,0	47	26,10
SPC0880-0264-VA VHM/TIALN	8,80	10,00	89,0	47	26,40
SPC0890-0267-VA VHM/TIALN	8,90	10,00	89,0	47	26,70
SPC0900-0270-VA VHM/TIALN	9,00	10,00	89,0	47	27,00
SPC0910-0273-VA VHM/TIALN	9,10	10,00	89,0	47	27,30
SPC0920-0276-VA VHM/TIALN	9,20	10,00	89,0	47	27,60
SPC0930-0279-VA VHM/TIALN	9,30	10,00	89,0	47	27,90
SPC0940-0282-VA VHM/TIALN	9,40	10,00	89,0	47	28,20
SPC0950-0285-VA VHM/TIALN	9,50	10,00	89,0	47	28,50
SPC0960-0288-VA VHM/TIALN	9,60	10,00	89,0	47	28,80
SPC0970-0291-VA VHM/TIALN	9,70	10,00	89,0	47	29,10
SPC0980-0294-VA VHM/TIALN	9,80	10,00	89,0	47	29,40
SPC0990-0297-VA VHM/TIALN	9,90	10,00	89,0	47	29,70
SPC1000-0300-VA VHM/TIALN	10,00	10,00	89,0	47	30,00
SPC1010-0303-VA VHM/TIALN	10,10	12,00	102,0	55	30,30
SPC1020-0306-VA VHM/TIALN	10,20	12,00	102,0	55	30,60
SPC1030-0309-VA VHM/TIALN	10,30	12,00	102,0	55	30,90
SPC1040-0312-VA VHM/TIALN	10,40	12,00	102,0	55	31,20
SPC1050-0315-VA VHM/TIALN	10,50	12,00	102,0	55	31,50
SPC1060-0318-VA VHM/TIALN	10,60	12,00	102,0	55	31,80
SPC1070-0321-VA VHM/TIALN	10,70	12,00	102,0	55	32,10
SPC1080-0324-VA VHM/TIALN	10,80	12,00	102,0	55	32,40
SPC1090-0327-VA VHM/TIALN	10,90	12,00	102,0	55	32,70
SPC1100-0330-VA VHM/TIALN	11,00	12,00	102,0	55	33,00
SPC1110-0333-VA VHM/TIALN	11,10	12,00	102,0	55	33,30
SPC1120-0336-VA VHM/TIALN	11,20	12,00	102,0	55	33,60
SPC1130-0339-VA VHM/TIALN	11,30	12,00	102,0	55	33,90
SPC1140-0342-VA VHM/TIALN	11,40	12,00	102,0	55	34,20
SPC1150-0345-VA VHM/TIALN	11,50	12,00	102,0	55	34,50
SPC1160-0348-VA VHM/TIALN	11,60	12,00	102,0	55	34,80
SPC1170-0351-VA VHM/TIALN	11,70	12,00	102,0	55	35,10
SPC1180-0354-VA VHM/TIALN	11,80	12,00	102,0	55	35,40
SPC1190-0357-VA VHM/TIALN	11,90	12,00	102,0	55	35,70
SPC1200-0360-VA VHM/TIALN	12,00	12,00	102,0	55	36,00
SPC1250-0375-VA VHM/TIALN	12,50	14,00	107,0	60	37,50
SPC1300-0390-VA VHM/TIALN	13,00	14,00	107,0	60	39,00
SPC1350-0405-VA VHM/TIALN	13,50	14,00	107,0	60	40,50
SPC1400-0420-VA VHM/TIALN	14,00	14,00	107,0	60	42,00
SPC1450-0435-VA VHM/TIALN	14,50	16,00	115,0	65	43,50
SPC1500-0450-VA VHM/TIALN	15,00	16,00	115,0	65	45,00
SPC1550-0465-VA VHM/TIALN	15,50	16,00	115,0	65	46,50
SPC1600-0480-VA VHM/TIALN	16,00	16,00	115,0	65	48,00
SPC1650-0495-VA VHM/TIALN	16,50	18,00	123,0	73	49,50

Bezeichnung Designation	D m7	d _A h6	l	l ₂	l ₄
SPC1700-0510-VA VHM/TIALN	17,00	18,00	123,0	73	51,00
SPC1750-0525-VA VHM/TIALN	17,50	18,00	123,0	73	52,50
SPC1800-0540-VA VHM/TIALN	18,00	18,00	123,0	73	54,00
SPC1850-0555-VA VHM/TIALN	18,50	20,00	131,0	79	55,50
SPC1900-0570-VA VHM/TIALN	19,00	20,00	131,0	79	57,00
SPC1950-0585-VA VHM/TIALN	19,50	20,00	131,0	79	58,50
SPC2000-0600-VA VHM/TIALN	20,00	20,00	131,0	79	60,00

PM-HSS Spiralbohrer

Kurze Ausführung, ohne Innenkühlung



Powder metal drills

Short design, without through tool coolant

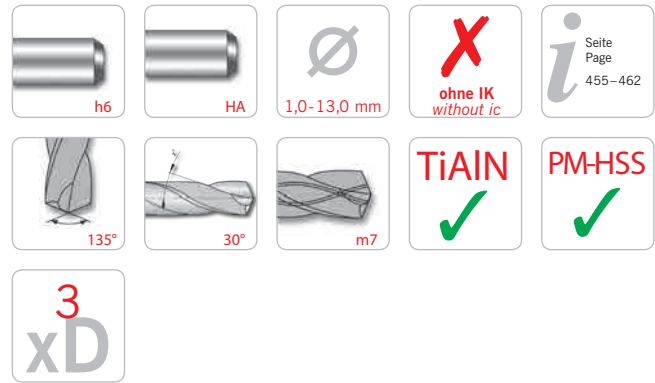

Ausführung 3 x D Pulvermetallurgisches HSS / Execution 3 x D powder metal drill

Bezeichnung Designation	D m7	d _A h6	l	l ₂	l ₄
SP0010-0030-PM TIALN	1,00	3,00	38,0	6	3,00
SP0011-0033-PM TIALN	1,10	3,00	39,0	7	3,30
SP0012-0036-PM TIALN	1,20	3,00	40,0	8	3,60
SP0013-0039-PM TIALN	1,30	3,00	40,0	8	3,90
SP0014-0042-PM TIALN	1,40	3,00	41,0	9	4,20
SP0015-0045-PM TIALN	1,50	3,00	41,0	9	4,50
SP0016-0048-PM TIALN	1,60	3,00	42,0	10	4,80
SP0017-0051-PM TIALN	1,70	3,00	42,0	10	5,10
SP0018-0054-PM TIALN	1,80	3,00	43,0	11	5,40
SP0019-0057-PM TIALN	1,90	3,00	43,0	11	5,70
SP0020-0060-PM TIALN	2,00	3,00	44,0	12	6,00
SP0021-0063-PM TIALN	2,10	3,00	44,0	12	6,30
SP0022-0066-PM TIALN	2,20	3,00	45,0	13	6,60
SP0023-0069-PM TIALN	2,30	3,00	45,0	13	6,90
SP0024-0072-PM TIALN	2,40	3,00	46,0	14	7,20
SP0025-0075-PM TIALN	2,50	3,00	46,0	14	7,50
SP0026-0078-PM TIALN	2,60	3,00	46,0	14	7,80
SP0027-0081-PM TIALN	2,70	3,00	48,0	16	8,10
SP0028-0084-PM TIALN	2,80	3,00	48,0	16	8,40
SP0029-0087-PM TIALN	2,90	3,00	48,0	16	8,70
SP0030-0090-PM TIALN	3,00	3,00	48,0	16	9,00
SP0031-0093-PM TIALN	3,10	4,00	50,0	18	9,30
SP0032-0096-PM TIALN	3,20	4,00	50,0	18	9,60
SP0033-0099-PM TIALN	3,30	4,00	50,0	18	9,90
SP0034-0102-PM TIALN	3,40	4,00	52,0	20	10,20
SP0035-0105-PM TIALN	3,50	4,00	52,0	20	10,50
SP0036-0108-PM TIALN	3,60	4,00	52,0	20	10,80
SP0037-0111-PM TIALN	3,70	4,00	52,0	20	11,10
SP0038-0114-PM TIALN	3,80	4,00	54,0	22	11,40
SP0039-0117-PM TIALN	3,90	4,00	54,0	22	11,70
SP0040-0120-PM TIALN	4,00	4,00	54,0	22	12,00
SP0041-0123-PM TIALN	4,10	6,00	66,0	22	12,30
SP0042-0126-PM TIALN	4,20	6,00	66,0	22	12,60
SP0043-0129-PM TIALN	4,30	6,00	68,0	24	12,90
SP0044-0132-PM TIALN	4,40	6,00	68,0	24	13,20
SP0045-0135-PM TIALN	4,50	6,00	68,0	24	13,50
SP0046-0138-PM TIALN	4,60	6,00	68,0	24	13,80
SP0047-0141-PM TIALN	4,70	6,00	68,0	24	14,10
SP0048-0144-PM TIALN	4,80	6,00	70,0	26	14,40
SP0049-0147-PM TIALN	4,90	6,00	70,0	26	14,70
SP0050-0150-PM TIALN	5,00	6,00	70,0	26	15,00
SP0051-0153-PM TIALN	5,10	6,00	70,0	26	15,30

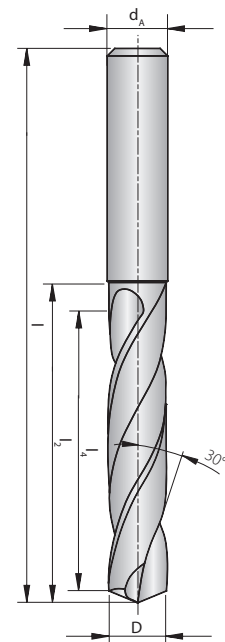

PM-HSS Spiralbohrer

Kurze Ausführung, ohne Innenkühlung

Powder metal drills

Short design, without through tool coolant

Ausführung 3 x D Pulvermetallurgisches HSS / Execution 3 x D powder metal drill

Bezeichnung Designation	D m7	d _A h6	l	l ₂	l ₄
SP0052-0156-PM TIALN	5,20	6,00	70,0	26	15,60
SP0053-0159-PM TIALN	5,30	6,00	70,0	26	15,90
SP0054-0162-PM TIALN	5,40	6,00	72,0	28	16,20
SP0055-0165-PM TIALN	5,50	6,00	72,0	28	16,50
SP00555-01665-PM TIALN 	5,55	6,00	72,0	28	16,65
SP0056-0168-PM TIALN	5,60	6,00	72,0	28	16,80
SP0057-0171-PM TIALN	5,70	6,00	72,0	28	17,10
SP0058-0174-PM TIALN	5,80	6,00	72,0	28	17,40
SP0059-0177-PM TIALN	5,90	6,00	72,0	28	17,70
SP0060-0180-PM TIALN	6,00	6,00	72,0	28	18,00
SP0061-0183-PM TIALN	6,10	8,00	75,0	31	18,30
SP0062-0186-PM TIALN	6,20	8,00	75,0	31	18,60
SP0063-0189-PM TIALN	6,30	8,00	75,0	31	18,90
SP0064-0192-PM TIALN	6,40	8,00	75,0	31	19,20
SP0065-0195-PM TIALN	6,50	8,00	75,0	31	19,50
SP0066-0198-PM TIALN	6,60	8,00	75,0	31	19,80
SP0067-0201-PM TIALN	6,70	8,00	75,0	31	20,10
SP0068-0204-PM TIALN	6,80	8,00	78,0	34	20,40
SP0069-0207-PM TIALN	6,90	8,00	78,0	34	20,70
SP0070-0210-PM TIALN	7,00	8,00	78,0	34	21,00
SP0071-0213-PM TIALN	7,10	8,00	78,0	34	21,30
SP0072-0216-PM TIALN	7,20	8,00	78,0	34	21,60
SP0073-0219-PM TIALN	7,30	8,00	78,0	34	21,90
SP0074-0222-PM TIALN	7,40	8,00	78,0	34	22,20
SP0075-0225-PM TIALN	7,50	8,00	78,0	34	22,50
SP0076-0228-PM TIALN	7,60	8,00	81,0	37	22,80
SP0077-0231-PM TIALN	7,70	8,00	81,0	37	23,10
SP0078-0234-PM TIALN	7,80	8,00	81,0	37	23,40
SP0079-0237-PM TIALN	7,90	8,00	81,0	37	23,70
SP0080-0240-PM TIALN	8,00	8,00	81,0	37	24,00
SP0081-0243-PM TIALN	8,10	10,00	87,0	37	24,30
SP0082-0246-PM TIALN	8,20	10,00	87,0	37	24,60
SP0083-0249-PM TIALN	8,30	10,00	87,0	37	24,90
SP0084-0252-PM TIALN	8,40	10,00	87,0	37	25,20
SP0085-0255-PM TIALN	8,50	10,00	87,0	37	25,50
SP0086-0258-PM TIALN	8,60	10,00	90,0	40	25,80
SP0087-0261-PM TIALN	8,70	10,00	90,0	40	26,10
SP0088-0264-PM TIALN	8,80	10,00	90,0	40	26,40
SP0089-0267-PM TIALN	8,90	10,00	90,0	40	26,70
SP0090-0270-PM TIALN	9,00	10,00	90,0	40	27,00
SP0091-0273-PM TIALN	9,10	10,00	90,0	40	27,30
SP0092-0276-PM TIALN	9,20	10,00	90,0	40	27,60
SP0093-0279-PM TIALN	9,30	10,00	90,0	40	27,90
SP0094-0282-PM TIALN	9,40	10,00	90,0	40	28,20
SP0095-0285-PM TIALN	9,50	10,00	90,0	40	28,50
SP0096-0288-PM TIALN	9,60	10,00	93,0	43	28,80
SP0097-0291-PM TIALN	9,70	10,00	93,0	43	29,10
SP0098-0294-PM TIALN	9,80	10,00	93,0	43	29,40
SP0099-0297-PM TIALN	9,90	10,00	93,0	43	29,70
SP0100-0300-PM TIALN	10,00	10,00	93,0	43	30,00
SP0101-0303-PM TIALN	10,10	12,00	100,0	43	30,30
SP0102-0306-PM TIALN	10,20	12,00	100,0	43	30,60
SP0103-0309-PM TIALN	10,30	12,00	100,0	43	30,90
SP0104-0312-PM TIALN	10,40	12,00	100,0	43	31,20
SP0105-0315-PM TIALN	10,50	12,00	100,0	43	31,50
SP0106-0318-PM TIALN	10,60	12,00	100,0	43	31,80
SP0107-0321-PM TIALN	10,70	12,00	104,0	47	32,10
SP0108-0324-PM TIALN	10,80	12,00	104,0	47	32,40

Bezeichnung Designation	D m7	d _A h6	l	l ₂	l ₄
SP0109-0327-PM TIALN	10,90	12,00	104,0	47	32,70
SP0110-0330-PM TIALN	11,00	12,00	104,0	47	33,00
SP0111-0333-PM TIALN	11,10	12,00	104,0	47	33,30
SP0112-0336-PM TIALN	11,20	12,00	104,0	47	33,60
SP0113-0339-PM TIALN	11,30	12,00	104,0	47	33,90
SP0114-0342-PM TIALN	11,40	12,00	104,0	47	34,20
SP0115-0345-PM TIALN	11,50	12,00	104,0	47	34,50
SP0116-0348-PM TIALN	11,60	12,00	104,0	47	34,80
SP0117-0351-PM TIALN	11,70	12,00	104,0	47	35,10
SP0118-0354-PM TIALN	11,80	12,00	104,0	47	35,40
SP0119-0357-PM TIALN	11,90	12,00	108,0	51	35,70
SP0120-0360-PM TIALN	12,00	12,00	108,0	51	36,00
SP0121-0363-PM TIALN	12,10	12,00	108,0	51	36,30
SP0122-0366-PM TIALN	12,20	12,00	108,0	51	36,60
SP0123-0369-PM TIALN	12,30	12,00	108,0	51	36,90
SP0124-0372-PM TIALN	12,40	12,00	108,0	51	37,20
SP0125-0375-PM TIALN	12,50	12,00	108,0	51	37,50
SP0126-0378-PM TIALN	12,60	12,00	108,0	51	37,80
SP0127-0381-PM TIALN	12,70	12,00	108,0	51	38,10
SP0128-0384-PM TIALN	12,80	12,00	108,0	51	38,40
SP0129-0387-PM TIALN	12,90	12,00	108,0	51	38,70
SP0130-0390-PM TIALN	13,00	12,00	108,0	51	39,00
SP0133-0399-PM TIALN 	13,30	12,00	108,0	51	39,90

Vollhartmetall-Spiralbohrer

Mittellange Ausführung, ohne Innenkühlung



Solid carbide drills

Mid-length design, without through tool coolant

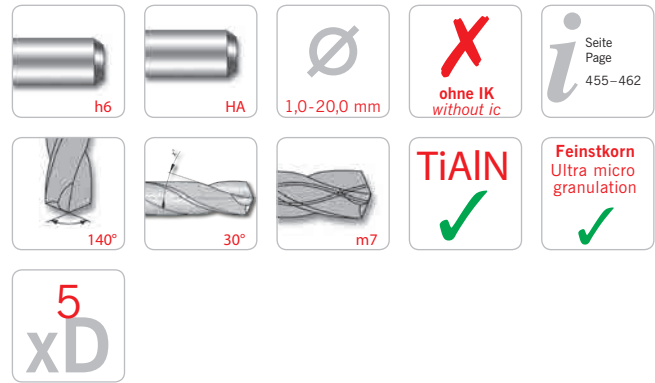

Ausführung 5 x D / Execution 5 x D

Bezeichnung Designation	D m7	d _A h6	l	l ₂	l ₄
SP0010-0050 VHM/TIALN	1,00	3,00	55,0	8	5,00
SP0011-0055 VHM/TIALN	1,10	3,00	55,0	12	5,50
SP0012-0060 VHM/TIALN	1,20	3,00	55,0	12	6,00
SP0013-0065 VHM/TIALN	1,30	3,00	55,0	12	6,50
SP0014-0070 VHM/TIALN	1,40	3,00	55,0	12	7,00
SP0015-0075 VHM/TIALN	1,50	3,00	55,0	16	7,50
SP0016-0080 VHM/TIALN	1,60	3,00	55,0	16	8,00
SP0017-0085 VHM/TIALN	1,70	3,00	55,0	16	8,50
SP0018-0090 VHM/TIALN	1,80	3,00	55,0	16	9,00
SP0019-0095 VHM/TIALN	1,90	3,00	55,0	16	9,50
SP0020-0100 VHM/TIALN	2,00	4,00	57,0	21	10,00
SP0021-0105 VHM/TIALN	2,10	4,00	57,0	21	10,50
SP0022-0110 VHM/TIALN	2,20	4,00	57,0	21	11,00
SP0023-0115 VHM/TIALN	2,30	4,00	57,0	21	11,50
SP0024-0120 VHM/TIALN	2,40	4,00	57,0	21	12,00
SP0025-0125 VHM/TIALN	2,50	4,00	57,0	21	12,50
SP0026-0130 VHM/TIALN	2,60	4,00	57,0	21	13,00
SP0027-0135 VHM/TIALN	2,70	4,00	57,0	21	13,50
SP0028-0140 VHM/TIALN	2,80	4,00	57,0	21	14,00
SP0029-0145 VHM/TIALN	2,90	4,00	57,0	21	14,50
SP0030-0150 VHM/TIALN	3,00	6,00	66,0	28	15,00
SP0031-0155 VHM/TIALN	3,10	6,00	66,0	28	15,50
SP0032-0160 VHM/TIALN	3,20	6,00	66,0	28	16,00
SP0033-0165 VHM/TIALN	3,30	6,00	66,0	28	16,50
SP0034-0170 VHM/TIALN	3,40	6,00	66,0	28	17,00
SP0035-0175 VHM/TIALN	3,50	6,00	66,0	28	17,50
SP0036-0180 VHM/TIALN	3,60	6,00	66,0	28	18,00
SP0037-0185 VHM/TIALN	3,70	6,00	66,0	28	18,50
SP0038-0190 VHM/TIALN	3,80	6,00	74,0	36	19,00
SP0039-0195 VHM/TIALN	3,90	6,00	74,0	36	19,50
SP0040-0200 VHM/TIALN	4,00	6,00	74,0	36	20,00
SP0041-0205 VHM/TIALN	4,10	6,00	74,0	36	20,50
SP0042-0210 VHM/TIALN	4,20	6,00	74,0	36	21,00
SP0043-0215 VHM/TIALN	4,30	6,00	74,0	36	21,50
SP0044-0220 VHM/TIALN	4,40	6,00	74,0	36	22,00
SP0045-0225 VHM/TIALN	4,50	6,00	74,0	36	22,50
SP0046-0230 VHM/TIALN	4,60	6,00	74,0	36	23,00
SP0047-0235 VHM/TIALN	4,70	6,00	74,0	36	23,50
SP0048-0240 VHM/TIALN	4,80	6,00	82,0	44	24,00
SP0049-0245 VHM/TIALN	4,90	6,00	82,0	44	24,50
SP0050-0250 VHM/TIALN	5,00	6,00	82,0	44	25,00
SP0051-0255 VHM/TIALN	5,10	6,00	82,0	44	25,50

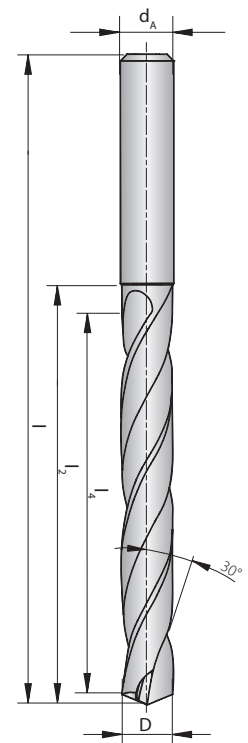

Vollhartmetall-Spiralbohrer

Mittellange Ausführung, ohne Innenkühlung

Ausführung 5 x D / Execution 5 x D

Bezeichnung Designation	D m7	d _A h6	l	l ₂	l ₄
SP0052-0260 VHM/TIALN	5,20	6,00	82,0	44	26,00
SP0053-0265 VHM/TIALN	5,30	6,00	82,0	44	26,50
SP0054-0270 VHM/TIALN	5,40	6,00	82,0	44	27,00
SP0055-0275 VHM/TIALN	5,50	6,00	82,0	44	27,50
SP0056-0280 VHM/TIALN	5,60	6,00	82,0	44	28,00
SP0057-0285 VHM/TIALN	5,70	6,00	82,0	44	28,50
SP0058-0290 VHM/TIALN	5,80	6,00	82,0	44	29,00
SP0059-0295 VHM/TIALN	5,90	6,00	82,0	44	29,50
SP0060-0300 VHM/TIALN	6,00	6,00	82,0	44	30,00
SP0061-0305 VHM/TIALN	6,10	8,00	91,0	53	30,50
SP0062-0310 VHM/TIALN	6,20	8,00	91,0	53	31,00
SP0063-0315 VHM/TIALN	6,30	8,00	91,0	53	31,50
SP0064-0320 VHM/TIALN	6,40	8,00	91,0	53	32,00
SP0065-0325 VHM/TIALN	6,50	8,00	91,0	53	32,50
SP0066-0330 VHM/TIALN	6,60	8,00	91,0	53	33,00
SP0067-0335 VHM/TIALN	6,70	8,00	91,0	53	33,50
SP0068-0340 VHM/TIALN	6,80	8,00	91,0	53	34,00
SP0069-0345 VHM/TIALN	6,90	8,00	91,0	53	34,50
SP0070-0350 VHM/TIALN	7,00	8,00	91,0	53	35,00
SP0071-0355 VHM/TIALN	7,10	8,00	91,0	53	35,50
SP0072-0360 VHM/TIALN	7,20	8,00	91,0	53	36,00
SP0073-0365 VHM/TIALN	7,30	8,00	91,0	53	36,50
SP0074-0370 VHM/TIALN	7,40	8,00	91,0	53	37,00
SP0075-0375 VHM/TIALN	7,50	8,00	91,0	53	37,50
SP0076-0380 VHM/TIALN	7,60	8,00	91,0	53	38,00
SP0077-0385 VHM/TIALN	7,70	8,00	91,0	53	38,50
SP0078-0390 VHM/TIALN	7,80	8,00	91,0	53	39,00
SP0079-0395 VHM/TIALN	7,90	8,00	91,0	53	39,50
SP0080-0400 VHM/TIALN	8,00	8,00	91,0	53	40,00
SP0081-0405 VHM/TIALN	8,10	10,00	103,0	61	40,50
SP0082-0410 VHM/TIALN	8,20	10,00	103,0	61	41,00
SP0083-0415 VHM/TIALN	8,30	10,00	103,0	61	41,50
SP0084-0420 VHM/TIALN	8,40	10,00	103,0	61	42,00
SP0085-0425 VHM/TIALN	8,50	10,00	103,0	61	42,50
SP0086-0430 VHM/TIALN	8,60	10,00	103,0	61	43,00
SP0087-0435 VHM/TIALN	8,70	10,00	103,0	61	43,50
SP0088-0440 VHM/TIALN	8,80	10,00	103,0	61	44,00
SP0089-0445 VHM/TIALN	8,90	10,00	103,0	61	44,50
SP0090-0450 VHM/TIALN	9,00	10,00	103,0	61	45,00
SP0091-0455 VHM/TIALN	9,10	10,00	103,0	61	45,50
SP0092-0460 VHM/TIALN	9,20	10,00	103,0	61	46,00
SP0093-0465 VHM/TIALN	9,30	10,00	103,0	61	46,50
SP0094-0470 VHM/TIALN	9,40	10,00	103,0	61	47,00
SP0095-0475 VHM/TIALN	9,50	10,00	103,0	61	47,50
SP0096-0480 VHM/TIALN	9,60	10,00	103,0	61	48,00
SP0097-0485 VHM/TIALN	9,70	10,00	103,0	61	48,50
SP0098-0490 VHM/TIALN	9,80	10,00	103,0	61	49,00
SP0099-0495 VHM/TIALN	9,90	10,00	103,0	61	49,50
SP0100-0500 VHM/TIALN	10,00	10,00	103,0	61	50,00
SP0101-0505 VHM/TIALN	10,10	12,00	118,0	71	50,50
SP0102-0510 VHM/TIALN	10,20	12,00	118,0	71	51,00
SP0103-0515 VHM/TIALN	10,30	12,00	118,0	71	51,50
SP0104-0520 VHM/TIALN	10,40	12,00	118,0	71	52,00
SP0105-0525 VHM/TIALN	10,50	12,00	118,0	71	52,50
SP0106-0530 VHM/TIALN	10,60	12,00	118,0	71	53,00
SP0107-0535 VHM/TIALN	10,70	12,00	118,0	71	53,50
SP0108-0540 VHM/TIALN	10,80	12,00	118,0	71	54,00
SP0109-0545 VHM/TIALN	10,90	12,00	118,0	71	54,50

Solid carbide drills

Mid-length design, without through tool coolant

Bezeichnung Designation	D m7	d _A h6	l	l ₂	l ₄
SP0110-0550 VHM/TIALN	11,00	12,00	118,0	71	55,00
SP0111-0555 VHM/TIALN	11,10	12,00	118,0	71	55,50
SP0112-0560 VHM/TIALN	11,20	12,00	118,0	71	56,00
SP0113-0565 VHM/TIALN	11,30	12,00	118,0	71	56,50
SP0114-0570 VHM/TIALN	11,40	12,00	118,0	71	57,00
SP0115-0575 VHM/TIALN	11,50	12,00	118,0	71	57,50
SP0116-0580 VHM/TIALN	11,60	12,00	118,0	71	58,00
SP0117-0585 VHM/TIALN	11,70	12,00	118,0	71	58,50
SP0118-0590 VHM/TIALN	11,80	12,00	118,0	71	59,00
SP0119-0595 VHM/TIALN	11,90	12,00	118,0	71	59,50
SP0120-0600 VHM/TIALN	12,00	12,00	118,0	71	60,00
SP0123-0615 VHM/TIALN	12,30	14,00	124,0	77	61,50
SP0125-0625 VHM/TIALN	12,50	14,00	124,0	77	62,50
SP0128-0640 VHM/TIALN	12,80	14,00	124,0	77	64,00
SP0130-0650 VHM/TIALN	13,00	14,00	124,0	77	65,00
SP0135-0675 VHM/TIALN	13,50	14,00	124,0	77	67,50
SP0138-0690 VHM/TIALN	13,80	14,00	124,0	77	69,00
SP0140-0700 VHM/TIALN	14,00	14,00	124,0	77	70,00
SP0145-0725 VHM/TIALN	14,50	16,00	133,0	83	72,50
SP0148-0740 VHM/TIALN	14,80	16,00	133,0	83	74,00
SP0150-0750 VHM/TIALN	15,00	16,00	133,0	83	75,00
SP0155-0775 VHM/TIALN	15,50	16,00	133,0	83	77,50
SP0158-0790 VHM/TIALN	15,80	16,00	133,0	83	79,00
SP0160-0800 VHM/TIALN	16,00	16,00	133,0	83	80,00
SP0165-0825 VHM/TIALN	16,50	18,00	143,0	93	82,50
SP0168-0840 VHM/TIALN	16,80	18,00	143,0	93	84,00
SP0170-0850 VHM/TIALN	17,00	18,00	143,0	93	85,00
SP0175-0875 VHM/TIALN	17,50	18,00	143,0	93	87,50
SP0178-0890 VHM/TIALN	17,80	18,00	143,0	93	89,00
SP0180-0900 VHM/TIALN	18,00	18,00	143,0	93	90,00
SP0185-0925 VHM/TIALN	18,50	20,00	153,0	101	92,50
SP0190-0950 VHM/TIALN	19,00	20,00	153,0	101	95,00
SP0195-0975 VHM/TIALN	19,50	20,00	153,0	101	97,50
SP0198-0990 VHM/TIALN	19,80	20,00	153,0	101	99,00
SP0200-1000 VHM/TIALN	20,00	20,00	153,0	101	100,00

Vollhartmetall-Spiralbohrer

Mittellange Ausführung, mit Innenkühlung



N NEU/NEW

Solid carbide drills

Mid-length design, with through tool coolant

1,0-20,0 mm

mit IK
with ic

Seite
Page
455-462

TiAlN

Feinstkorn
Ultra micro
granulation

5
xD

Ausführung 5 x D / Execution 5 x D

Bezeichnung Designation	D m7	d _A h6	l	l ₂	l ₄
SPC0010-0050 VHM/TIALN	1,00	3,00	55,0	8	5,00
SPC0011-0055 VHM/TIALN	1,10	3,00	55,0	12	5,50
SPC0012-0060 VHM/TIALN	1,20	3,00	55,0	12	6,00
SPC0013-0065 VHM/TIALN	1,30	3,00	55,0	12	6,50
SPC0014-0070 VHM/TIALN	1,40	3,00	55,0	12	7,00
SPC0015-0075 VHM/TIALN	1,50	3,00	55,0	16	7,50
SPC0016-0080 VHM/TIALN	1,60	3,00	55,0	16	8,00
SPC0017-0085 VHM/TIALN	1,70	3,00	55,0	16	8,50
SPC0018-0090 VHM/TIALN	1,80	3,00	55,0	16	9,00
SPC0019-0095 VHM/TIALN	1,90	3,00	55,0	16	9,50
SPC0020-0100 VHM/TIALN	2,00	4,00	57,0	21	10,00
SPC0021-0105 VHM/TIALN	2,10	4,00	57,0	21	10,50
SPC0022-0110 VHM/TIALN	2,20	4,00	57,0	21	11,00
SPC0023-0115 VHM/TIALN	2,30	4,00	57,0	21	11,50
SPC0024-0120 VHM/TIALN	2,40	4,00	57,0	21	12,00
SPC0025-0125 VHM/TIALN	2,50	4,00	57,0	21	12,50
SPC0026-0130 VHM/TIALN	2,60	4,00	57,0	21	13,00
SPC0027-0135 VHM/TIALN	2,70	4,00	57,0	21	13,50
SPC0028-0140 VHM/TIALN	2,80	4,00	57,0	21	14,00
SPC0029-0145 VHM/TIALN	2,90	4,00	57,0	21	14,50
SPC0030-0150 VHM/TIALN	3,00	6,00	66,0	28	15,00
SPC0031-0155 VHM/TIALN	3,10	6,00	66,0	28	15,50
SPC0032-0160 VHM/TIALN	3,20	6,00	66,0	28	16,00
SPC0033-0165 VHM/TIALN	3,30	6,00	66,0	28	16,50
SPC0034-0170 VHM/TIALN	3,40	6,00	66,0	28	17,00
SPC0035-0175 VHM/TIALN	3,50	6,00	66,0	28	17,50
SPC0036-0180 VHM/TIALN	3,60	6,00	66,0	28	18,00
SPC0037-0185 VHM/TIALN	3,70	6,00	66,0	28	18,50
SPC0038-0190 VHM/TIALN	3,80	6,00	74,0	36	19,00
SPC0039-0195 VHM/TIALN	3,90	6,00	74,0	36	19,50
SPC0040-0200 VHM/TIALN	4,00	6,00	74,0	36	20,00
SPC0041-0205 VHM/TIALN	4,10	6,00	74,0	36	20,50
SPC0042-0210 VHM/TIALN	4,20	6,00	74,0	36	21,00
SPC0043-0215 VHM/TIALN	4,30	6,00	74,0	36	21,50
SPC0044-0220 VHM/TIALN	4,40	6,00	74,0	36	22,00
SPC0045-0225 VHM/TIALN	4,50	6,00	74,0	36	22,50
SPC0046-0230 VHM/TIALN	4,60	6,00	74,0	36	23,00
SPC00465-0233 VHM/TIALN	4,65	6,00	74,0	36	23,30
SPC0047-0235 VHM/TIALN	4,70	6,00	74,0	36	23,50
SPC0048-0240 VHM/TIALN	4,80	6,00	82,0	44	24,00
SPC0049-0245 VHM/TIALN	4,90	6,00	82,0	44	24,50
SPC0050-0250 VHM/TIALN	5,00	6,00	82,0	44	25,00

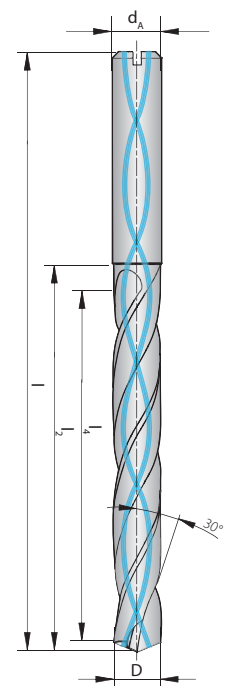

SP

Vollhartmetall-Spiralbohrer

Mittellange Ausführung, mit Innenkühlung

Ausführung 5 x D / Execution 5 x D

Bezeichnung Designation	D m7	d _A h6	l	l ₂	l ₄
SPC0051-0255 VHM/TIALN	5,10	6,00	82,0	44	25,50
SPC0052-0260 VHM/TIALN	5,20	6,00	82,0	44	26,00
SPC0053-0265 VHM/TIALN	5,30	6,00	82,0	44	26,50
SPC0054-0270 VHM/TIALN	5,40	6,00	82,0	44	27,00
SPC00555-0278 VHM/TIALN	5,50	6,00	82,0	44	27,50
SPC0055-0278 VHM/TIALN	5,55	6,00	82,0	44	27,80
SPC0056-0280 VHM/TIALN	5,60	6,00	82,0	44	28,00
SPC0057-0285 VHM/TIALN	5,70	6,00	82,0	44	28,50
SPC0058-0290 VHM/TIALN	5,80	6,00	82,0	44	29,00
SPC0059-0295 VHM/TIALN	5,90	6,00	82,0	44	29,50
SPC0060-0300 VHM/TIALN	6,00	6,00	82,0	44	30,00
SPC0061-0305 VHM/TIALN	6,10	8,00	91,0	53	30,50
SPC0062-0310 VHM/TIALN	6,20	8,00	91,0	53	31,00
SPC0063-0315 VHM/TIALN	6,30	8,00	91,0	53	31,50
SPC0064-0320 VHM/TIALN	6,40	8,00	91,0	53	32,00
SPC0065-0325 VHM/TIALN	6,50	8,00	91,0	53	32,50
SPC0066-0330 VHM/TIALN	6,60	8,00	91,0	53	33,00
SPC0067-0335 VHM/TIALN	6,70	8,00	91,0	53	33,50
SPC0068-0340 VHM/TIALN	6,80	8,00	91,0	53	34,00
SPC0069-0345 VHM/TIALN	6,90	8,00	91,0	53	34,50
SPC0070-0350 VHM/TIALN	7,00	8,00	91,0	53	35,00
SPC0071-0355 VHM/TIALN	7,10	8,00	91,0	53	35,50
SPC0072-0360 VHM/TIALN	7,20	8,00	91,0	53	36,00
SPC0073-0365 VHM/TIALN	7,30	8,00	91,0	53	36,50
SPC0074-0370 VHM/TIALN	7,40	8,00	91,0	53	37,00
SPC0075-0375 VHM/TIALN	7,50	8,00	91,0	53	37,50
SPC0076-0380 VHM/TIALN	7,60	8,00	91,0	53	38,00
SPC0077-0385 VHM/TIALN	7,70	8,00	91,0	53	38,50
SPC0078-0390 VHM/TIALN	7,80	8,00	91,0	53	39,00
SPC0079-0395 VHM/TIALN	7,90	8,00	91,0	53	39,50
SPC0080-0400 VHM/TIALN	8,00	8,00	91,0	53	40,00
SPC0081-0405 VHM/TIALN	8,10	10,00	103,0	61	40,50
SPC0082-0410 VHM/TIALN	8,20	10,00	103,0	61	41,00
SPC0083-0415 VHM/TIALN	8,30	10,00	103,0	61	41,50
SPC0084-0420 VHM/TIALN	8,40	10,00	103,0	61	42,00
SPC0085-0425 VHM/TIALN	8,50	10,00	103,0	61	42,50
SPC0086-0430 VHM/TIALN	8,60	10,00	103,0	61	43,00
SPC0087-0435 VHM/TIALN	8,70	10,00	103,0	61	43,50
SPC0088-0440 VHM/TIALN	8,80	10,00	103,0	61	44,00
SPC0089-0445 VHM/TIALN	8,90	10,00	103,0	61	44,50
SPC0090-0450 VHM/TIALN	9,00	10,00	103,0	61	45,00
SPC0091-0455 VHM/TIALN	9,10	10,00	103,0	61	45,50
SPC0092-0460 VHM/TIALN	9,20	10,00	103,0	61	46,00
SPC0093-0465 VHM/TIALN	9,30	10,00	103,0	61	46,50
SPC0094-0470 VHM/TIALN	9,40	10,00	103,0	61	47,00
SPC0095-0475 VHM/TIALN	9,50	10,00	103,0	61	47,50
SPC0096-0480 VHM/TIALN	9,60	10,00	103,0	61	48,00
SPC0097-0485 VHM/TIALN	9,70	10,00	103,0	61	48,50
SPC0098-0490 VHM/TIALN	9,80	10,00	103,0	61	49,00
SPC0099-0495 VHM/TIALN	9,90	10,00	103,0	61	49,50
SPC0100-0500 VHM/TIALN	10,00	10,00	103,0	61	50,00
SPC0101-0505 VHM/TIALN	10,10	12,00	118,0	71	50,50
SPC0102-0510 VHM/TIALN	10,20	12,00	118,0	71	51,00
SPC0103-0515 VHM/TIALN	10,30	12,00	118,0	71	51,50
SPC0104-0520 VHM/TIALN	10,40	12,00	118,0	71	52,00
SPC0105-0525 VHM/TIALN	10,50	12,00	118,0	71	52,50
SPC0106-0530 VHM/TIALN	10,60	12,00	118,0	71	53,00
SPC0107-0535 VHM/TIALN	10,70	12,00	118,0	71	53,50

Solid carbide drills

Mid-length design, with through tool coolant

Bezeichnung Designation	D m7	d _A h6	l	l ₂	l ₄
SPC0108-0540 VHM/TIALN	10,80	12,00	118,0	71	54,00
SPC0109-0545 VHM/TIALN	10,90	12,00	118,0	71	54,50
SPC0110-0550 VHM/TIALN	11,00	12,00	118,0	71	55,00
SPC0111-0555 VHM/TIALN	11,10	12,00	118,0	71	55,50
SPC0112-0560 VHM/TIALN	11,20	12,00	118,0	71	56,00
SPC0113-0565 VHM/TIALN	11,30	12,00	118,0	71	56,50
SPC0114-0570 VHM/TIALN	11,40	12,00	118,0	71	57,00
SPC0115-0575 VHM/TIALN	11,50	12,00	118,0	71	57,50
SPC0116-0580 VHM/TIALN	11,60	12,00	118,0	71	58,00
SPC0117-0585 VHM/TIALN	11,70	12,00	118,0	71	58,50
SPC0118-0590 VHM/TIALN	11,80	12,00	118,0	71	59,00
SPC0119-0595 VHM/TIALN	11,90	12,00	118,0	71	59,50
SPC0120-0600 VHM/TIALN	12,00	12,00	118,0	71	60,00
SPC0125-0625 VHM/TIALN	12,50	14,00	124,0	77	62,50
SPC0127-0635 VHM/TIALN	12,70	14,00	124,0	77	63,50
SPC0128-0640 VHM/TIALN	12,80	14,00	124,0	77	64,00
SPC0130-0650 VHM/TIALN	13,00	14,00	124,0	77	65,00
SPC0132-0660 VHM/TIALN	13,20	14,00	124,0	77	66,00
SPC0135-0675 VHM/TIALN	13,50	14,00	124,0	77	67,50
SPC0140-0700 VHM/TIALN	14,00	14,00	124,0	77	70,00
SPC0142-0710 VHM/TIALN	14,20	16,00	133,0	83	71,00
SPC0145-0725 VHM/TIALN	14,50	16,00	133,0	83	72,50
SPC0150-0750 VHM/TIALN	15,00	16,00	133,0	83	75,00
SPC0155-0775 VHM/TIALN	15,50	16,00	133,0	83	77,50
SPC0160-0800 VHM/TIALN	16,00	16,00	133,0	83	80,00
SPC0165-0825 VHM/TIALN	16,50	18,00	143,0	93	82,50
SPC0170-0850 VHM/TIALN	17,00	18,00	143,0	93	85,00
SPC0175-0875 VHM/TIALN	17,50	18,00	143,0	93	87,50
SPC0180-0900 VHM/TIALN	18,00	18,00	143,0	93	90,00
SPC0185-0925 VHM/TIALN	18,50	20,00	153,0	101	92,50
SPC0188-0940 VHM/TIALN	18,80	20,00	153,0	101	94,00
SPC0190-0950 VHM/TIALN	19,00	20,00	153,0	101	95,00
SPC0195-0975 VHM/TIALN	19,50	20,00	153,0	101	97,50
SPC0200-1000 VHM/TIALN	20,00	20,00	153,0	101	100,00

Vollhartmetall-Spiralbohrer

Mittellange Ausführung, mit Innenkühlung, Diamant beschichtet



Solid carbide drills

Mid-length design, with through tool coolant, diamond coated

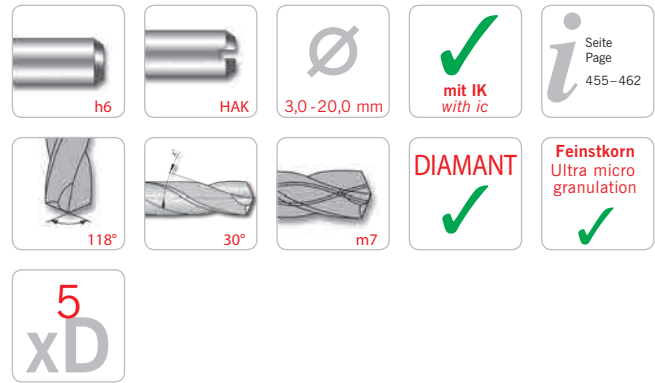

Ausführung 5 x D für Aluminium / Execution 5 x D for aluminium

Bezeichnung Designation	D m7	d _A h6	l	l ₂	l ₄
SPC0030-0150-ALU VHM/DLC	3,00	6,00	66,0	28	15,00
SPC0031-0155-ALU VHM/DLC	3,10	6,00	66,0	28	15,50
SPC0032-0160-ALU VHM/DLC	3,20	6,00	66,0	28	16,00
SPC0033-0165-ALU VHM/DLC	3,30	6,00	66,0	28	16,50
SPC0034-0170-ALU VHM/DLC	3,40	6,00	66,0	28	17,00
SPC0035-0175-ALU VHM/DLC	3,50	6,00	66,0	28	17,50
SPC0036-0180-ALU VHM/DLC	3,60	6,00	66,0	28	18,00
SPC0037-0185-ALU VHM/DLC	3,70	6,00	66,0	28	18,50
SPC0038-0190-ALU VHM/DLC	3,80	6,00	74,0	36	19,00
SPC0039-0195-ALU VHM/DLC	3,90	6,00	74,0	36	19,50
SPC0040-0200-ALU VHM/DLC	4,00	6,00	74,0	36	20,00
SPC0041-0205-ALU VHM/DLC	4,10	6,00	74,0	36	20,50
SPC0042-0210-ALU VHM/DLC	4,20	6,00	74,0	36	21,00
SPC0043-0215-ALU VHM/DLC	4,30	6,00	74,0	36	21,50
SPC0044-0220-ALU VHM/DLC	4,40	6,00	74,0	36	22,00
SPC0045-0225-ALU VHM/DLC	4,50	6,00	74,0	36	22,50
SPC0046-0230-ALU VHM/DLC	4,60	6,00	74,0	36	23,00
SPC0047-0235-ALU VHM/DLC	4,70	6,00	74,0	36	23,50
SPC0048-0240-ALU VHM/DLC	4,80	6,00	82,0	44	24,00
SPC0049-0245-ALU VHM/DLC	4,90	6,00	82,0	44	24,50
SPC0050-0250-ALU VHM/DLC	5,00	6,00	82,0	44	25,00
SPC0051-0255-ALU VHM/DLC	5,10	6,00	82,0	44	25,50
SPC0052-0260-ALU VHM/DLC	5,20	6,00	82,0	44	26,00
SPC0053-0265-ALU VHM/DLC	5,30	6,00	82,0	44	26,50
SPC0054-0270-ALU VHM/DLC	5,40	6,00	82,0	44	27,00
SPC0055-0275-ALU VHM/DLC	5,50	6,00	82,0	44	27,50
SPC0056-0280-ALU VHM/DLC	5,60	6,00	82,0	44	28,00
SPC0057-0285-ALU VHM/DLC	5,70	6,00	82,0	44	28,50
SPC0058-0290-ALU VHM/DLC	5,80	6,00	82,0	44	29,00
SPC0059-0295-ALU VHM/DLC	5,90	6,00	82,0	44	29,50
SPC0060-0300-ALU VHM/DLC	6,00	6,00	82,0	44	30,00
SPC0061-0305-ALU VHM/DLC	6,10	8,00	91,0	53	30,50
SPC0062-0310-ALU VHM/DLC	6,20	8,00	91,0	53	31,00
SPC0063-0315-ALU VHM/DLC	6,30	8,00	91,0	53	31,50
SPC0064-0320-ALU VHM/DLC	6,40	8,00	91,0	53	32,00
SPC0065-0325-ALU VHM/DLC	6,50	8,00	91,0	53	32,50
SPC0066-0330-ALU VHM/DLC	6,60	8,00	91,0	53	33,00
SPC0067-0335-ALU VHM/DLC	6,70	8,00	91,0	53	33,50
SPC0068-0340-ALU VHM/DLC	6,80	8,00	91,0	53	34,00
SPC0069-0345-ALU VHM/DLC	6,90	8,00	91,0	53	34,50
SPC0070-0350-ALU VHM/DLC	7,00	8,00	91,0	53	35,00
SPC0071-0355-ALU VHM/DLC	7,10	8,00	91,0	53	35,50

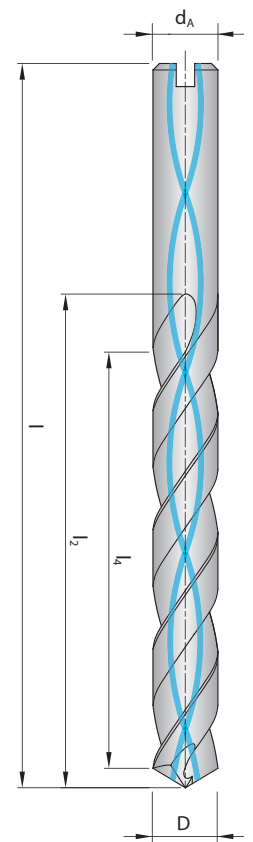

Vollhartmetall-Spiralbohrer

Mittellange Ausführung, mit Innenkühlung, Diamant beschichtet

Solid carbide drills

Mid-length design, with through tool coolant, diamond coated

Ausführung 5 x D für Aluminium / Execution 5 x D for aluminium

Bezeichnung Designation	D m7	d _A h6	l	l ₂	l ₄
SPC0072-0360-ALU VHM/DLC	7,20	8,00	91,0	53	36,00
SPC0073-0365-ALU VHM/DLC	7,30	8,00	91,0	53	36,50
SPC0074-0370-ALU VHM/DLC	7,40	8,00	91,0	53	37,00
SPC0075-0375-ALU VHM/DLC	7,50	8,00	91,0	53	37,50
SPC0076-0380-ALU VHM/DLC	7,60	8,00	91,0	53	38,00
SPC0077-0385-ALU VHM/DLC	7,70	8,00	91,0	53	38,50
SPC0078-0390-ALU VHM/DLC	7,80	8,00	91,0	53	39,00
SPC0079-0395-ALU VHM/DLC	7,90	8,00	91,0	53	39,50
SPC0080-0400-ALU VHM/DLC	8,00	8,00	91,0	53	40,00
SPC0081-0405-ALU VHM/DLC	8,10	10,00	103,0	61	40,50
SPC0082-0410-ALU VHM/DLC	8,20	10,00	103,0	61	41,00
SPC0083-0415-ALU VHM/DLC	8,30	10,00	103,0	61	41,50
SPC0084-0420-ALU VHM/DLC	8,40	10,00	103,0	61	42,00
SPC0085-0425-ALU VHM/DLC	8,50	10,00	103,0	61	42,50
SPC0086-0430-ALU VHM/DLC	8,60	10,00	103,0	61	43,00
SPC0087-0435-ALU VHM/DLC	8,70	10,00	103,0	61	43,50
SPC0088-0440-ALU VHM/DLC	8,80	10,00	103,0	61	44,00
SPC0089-0445-ALU VHM/DLC	8,90	10,00	103,0	61	44,50
SPC0090-0450-ALU VHM/DLC	9,00	10,00	103,0	61	45,00
SPC0091-0455-ALU VHM/DLC	9,10	10,00	103,0	61	45,50
SPC0092-0460-ALU VHM/DLC	9,20	10,00	103,0	61	46,00
SPC0093-0465-ALU VHM/DLC	9,30	10,00	103,0	61	46,50
SPC0094-0470-ALU VHM/DLC	9,40	10,00	103,0	61	47,00
SPC0095-0475-ALU VHM/DLC	9,50	10,00	103,0	61	47,50
SPC0096-0480-ALU VHM/DLC	9,60	10,00	103,0	61	48,00
SPC0097-0485-ALU VHM/DLC	9,70	10,00	103,0	61	48,50
SPC0098-0490-ALU VHM/DLC	9,80	10,00	103,0	61	49,00
SPC0099-0495-ALU VHM/DLC	9,90	10,00	103,0	61	49,50
SPC0100-0500-ALU VHM/DLC	10,00	10,00	103,0	61	50,00
SPC0101-0505-ALU VHM/DLC	10,10	12,00	118,0	71	50,50
SPC0102-0510-ALU VHM/DLC	10,20	12,00	118,0	71	51,00
SPC0103-0515-ALU VHM/DLC	10,30	12,00	118,0	71	51,50
SPC0104-0520-ALU VHM/DLC	10,40	12,00	118,0	71	52,00
SPC0105-0525-ALU VHM/DLC	10,50	12,00	118,0	71	52,50
SPC0106-0530-ALU VHM/DLC	10,60	12,00	118,0	71	53,00
SPC0107-0535-ALU VHM/DLC	10,70	12,00	118,0	71	53,50
SPC0108-0540-ALU VHM/DLC	10,80	12,00	118,0	71	54,00
SPC0109-0545-ALU VHM/DLC	10,90	12,00	118,0	71	54,50
SPC0110-0550-ALU VHM/DLC	11,00	12,00	118,0	71	55,00
SPC0111-0555-ALU VHM/DLC	11,10	12,00	118,0	71	55,50
SPC0112-0560-ALU VHM/DLC	11,20	12,00	118,0	71	56,00
SPC0113-0565-ALU VHM/DLC	11,30	12,00	118,0	71	56,50
SPC0114-0570-ALU VHM/DLC	11,40	12,00	118,0	71	57,00
SPC0115-0575-ALU VHM/DLC	11,50	12,00	118,0	71	57,50
SPC0116-0580-ALU VHM/DLC	11,60	12,00	118,0	71	58,00
SPC0117-0585-ALU VHM/DLC	11,70	12,00	118,0	71	58,50
SPC0118-0590-ALU VHM/DLC	11,80	12,00	118,0	71	59,00
SPC0119-0595-ALU VHM/DLC	11,90	12,00	118,0	71	59,50
SPC0120-0600-ALU VHM/DLC	12,00	12,00	118,0	71	60,00
SPC0123-0615-ALU VHM/DLC	12,30	14,00	124,0	77	61,50
SPC0125-0625-ALU VHM/DLC	12,50	14,00	124,0	77	62,50
SPC0128-0640-ALU VHM/DLC	12,80	14,00	124,0	77	64,00
SPC0130-0650-ALU VHM/DLC	13,00	14,00	124,0	77	65,00
SPC0135-0675-ALU VHM/DLC	13,50	14,00	124,0	77	67,50
SPC0138-0690-ALU VHM/DLC	13,80	14,00	124,0	77	69,00
SPC0140-0700-ALU VHM/DLC	14,00	14,00	124,0	77	70,00
SPC0145-0725-ALU VHM/DLC	14,50	16,00	133,0	83	72,50
SPC0148-0740-ALU VHM/DLC	14,80	16,00	133,0	83	74,00

Bezeichnung Designation	D m7	d _A h6	l	l ₂	l ₄
SPC0150-0750-ALU VHM/DLC	15,00	16,00	133,0	83	75,00
SPC0155-0775-ALU VHM/DLC	15,50	16,00	133,0	83	77,50
SPC0158-0790-ALU VHM/DLC	15,80	16,00	133,0	83	79,00
SPC0160-0800-ALU VHM/DLC	16,00	16,00	133,0	83	80,00
SPC0165-0825-ALU VHM/DLC	16,50	18,00	143,0	93	82,50
SPC0168-0840-ALU VHM/DLC	16,80	18,00	143,0	93	84,00
SPC0170-0850-ALU VHM/DLC	17,00	18,00	143,0	93	85,00
SPC0175-0875-ALU VHM/DLC	17,50	18,00	143,0	93	87,50
SPC0178-0890-ALU VHM/DLC	17,80	18,00	143,0	93	89,00
SPC0180-0900-ALU VHM/DLC	18,00	18,00	143,0	93	90,00
SPC0185-0925-ALU VHM/DLC	18,50	20,00	153,0	101	92,50
SPC0190-0950-ALU VHM/DLC	19,00	20,00	153,0	101	95,00
SPC0195-0975-ALU VHM/DLC	19,50	20,00	153,0	101	97,50
SPC0198-0990-ALU VHM/DLC	19,80	20,00	153,0	101	99,00
SPC0200-1000-ALU VHM/DLC	20,00	20,00	153,0	101	100,00

Vollhartmetall-Spiralbohrer

Mittellange Ausführung, mit Innenkühlung



Solid carbide drills

Mid-length design, with through tool coolant

h6	HAK	1,5-20,0 mm	mit IK with ic	Seite Page 455-462
140°	30°	m7	TiAlN	Feinstkorn Ultra micro granulation
VA	5 xD			

Ausführung 5 x D für rostfreie Stähle / Execution 5 x D for stainless steel

Bezeichnung Designation	D m7	d _A h6	l	l ₂	l ₄
SPC0015-0075-VA VHM/TIALN	1,50	3,00	55,0	16	7,50
SPC0016-0080-VA VHM/TIALN	1,60	3,00	55,0	16	8,00
SPC0017-0085-VA VHM/TIALN	1,70	3,00	55,0	16	8,50
SPC0018-0090-VA VHM/TIALN	1,80	3,00	55,0	16	9,00
SPC0019-0095-VA VHM/TIALN	1,90	3,00	55,0	16	9,50
SPC0020-0100-VA VHM/TIALN	2,00	4,00	57,0	21	10,00
SPC0021-0105-VA VHM/TIALN	2,10	4,00	57,0	21	10,50
SPC0022-0110-VA VHM/TIALN	2,20	4,00	57,0	21	11,00
SPC0023-0115-VA VHM/TIALN	2,30	4,00	57,0	21	11,50
SPC0024-0120-VA VHM/TIALN	2,40	4,00	57,0	21	12,00
SPC0025-0125-VA VHM/TIALN	2,50	4,00	57,0	21	12,50
SPC0026-0130-VA VHM/TIALN	2,60	4,00	57,0	21	13,00
SPC0027-0135-VA VHM/TIALN	2,70	4,00	57,0	21	13,50
SPC0028-0140-VA VHM/TIALN	2,80	4,00	57,0	21	14,00
SPC0029-0145-VA VHM/TIALN	2,90	4,00	57,0	21	14,50
SPC0030-0150-VA VHM/TIALN	3,00	6,00	66,0	28	15,00
SPC0031-0155-VA VHM/TIALN	3,10	6,00	66,0	28	15,50
SPC0032-0160-VA VHM/TIALN	3,20	6,00	66,0	28	16,00
SPC0033-0165-VA VHM/TIALN	3,30	6,00	66,0	28	16,50
SPC0034-0170-VA VHM/TIALN	3,40	6,00	66,0	28	17,00
SPC0035-0175-VA VHM/TIALN	3,50	6,00	66,0	28	17,50
SPC0036-0180-VA VHM/TIALN	3,60	6,00	66,0	28	18,00
SPC0037-0185-VA VHM/TIALN	3,70	6,00	66,0	28	18,50
SPC0038-0190-VA VHM/TIALN	3,80	6,00	74,0	36	19,00
SPC0039-0195-VA VHM/TIALN	3,90	6,00	74,0	36	19,50
SPC0040-0200-VA VHM/TIALN	4,00	6,00	74,0	36	20,00
SPC0041-0205-VA VHM/TIALN	4,10	6,00	74,0	36	20,50
SPC0042-0210-VA VHM/TIALN	4,20	6,00	74,0	36	21,00
SPC0043-0215-VA VHM/TIALN	4,30	6,00	74,0	36	21,50
SPC0044-0220-VA VHM/TIALN	4,40	6,00	74,0	36	22,00
SPC0045-0225-VA VHM/TIALN	4,50	6,00	74,0	36	22,50
SPC0046-0230-VA VHM/TIALN	4,60	6,00	74,0	36	23,00
SPC0047-0235-VA VHM/TIALN	4,70	6,00	74,0	36	23,50
SPC0048-0240-VA VHM/TIALN	4,80	6,00	82,0	44	24,00
SPC0049-0245-VA VHM/TIALN	4,90	6,00	82,0	44	24,50
SPC0050-0250-VA VHM/TIALN	5,00	6,00	82,0	44	25,00
SPC0051-0255-VA VHM/TIALN	5,10	6,00	82,0	44	25,50
SPC0052-0260-VA VHM/TIALN	5,20	6,00	82,0	44	26,00
SPC0053-0265-VA VHM/TIALN	5,30	6,00	82,0	44	26,50
SPC0054-0270-VA VHM/TIALN	5,40	6,00	82,0	44	27,00
SPC0055-0275-VA VHM/TIALN	5,50	6,00	82,0	44	27,50
SPC0056-0280-VA VHM/TIALN	5,60	6,00	82,0	44	28,00

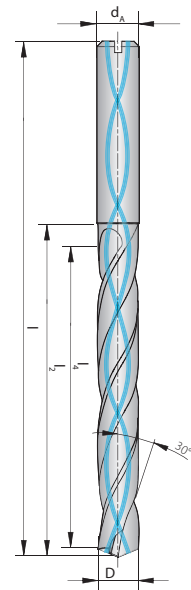

Vollhartmetall-Spiralbohrer

Mittellange Ausführung, mit Innenkühlung

Solid carbide drills

Mid-length design, with through tool coolant

Ausführung 5 x D für rostfreie Stähle / Execution 5 x D for stainless steel

Bezeichnung Designation	D m7	d _A h6	l	l ₂	l ₄
SPC0057-0285-VA VHM/TIALN	5,70	6,00	82,0	44	28,50
SPC0058-0290-VA VHM/TIALN	5,80	6,00	82,0	44	29,00
SPC0059-0295-VA VHM/TIALN	5,90	6,00	82,0	44	29,50
SPC0060-0300-VA VHM/TIALN	6,00	6,00	82,0	44	30,00
SPC0061-0305-VA VHM/TIALN	6,10	8,00	91,0	53	30,50
SPC0062-0310-VA VHM/TIALN	6,20	8,00	91,0	53	31,00
SPC0063-0315-VA VHM/TIALN	6,30	8,00	91,0	53	31,50
SPC0064-0320-VA VHM/TIALN	6,40	8,00	91,0	53	32,00
SPC0065-0325-VA VHM/TIALN	6,50	8,00	91,0	53	32,50
SPC0066-0330-VA VHM/TIALN	6,60	8,00	91,0	53	33,00
SPC0067-0335-VA VHM/TIALN	6,70	8,00	91,0	53	33,50
SPC0068-0340-VA VHM/TIALN	6,80	8,00	91,0	53	34,00
SPC0069-0345-VA VHM/TIALN	6,90	8,00	91,0	53	34,50
SPC0070-0350-VA VHM/TIALN	7,00	8,00	91,0	53	35,00
SPC0071-0355-VA VHM/TIALN	7,10	8,00	91,0	53	35,50
SPC0072-0360-VA VHM/TIALN	7,20	8,00	91,0	53	36,00
SPC0073-0365-VA VHM/TIALN	7,30	8,00	91,0	53	36,50
SPC0074-0370-VA VHM/TIALN	7,40	8,00	91,0	53	37,00
SPC0075-0375-VA VHM/TIALN	7,50	8,00	91,0	53	37,50
SPC00755-0378-VA VHM/TIALN	7,55	8,00	91,0	53	37,80
SPC0076-0380-VA VHM/TIALN	7,60	8,00	91,0	53	38,00
SPC00765-0383-VA VHM/TIALN	7,65	8,00	91,0	53	38,30
SPC0077-0385-VA VHM/TIALN	7,70	8,00	91,0	53	38,50
SPC0078-0390-VA VHM/TIALN	7,80	8,00	91,0	53	39,00
SPC0079-0395-VA VHM/TIALN	7,90	8,00	91,0	53	39,50
SPC0080-0400-VA VHM/TIALN	8,00	8,00	91,0	53	40,00
SPC0081-0405-VA VHM/TIALN	8,10	10,00	103,0	61	40,50
SPC0082-0410-VA VHM/TIALN	8,20	10,00	103,0	61	41,00
SPC0083-0415-VA VHM/TIALN	8,30	10,00	103,0	61	41,50
SPC0084-0420-VA VHM/TIALN	8,40	10,00	103,0	61	42,00
SPC0085-0425-VA VHM/TIALN	8,50	10,00	103,0	61	42,50
SPC0086-0430-VA VHM/TIALN	8,60	10,00	103,0	61	43,00
SPC0087-0435-VA VHM/TIALN	8,70	10,00	103,0	61	43,50
SPC0088-0440-VA VHM/TIALN	8,80	10,00	103,0	61	44,00
SPC0089-0445-VA VHM/TIALN	8,90	10,00	103,0	61	44,50
SPC0090-0450-VA VHM/TIALN	9,00	10,00	103,0	61	45,00
SPC0091-0455-VA VHM/TIALN	9,10	10,00	103,0	61	45,50
SPC0092-0460-VA VHM/TIALN	9,20	10,00	103,0	61	46,00
SPC00925-0463-VA VHM/TIALN	9,25	10,00	103,0	61	46,30
SPC0093-0465-VA VHM/TIALN	9,30	10,00	103,0	61	46,50
SPC0094-0470-VA VHM/TIALN	9,40	10,00	103,0	61	47,00
SPC0095-0475-VA VHM/TIALN	9,50	10,00	103,0	61	47,50
SPC00955-0488-VA VHM/TIALN	9,55	10,00	103,0	61	48,80
SPC0096-0480-VA VHM/TIALN	9,60	10,00	103,0	61	48,00
SPC0097-0485-VA VHM/TIALN	9,70	10,00	103,0	61	48,50
SPC0098-0490-VA VHM/TIALN	9,80	10,00	103,0	61	49,00
SPC0099-0495-VA VHM/TIALN	9,90	10,00	103,0	61	49,50
SPC0100-0500-VA VHM/TIALN	10,00	10,00	103,0	61	50,00
SPC0101-0505-VA VHM/TIALN	10,10	12,00	118,0	71	50,50
SPC0102-0510-VA VHM/TIALN	10,20	12,00	118,0	71	51,00
SPC0103-0515-VA VHM/TIALN	10,30	12,00	118,0	71	51,50
SPC0104-0520-VA VHM/TIALN	10,40	12,00	118,0	71	52,00
SPC0105-0525-VA VHM/TIALN	10,50	12,00	118,0	71	52,50
SPC0106-0530-VA VHM/TIALN	10,60	12,00	118,0	71	53,00
SPC0107-0535-VA VHM/TIALN	10,70	12,00	118,0	71	53,50
SPC0108-0540-VA VHM/TIALN	10,80	12,00	118,0	71	54,00
SPC0109-0545-VA VHM/TIALN	10,90	12,00	118,0	71	54,50
SPC0110-0550-VA VHM/TIALN	11,00	12,00	118,0	71	55,00

Bezeichnung Designation	D m7	d _A h6	l	l ₂	l ₄
SPC0111-0555-VA VHM/TIALN	11,10	12,00	118,0	71	55,50
SPC0112-0560-VA VHM/TIALN	11,20	12,00	118,0	71	56,00
SPC0113-0565-VA VHM/TIALN	11,30	12,00	118,0	71	56,50
SPC0114-0570-VA VHM/TIALN	11,40	12,00	118,0	71	57,00
SPC0115-0575-VA VHM/TIALN	11,50	12,00	118,0	71	57,50
SPC0116-0580-VA VHM/TIALN	11,60	12,00	118,0	71	58,00
SPC0117-0585-VA VHM/TIALN	11,70	12,00	118,0	71	58,50
SPC0118-0590-VA VHM/TIALN	11,80	12,00	118,0	71	59,00
SPC0119-0595-VA VHM/TIALN	11,90	12,00	118,0	71	59,50
SPC0120-0600-VA VHM/TIALN	12,00	12,00	118,0	71	60,00
SPC0125-0625-VA VHM/TIALN	12,50	14,00	124,0	77	62,50
SPC0128-0640-VA VHM/TIALN	12,80	14,00	124,0	77	64,00
SPC0130-0650-VA VHM/TIALN	13,00	14,00	124,0	77	65,00
SPC0135-0675-VA VHM/TIALN	13,50	14,00	124,0	77	67,50
SPC0140-0700-VA VHM/TIALN	14,00	14,00	124,0	77	70,00
SPC0145-0725-VA VHM/TIALN	14,50	16,00	133,0	83	72,50
SPC0150-0750-VA VHM/TIALN	15,00	16,00	133,0	83	75,00
SPC0155-0775-VA VHM/TIALN	15,50	16,00	133,0	83	77,50
SPC0160-0800-VA VHM/TIALN	16,00	16,00	133,0	83	80,00
SPC0165-0825-VA VHM/TIALN	16,50	18,00	143,0	93	82,50
SPC0170-0850-VA VHM/TIALN	17,00	18,00	143,0	93	85,00
SPC0175-0875-VA VHM/TIALN	17,50	18,00	143,0	93	87,50
SPC0180-0900-VA VHM/TIALN	18,00	18,00	143,0	93	90,00
SPC0185-0925-VA VHM/TIALN	18,50	20,00	153,0	101	92,50
SPC0190-0950-VA VHM/TIALN	19,00	20,00	153,0	101	95,00
SPC0195-0975-VA VHM/TIALN	19,50	20,00	153,0	101	97,50
SPC0200-1000-VA VHM/TIALN	20,00	20,00	153,0	101	100,00

Vollhartmetall-Spiralbohrer

Mittellange Ausführung, ohne Innenkühlung



Solid carbide drills

Mid-length design, without through tool coolant

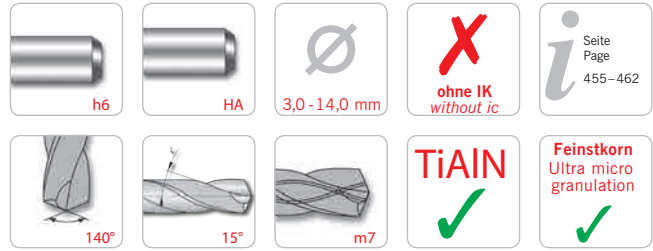

Mittellange Ausführung für gehärtete Stähle / Mid-length execution for hardened steel

Bezeichnung Designation	D m7	d _A h6	l	l ₂	l ₄
SP0030-0150-H VHM/TIALN	3,00	3,00	46,0	16	15,00
SP0032-0160-H VHM/TIALN	3,20	4,00	48,0	18	16,00
SP0033-0165-H VHM/TIALN	3,30	4,00	48,0	18	16,50
SP0034-0170-H VHM/TIALN	3,40	4,00	50,0	20	17,00
SP0035-0175-H VHM/TIALN	3,50	4,00	50,0	20	17,50
SP0040-0200-H VHM/TIALN	4,00	4,00	52,0	22	20,00
SP0042-0210-H VHM/TIALN	4,20	6,00	65,0	25	21,00
SP0043-0215-H VHM/TIALN	4,30	6,00	68,0	28	21,50
SP0044-0220-H VHM/TIALN	4,40	6,00	68,0	28	22,00
SP0045-0225-H VHM/TIALN	4,50	6,00	68,0	28	22,50
SP0050-0250-H VHM/TIALN	5,00	6,00	72,0	32	25,00
SP0051-0255-H VHM/TIALN	5,10	6,00	72,0	32	25,50
SP0052-0260-H VHM/TIALN	5,20	6,00	72,0	32	26,00
SP0055-0275-H VHM/TIALN	5,50	6,00	75,0	35	27,50
SP0060-0300-H VHM/TIALN	6,00	6,00	75,0	35	30,00
SP0065-0325-H VHM/TIALN	6,50	8,00	80,0	40	32,50
SP0068-0340-H VHM/TIALN	6,80	8,00	85,0	45	34,00
SP0069-0345-H VHM/TIALN	6,90	8,00	85,0	45	34,50
SP0070-0350-H VHM/TIALN	7,00	8,00	85,0	45	35,00
SP0075-0375-H VHM/TIALN	7,50	8,00	85,0	45	37,50
SP0080-0400-H VHM/TIALN	8,00	8,00	98,0	50	40,00
SP0085-0425-H VHM/TIALN	8,50	10,00	98,0	50	42,50
SP0086-0430-H VHM/TIALN	8,60	10,00	105,0	57	43,00
SP0088-0440-H VHM/TIALN	8,80	10,00	105,0	57	44,00
SP0090-0450-H VHM/TIALN	9,00	10,00	105,0	57	45,00
SP0095-0475-H VHM/TIALN	9,50	10,00	105,0	57	47,50
SP0100-0500-H VHM/TIALN	10,00	10,00	111,0	63	50,00
SP0102-0510-H VHM/TIALN	10,20	12,00	111,0	63	51,00
SP0103-0515-H VHM/TIALN	10,30	12,00	111,0	63	51,50
SP0105-0525-H VHM/TIALN	10,50	12,00	111,0	63	52,50
SP0108-0540-H VHM/TIALN	10,80	12,00	119,0	71	54,00
SP0110-0550-H VHM/TIALN	11,00	12,00	119,0	71	55,00
SP0115-0575-H VHM/TIALN	11,50	12,00	119,0	71	57,50
SP0120-0600-H VHM/TIALN	12,00	12,00	119,0	71	60,00
SP0140-0700-H VHM/TIALN	14,00	14,00	125,0	71	70,00

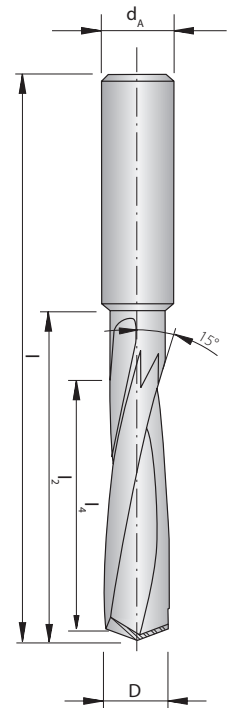

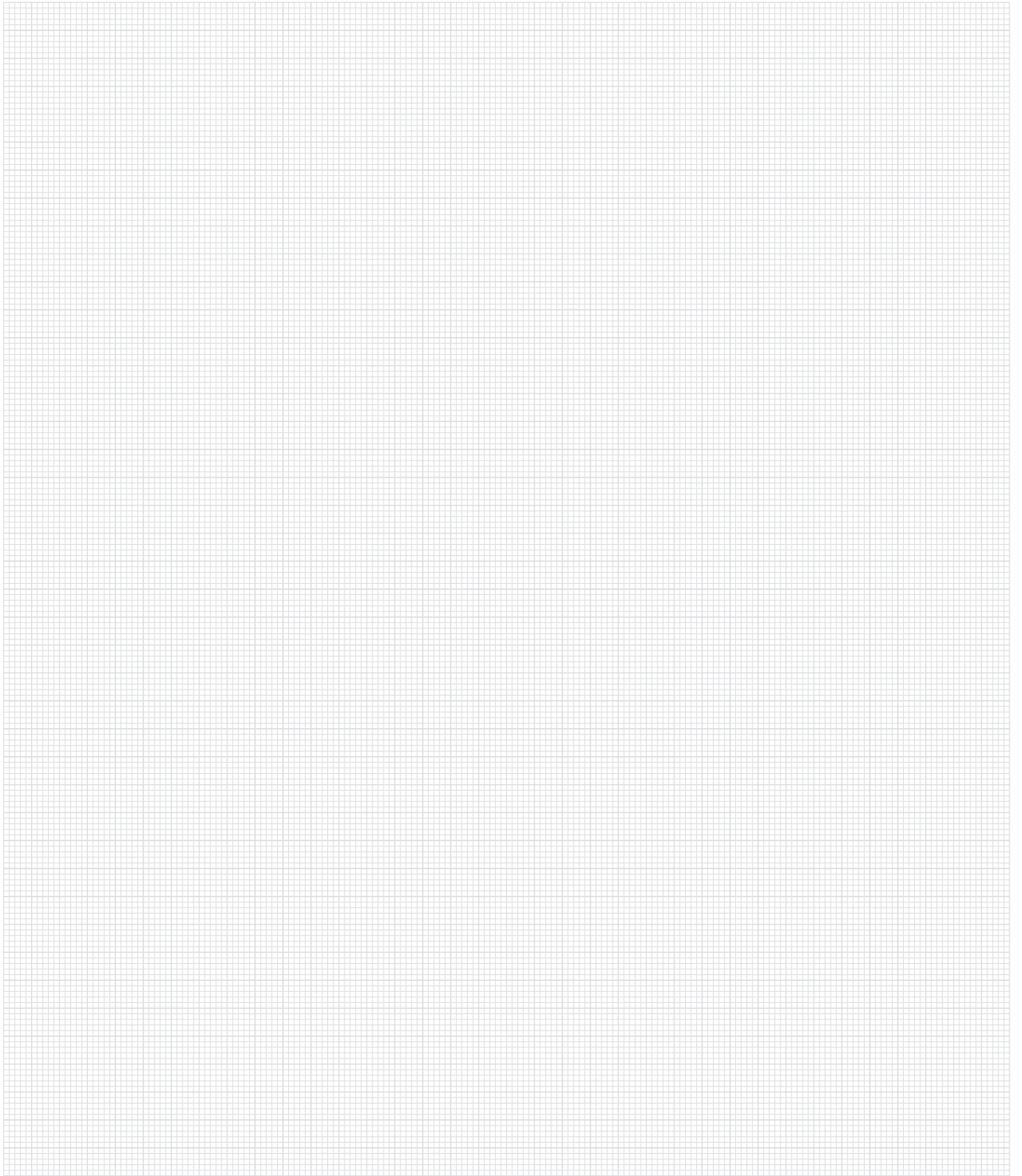

ARNO[®]
WERKZEUGE

Weitere Informationen finden Sie unter:
For more information see:

www.arno.de

Vollhartmetall-Spiralbohrer

Lange Ausführung, ohne Innenkühlung



Solid carbide drills

Long design, without through tool coolant

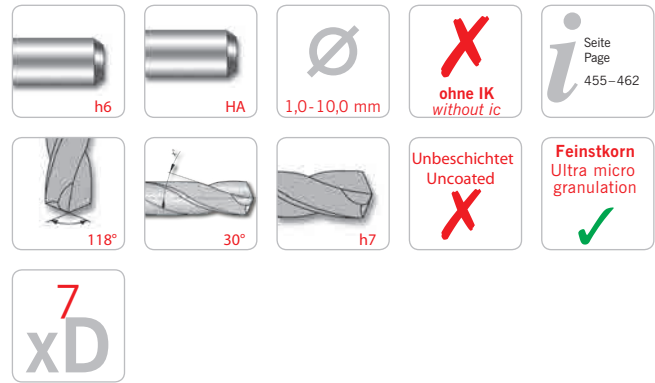

Ausführung 7 x D / Execution 7 x D

Bezeichnung Designation	D h7	d _A h6	l	l ₂	l ₄
SP0010-0070 VHM/FK	1,00	1,00	34,0	12	7,00
SP0011-0077 VHM/FK	1,10	1,10	36,0	14	7,70
SP0012-0084 VHM/FK	1,20	1,20	38,0	16	8,40
SP0013-0091 VHM/FK	1,30	1,30	38,0	16	9,10
SP0014-0098 VHM/FK	1,40	1,40	40,0	18	9,80
SP0015-0105 VHM/FK	1,50	1,50	40,0	18	10,50
SP0016-0112 VHM/FK	1,60	1,60	43,0	20	11,20
SP0017-0119 VHM/FK	1,70	1,70	43,0	20	11,90
SP0018-0126 VHM/FK	1,80	1,80	46,0	22	12,60
SP0019-0133 VHM/FK	1,90	1,90	46,0	22	13,30
SP0020-0140 VHM/FK	2,00	2,00	49,0	24	14,00
SP0021-0147 VHM/FK	2,10	2,10	49,0	24	14,70
SP0022-0154 VHM/FK	2,20	2,20	53,0	27	15,40
SP0023-0161 VHM/FK	2,30	2,30	53,0	27	16,10
SP0024-0168 VHM/FK	2,40	2,40	57,0	30	16,80
SP0025-0175 VHM/FK	2,50	2,50	57,0	30	17,50
SP0026-0182 VHM/FK	2,60	2,60	57,0	30	18,20
SP0027-0189 VHM/FK	2,70	2,70	61,0	33	18,90
SP0028-0196 VHM/FK	2,80	2,80	61,0	33	19,60
SP0029-0203 VHM/FK	2,90	2,90	61,0	33	20,30
SP0030-0210 VHM/FK	3,00	3,00	61,0	33	21,00
SP0031-0217 VHM/FK	3,10	3,10	65,0	36	21,70
SP0032-0224 VHM/FK	3,20	3,20	65,0	36	22,40
SP0033-0231 VHM/FK	3,30	3,30	65,0	36	23,10
SP0034-0238 VHM/FK	3,40	3,40	70,0	39	23,80
SP0035-0245 VHM/FK	3,50	3,50	70,0	39	24,50
SP0036-0252 VHM/FK	3,60	3,60	70,0	39	25,20
SP0037-0259 VHM/FK	3,70	3,70	70,0	39	25,90
SP0038-0266 VHM/FK	3,80	3,80	75,0	43	26,60
SP0039-0273 VHM/FK	3,90	3,90	75,0	43	27,30
SP0040-0280 VHM/FK	4,00	4,00	75,0	43	28,00
SP0041-0287 VHM/FK	4,10	4,10	75,0	43	28,70
SP0042-0294 VHM/FK	4,20	4,20	75,0	43	29,40
SP0043-0301 VHM/FK	4,30	4,30	80,0	47	30,10
SP0044-0308 VHM/FK	4,40	4,40	80,0	47	30,80
SP0045-0315 VHM/FK	4,50	4,50	80,0	47	31,50
SP0046-0322 VHM/FK	4,60	4,60	80,0	47	32,20
SP0047-0329 VHM/FK	4,70	4,70	80,0	47	32,90
SP0048-0336 VHM/FK	4,80	4,80	86,0	52	33,60
SP0049-0343 VHM/FK	4,90	4,90	86,0	52	34,30
SP0050-0350 VHM/FK	5,00	5,00	86,0	52	35,00
SP0051-0357 VHM/FK	5,10	5,10	86,0	52	35,70

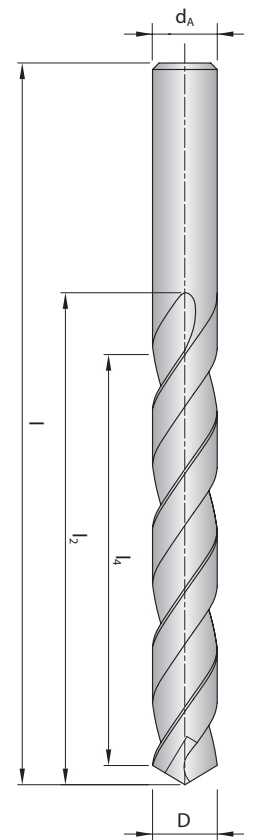

Vollhartmetall-Spiralbohrer

Lange Ausführung, ohne Innenkühlung

Solid carbide drills

Long design, without through tool coolant

Ausführung 7 x D / Execution 7 x D

Bezeichnung Designation	D h7	d _A h6	l	l ₂	l ₄
SP0052-0364 VHM/FK	5,20	5,20	86,0	52	36,40
SP0053-0371 VHM/FK	5,30	5,30	86,0	52	37,10
SP0054-0378 VHM/FK	5,40	5,40	93,0	57	37,80
SP0055-0385 VHM/FK	5,50	5,50	93,0	57	38,50
SP0056-0392 VHM/FK	5,60	5,60	93,0	57	39,20
SP0057-0399 VHM/FK	5,70	5,70	93,0	57	39,90
SP0058-0406 VHM/FK	5,80	5,80	93,0	57	40,60
SP0059-0413 VHM/FK	5,90	5,90	93,0	57	41,30
SP0060-0420 VHM/FK	6,00	6,00	93,0	57	42,00
SP0061-0427 VHM/FK	6,10	6,10	101,0	63	42,70
SP0062-0434 VHM/FK	6,20	6,20	101,0	63	43,40
SP0063-0441 VHM/FK	6,30	6,30	101,0	63	44,10
SP0064-0448 VHM/FK	6,40	6,40	101,0	63	44,80
SP0065-0455 VHM/FK	6,50	6,50	101,0	63	45,50
SP0068-0476 VHM/FK	6,80	6,80	109,0	69	47,60
SP0070-0490 VHM/FK	7,00	7,00	109,0	69	49,00
SP0080-0560 VHM/FK	8,00	8,00	117,0	75	56,00
SP0085-0595 VHM/FK	8,50	8,50	117,0	75	59,50
SP0100-0700 VHM/FK	10,00	10,00	133,0	87	70,00

Vollhartmetall-Spiralbohrer

Lange Ausführung, ohne Innenkühlung



Solid carbide drills

Long design, without through tool coolant

h6	HA	1,0-10,0 mm	ohne IK without ic	Seite Page 455-462
118°	30°	h7	TiAlN	Feinstkorn Ultra micro granulation

Ausführung 7 x D / Execution 7 x D

Bezeichnung Designation	D h7	d _A h6	l	l ₂	l ₄
SP0010-0070 VHM/TIALN	1,00	1,00	34,0	12	7,00
SP0011-0077 VHM/TIALN	1,10	1,10	36,0	14	7,70
SP0012-0084 VHM/TIALN	1,20	1,20	38,0	16	8,40
SP0013-0091 VHM/TIALN	1,30	1,30	38,0	16	9,10
SP0014-0098 VHM/TIALN	1,40	1,40	40,0	18	9,80
SP0015-0105 VHM/TIALN	1,50	1,50	40,0	18	10,50
SP0016-0112 VHM/TIALN	1,60	1,60	43,0	20	11,20
SP0017-0119 VHM/TIALN	1,70	1,70	43,0	20	11,90
SP0018-0126 VHM/TIALN	1,80	1,80	46,0	22	12,60
SP0019-0133 VHM/TIALN	1,90	1,90	46,0	22	13,30
SP0020-0140 VHM/TIALN	2,00	2,00	49,0	24	14,00
SP0021-0147 VHM/TIALN	2,10	2,10	49,0	24	14,70
SP0022-0154 VHM/TIALN	2,20	2,20	53,0	27	15,40
SP0023-0161 VHM/TIALN	2,30	2,30	53,0	27	16,10
SP0024-0168 VHM/TIALN	2,40	2,40	57,0	30	16,80
SP0025-0175 VHM/TIALN	2,50	2,50	57,0	30	17,50
SP0026-0182 VHM/TIALN	2,60	2,60	57,0	30	18,20
SP0027-0189 VHM/TIALN	2,70	2,70	61,0	33	18,90
SP0028-0196 VHM/TIALN	2,80	2,80	61,0	33	19,60
SP0029-0203 VHM/TIALN	2,90	2,90	61,0	33	20,30
SP0030-0210 VHM/TIALN	3,00	3,00	61,0	33	21,00
SP0031-0217 VHM/TIALN	3,10	3,10	65,0	36	21,70
SP0032-0224 VHM/TIALN	3,20	3,20	65,0	36	22,40
SP0033-0231 VHM/TIALN	3,30	3,30	65,0	36	23,10
SP0034-0238 VHM/TIALN	3,40	3,40	70,0	39	23,80
SP0035-0245 VHM/TIALN	3,50	3,50	70,0	39	24,50
SP0036-0252 VHM/TIALN	3,60	3,60	70,0	39	25,20
SP0037-0259 VHM/TIALN	3,70	3,70	70,0	39	25,90
SP0038-0266 VHM/TIALN	3,80	3,80	75,0	43	26,60
SP0039-0273 VHM/TIALN	3,90	3,90	75,0	43	27,30
SP0040-0280 VHM/TIALN	4,00	4,00	75,0	43	28,00
SP0041-0287 VHM/TIALN	4,10	4,10	75,0	43	28,70
SP0042-0294 VHM/TIALN	4,20	4,20	75,0	43	29,40
SP0043-0301 VHM/TIALN	4,30	4,30	80,0	47	30,10
SP0044-0308 VHM/TIALN	4,40	4,40	80,0	47	30,80
SP0045-0315 VHM/TIALN	4,50	4,50	80,0	47	31,50
SP0046-0322 VHM/TIALN	4,60	4,60	80,0	47	32,20
SP0047-0329 VHM/TIALN	4,70	4,70	80,0	47	32,90
SP0048-0336 VHM/TIALN	4,80	4,80	86,0	52	33,60
SP0049-0343 VHM/TIALN	4,90	4,90	86,0	52	34,30
SP0050-0350 VHM/TIALN	5,00	5,00	86,0	52	35,00
SP0051-0357 VHM/TIALN	5,10	5,10	86,0	52	35,70

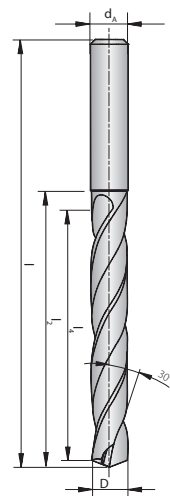



















Vollhartmetall-Spiralbohrer

Lange Ausführung, ohne Innenkühlung

Solid carbide drills

Long design, without through tool coolant

Ausführung 7 x D / Execution 7 x D

Bezeichnung Designation	D h7	d _A h6	l	l ₂	l ₄
SP0052-0364 VHM/TIALN 	5,20	5,20	86,0	52	36,40
SP0053-0371 VHM/TIALN 	5,30	5,30	86,0	52	37,10
SP0054-0378 VHM/TIALN 	5,40	5,40	93,0	57	37,80
SP0055-0385 VHM/TIALN 	5,50	5,50	93,0	57	38,50
SP0056-0392 VHM/TIALN 	5,60	5,60	93,0	57	39,20
SP0057-0399 VHM/TIALN 	5,70	5,70	93,0	57	39,90
SP0058-0406 VHM/TIALN 	5,80	5,80	93,0	57	40,60
SP0059-0413 VHM/TIALN 	5,90	5,90	93,0	57	41,30
SP0060-0420 VHM/TIALN 	6,00	6,00	93,0	57	42,00
SP0061-0427 VHM/TIALN 	6,10	6,10	101,0	63	42,70
SP0062-0434 VHM/TIALN 	6,20	6,20	101,0	63	43,40
SP0063-0441 VHM/TIALN 	6,30	6,30	101,0	63	44,10
SP0064-0448 VHM/TIALN 	6,40	6,40	101,0	63	44,80
SP0065-0455 VHM/TIALN 	6,50	6,50	101,0	63	45,50
SP0068-0476 VHM/TIALN 	6,80	6,80	109,0	69	47,60
SP0070-0490 VHM/TIALN 	7,00	7,00	109,0	69	49,00
SP0080-0560 VHM/TIALN 	8,00	8,00	117,0	75	56,00
SP0085-0595 VHM/TIALN 	8,50	8,50	117,0	75	59,50
SP0100-0700 VHM/TIALN 	10,00	10,00	133,0	87	70,00

PM-HSS Spiralbohrer

Lange Ausführung, ohne Innenkühlung



Powder metal drills

Long design, without through tool coolant

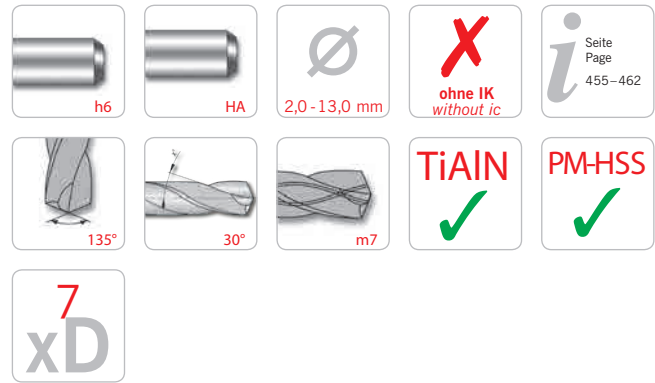

Ausführung 7 x D Pulvermetallurgisches HSS / Execution 7 x D powder metal drill

Bezeichnung Designation	D m7	d _A h6	l	l ₂	l ₄
SP0020-0140-PM TIALN	2,00	3,00	56,0	24	14,00
SP0021-0147-PM TIALN	2,10	3,00	56,0	24	14,70
SP0022-0154-PM TIALN	2,20	3,00	56,0	25	15,40
SP0023-0161-PM TIALN	2,30	3,00	56,0	25	16,10
SP0024-0168-PM TIALN	2,40	3,00	61,0	30	16,80
SP0025-0175-PM TIALN	2,50	3,00	61,0	30	17,50
SP0026-0182-PM TIALN	2,60	3,00	61,0	30	18,20
SP0027-0189-PM TIALN	2,70	3,00	64,0	33	18,90
SP0028-0196-PM TIALN	2,80	3,00	64,0	33	19,60
SP0029-0203-PM TIALN	2,90	3,00	64,0	33	20,30
SP0030-0210-PM TIALN	3,00	3,00	64,0	33	21,00
SP0031-0217-PM TIALN	3,10	4,00	68,0	36	21,70
SP0032-0224-PM TIALN	3,20	4,00	68,0	36	22,40
SP0033-0231-PM TIALN	3,30	4,00	68,0	36	23,10
SP0034-0238-PM TIALN	3,40	4,00	71,0	39	23,80
SP0035-0245-PM TIALN	3,50	4,00	71,0	39	24,50
SP0036-0252-PM TIALN	3,60	4,00	71,0	39	25,20
SP0037-0259-PM TIALN	3,70	4,00	71,0	39	25,90
SP0038-0266-PM TIALN	3,80	4,00	75,0	43	26,60
SP0039-0273-PM TIALN	3,90	4,00	75,0	43	27,30
SP0040-0280-PM TIALN	4,00	4,00	75,0	43	28,00
SP0041-0287-PM TIALN	4,10	6,00	85,0	43	28,70
SP0042-0294-PM TIALN	4,20	6,00	85,0	43	29,40
SP0043-0301-PM TIALN	4,30	6,00	89,0	47	30,10
SP0044-0308-PM TIALN	4,40	6,00	89,0	47	30,80
SP0045-0315-PM TIALN	4,50	6,00	89,0	47	31,50
SP0046-0322-PM TIALN	4,60	6,00	89,0	47	32,20
SP0047-0329-PM TIALN	4,70	6,00	89,0	47	32,90
SP0048-0336-PM TIALN	4,80	6,00	94,0	52	33,60
SP0049-0343-PM TIALN	4,90	6,00	94,0	52	34,30
SP0050-0350-PM TIALN	5,00	6,00	94,0	52	35,00
SP0051-0357-PM TIALN	5,10	6,00	94,0	52	35,70
SP0052-0364-PM TIALN	5,20	6,00	94,0	52	36,40
SP0053-0371-PM TIALN	5,30	6,00	94,0	52	37,10
SP0054-0378-PM TIALN	5,40	6,00	99,0	57	37,80
SP0055-0385-PM TIALN	5,50	6,00	99,0	57	38,50
SP0056-0392-PM TIALN	5,60	6,00	99,0	57	39,20
SP0057-0399-PM TIALN	5,70	6,00	99,0	57	39,90
SP0058-0406-PM TIALN	5,80	6,00	99,0	57	40,60
SP0059-0413-PM TIALN	5,90	6,00	99,0	57	41,30
SP0060-0420-PM TIALN	6,00	6,00	99,0	57	42,00
SP0061-0427-PM TIALN	6,10	8,00	107,0	63	42,70

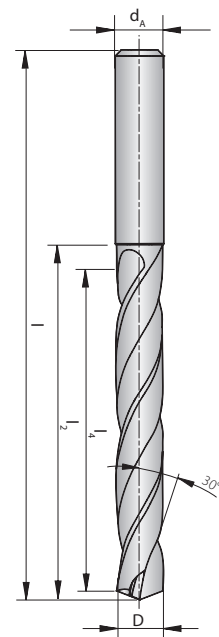

PM-HSS Spiralbohrer

Lange Ausführung, ohne Innenkühlung

Powder metal drills

Long design, without through tool coolant

Ausführung 7 x D Pulvermetallurgisches HSS / Execution 7 x D powder metal drill

Bezeichnung Designation	D m7	d _A h6	l	l ₂	l ₄
SP0062-0434-PM TIALN	6,20	8,00	107,0	63	43,40
SP0063-0441-PM TIALN	6,30	8,00	107,0	63	44,10
SP0064-0448-PM TIALN	6,40	8,00	107,0	63	44,80
SP0065-0455-PM TIALN	6,50	8,00	107,0	63	45,50
SP0066-0462-PM TIALN	6,60	8,00	107,0	63	46,20
SP0067-0469-PM TIALN	6,70	8,00	107,0	63	46,90
SP0068-0476-PM TIALN	6,80	8,00	113,0	69	47,60
SP0069-0483-PM TIALN	6,90	8,00	113,0	69	48,30
SP0070-0490-PM TIALN	7,00	8,00	113,0	69	49,00
SP0071-0497-PM TIALN	7,10	8,00	113,0	69	49,70
SP0072-0504-PM TIALN	7,20	8,00	113,0	69	50,40
SP0073-0511-PM TIALN	7,30	8,00	113,0	69	51,10
SP0074-0518-PM TIALN	7,40	8,00	113,0	69	51,80
SP0075-0525-PM TIALN	7,50	8,00	113,0	69	52,50
SP0076-0532-PM TIALN	7,60	8,00	119,0	75	53,20
SP0077-0539-PM TIALN	7,70	8,00	119,0	75	53,90
SP0078-0546-PM TIALN	7,80	8,00	119,0	75	54,60
SP0079-0553-PM TIALN	7,90	8,00	119,0	75	55,30
SP0080-0560-PM TIALN	8,00	8,00	119,0	75	56,00
SP0081-0567-PM TIALN	8,10	10,00	125,0	75	56,70
SP0082-0574-PM TIALN	8,20	10,00	125,0	75	57,40
SP0083-0581-PM TIALN	8,30	10,00	125,0	75	58,10
SP0084-0588-PM TIALN	8,40	10,00	125,0	75	58,80
SP0085-0595-PM TIALN	8,50	10,00	125,0	75	59,50
SP0086-0602-PM TIALN	8,60	10,00	131,0	81	60,20
SP0087-0609-PM TIALN	8,70	10,00	131,0	81	60,90
SP0088-0616-PM TIALN	8,80	10,00	131,0	81	61,60
SP0089-0623-PM TIALN	8,90	10,00	131,0	81	62,30
SP0090-0630-PM TIALN	9,00	10,00	131,0	81	63,00
SP0091-0637-PM TIALN	9,10	10,00	131,0	81	63,70
SP0092-0644-PM TIALN	9,20	10,00	131,0	81	64,40
SP0093-0651-PM TIALN	9,30	10,00	131,0	81	65,10
SP0094-0658-PM TIALN	9,40	10,00	131,0	81	65,80
SP0095-0665-PM TIALN	9,50	10,00	131,0	81	66,50
SP0096-0672-PM TIALN	9,60	10,00	137,0	87	67,20
SP0097-0679-PM TIALN	9,70	10,00	137,0	87	67,90
SP0098-0686-PM TIALN	9,80	10,00	137,0	87	68,60
SP0099-0693-PM TIALN	9,90	10,00	137,0	87	69,30
SP0100-0700-PM TIALN	10,00	10,00	137,0	87	70,00
SP0101-0707-PM TIALN	10,10	12,00	144,0	87	70,70
SP0102-0714-PM TIALN	10,20	12,00	144,0	87	71,40
SP0103-0721-PM TIALN	10,30	12,00	144,0	87	72,10
SP0104-0728-PM TIALN	10,40	12,00	144,0	87	72,80
SP0105-0735-PM TIALN	10,50	12,00	144,0	87	73,50
SP0106-0742-PM TIALN	10,60	12,00	144,0	87	74,20
SP0107-0749-PM TIALN	10,70	12,00	151,0	94	74,90
SP0108-0756-PM TIALN	10,80	12,00	151,0	94	75,60
SP0109-0763-PM TIALN	10,90	12,00	151,0	94	76,30
SP0110-0770-PM TIALN	11,00	12,00	151,0	94	77,00
SP0111-0777-PM TIALN	11,10	12,00	151,0	94	77,70
SP0112-0784-PM TIALN	11,20	12,00	151,0	94	78,40
SP0113-0791-PM TIALN	11,30	12,00	151,0	94	79,10
SP0114-0798-PM TIALN	11,40	12,00	151,0	94	79,80
SP0115-0805-PM TIALN	11,50	12,00	151,0	94	80,50
SP0116-0812-PM TIALN	11,60	12,00	151,0	94	81,20
SP0117-0819-PM TIALN	11,70	12,00	151,0	94	81,90
SP0118-0826-PM TIALN	11,80	12,00	151,0	94	82,60
SP0119-0833-PM TIALN	11,90	12,00	158,0	101	83,30

Bezeichnung Designation	D m7	d _A h6	l	l ₂	l ₄
SP0120-0840-PM TIALN	12,00	12,00	158,0	101	84,00
SP0121-0847-PM TIALN	12,10	12,00	158,0	101	84,70
SP0122-0854-PM TIALN	12,20	12,00	158,0	101	85,40
SP0123-0861-PM TIALN	12,30	12,00	158,0	101	86,10
SP0124-0868-PM TIALN	12,40	12,00	158,0	101	86,80
SP0125-0875-PM TIALN	12,50	12,00	158,0	101	87,50
SP0126-0882-PM TIALN	12,60	12,00	158,0	101	88,20
SP0127-0889-PM TIALN	12,70	12,00	158,0	101	88,90
SP0128-0896-PM TIALN	12,80	12,00	158,0	101	89,60
SP0129-0903-PM TIALN	12,90	12,00	158,0	101	90,30
SP0130-0910-PM TIALN	13,00	12,00	158,0	101	91,00

Vollhartmetall-Spiralbohrer

Lange Ausführung, mit Innenkühlung



Solid carbide drills

Long design, with through tool coolant

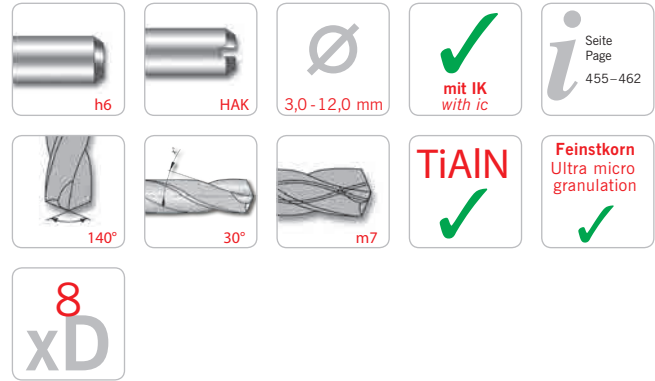

Ausführung 8 x D / Execution 8 x D

Bezeichnung Designation	D m7	d _A h6	l	l ₂	l ₄
SPC0030-0240 VHM/TIALN	3,00	6,00	72,0	34	24,00
SPC0031-0248 VHM/TIALN	3,10	6,00	72,0	34	24,80
SPC0032-0256 VHM/TIALN	3,20	6,00	72,0	34	25,60
SPC0033-0264 VHM/TIALN	3,30	6,00	72,0	34	26,40
SPC0034-0272 VHM/TIALN	3,40	6,00	72,0	34	27,20
SPC0035-0280 VHM/TIALN	3,50	6,00	72,0	34	28,00
SPC0036-0288 VHM/TIALN	3,60	6,00	72,0	34	28,80
SPC0037-0296 VHM/TIALN	3,70	6,00	72,0	34	29,60
SPC0038-0304 VHM/TIALN	3,80	6,00	81,0	43	30,40
SPC0039-0312 VHM/TIALN	3,90	6,00	81,0	43	31,20
SPC0040-0320 VHM/TIALN	4,00	6,00	81,0	43	32,00
SPC0041-0328 VHM/TIALN	4,10	6,00	81,0	43	32,80
SPC0042-0336 VHM/TIALN	4,20	6,00	81,0	43	33,60
SPC0043-0344 VHM/TIALN	4,30	6,00	81,0	43	34,40
SPC0044-0352 VHM/TIALN	4,40	6,00	81,0	43	35,20
SPC0045-0360 VHM/TIALN	4,50	6,00	81,0	43	36,00
SPC0046-0368 VHM/TIALN	4,60	6,00	81,0	43	36,80
SPC0047-0376 VHM/TIALN	4,70	6,00	81,0	43	37,60
SPC0048-0384 VHM/TIALN	4,80	6,00	95,0	57	38,40
SPC0049-0392 VHM/TIALN	4,90	6,00	95,0	57	39,20
SPC0050-0400 VHM/TIALN	5,00	6,00	95,0	57	40,00
SPC0051-0408 VHM/TIALN	5,10	6,00	95,0	57	40,80
SPC0052-0416 VHM/TIALN	5,20	6,00	95,0	57	41,60
SPC0053-0424 VHM/TIALN	5,30	6,00	95,0	57	42,40
SPC0054-0432 VHM/TIALN	5,40	6,00	95,0	57	43,20
SPC0055-0440 VHM/TIALN	5,50	6,00	95,0	57	44,00
SPC0056-0448 VHM/TIALN	5,60	6,00	95,0	57	44,80
SPC0057-0456 VHM/TIALN	5,70	6,00	95,0	57	45,60
SPC0058-0464 VHM/TIALN	5,80	6,00	95,0	57	46,40
SPC0059-0472 VHM/TIALN	5,90	6,00	95,0	57	47,20
SPC0060-0480 VHM/TIALN	6,00	6,00	95,0	57	48,00
SPC0061-0488 VHM/TIALN	6,10	8,00	114,0	76	48,80
SPC0062-0496 VHM/TIALN	6,20	8,00	114,0	76	49,60
SPC0063-0504 VHM/TIALN	6,30	8,00	114,0	76	50,40
SPC0064-0512 VHM/TIALN	6,40	8,00	114,0	76	51,20
SPC0065-0520 VHM/TIALN	6,50	8,00	114,0	76	52,00
SPC0066-0528 VHM/TIALN	6,60	8,00	114,0	76	52,80
SPC0067-0536 VHM/TIALN	6,70	8,00	114,0	76	53,60
SPC0068-0544 VHM/TIALN	6,80	8,00	114,0	76	54,40
SPC0069-0552 VHM/TIALN	6,90	8,00	114,0	76	55,20
SPC0070-0560 VHM/TIALN	7,00	8,00	114,0	76	56,00
SPC0071-0568 VHM/TIALN	7,10	8,00	114,0	76	56,80

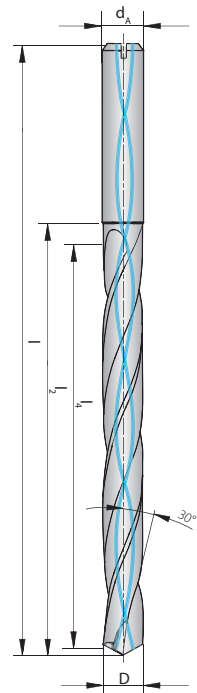

Vollhartmetall-Spiralbohrer

Lange Ausführung, mit Innenkühlung

Solid carbide drills

Long design, with through tool coolant

Ausführung 8 x D / Execution 8 x D

Bezeichnung Designation	D m7	d _A h6	l	l ₂	l ₄
SPC0072-0576 VHM/TIALN	7,20	8,00	114,0	76	57,60
SPC0073-0584 VHM/TIALN	7,30	8,00	114,0	76	58,40
SPC0074-0592 VHM/TIALN	7,40	8,00	114,0	76	59,20
SPC0075-0600 VHM/TIALN	7,50	8,00	114,0	76	60,00
SPC0076-0608 VHM/TIALN	7,60	8,00	114,0	76	60,80
SPC0077-0616 VHM/TIALN	7,70	8,00	114,0	76	61,60
SPC0078-0624 VHM/TIALN	7,80	8,00	114,0	76	62,40
SPC0079-0632 VHM/TIALN	7,90	8,00	114,0	76	63,20
SPC0080-0640 VHM/TIALN	8,00	8,00	114,0	76	64,00
SPC0081-0648 VHM/TIALN	8,10	10,00	142,0	95	64,80
SPC0082-0656 VHM/TIALN	8,20	10,00	142,0	95	65,60
SPC0083-0664 VHM/TIALN	8,30	10,00	142,0	95	66,40
SPC0084-0672 VHM/TIALN	8,40	10,00	142,0	95	67,20
SPC0085-0680 VHM/TIALN	8,50	10,00	142,0	95	68,00
SPC0086-0688 VHM/TIALN	8,60	10,00	142,0	95	68,80
SPC0087-0696 VHM/TIALN	8,70	10,00	142,0	95	69,60
SPC0088-0704 VHM/TIALN	8,80	10,00	142,0	95	70,40
SPC0089-0712 VHM/TIALN	8,90	10,00	142,0	95	71,20
SPC0090-0720 VHM/TIALN	9,00	10,00	142,0	95	72,00
SPC0091-0728 VHM/TIALN	9,10	10,00	142,0	95	72,80
SPC0092-0736 VHM/TIALN	9,20	10,00	142,0	95	73,60
SPC0093-0744 VHM/TIALN	9,30	10,00	142,0	95	74,40
SPC0094-0752 VHM/TIALN	9,40	10,00	142,0	95	75,20
SPC0095-0760 VHM/TIALN	9,50	10,00	142,0	95	76,00
SPC0096-0768 VHM/TIALN	9,60	10,00	142,0	95	76,80
SPC0097-0776 VHM/TIALN	9,70	10,00	142,0	95	77,60
SPC0098-0784 VHM/TIALN	9,80	10,00	142,0	95	78,40
SPC0099-0792 VHM/TIALN	9,90	10,00	142,0	95	79,20
SPC0100-0800 VHM/TIALN	10,00	10,00	142,0	95	80,00
SPC0101-0808 VHM/TIALN	10,10	12,00	162,0	114	80,80
SPC0102-0816 VHM/TIALN	10,20	12,00	162,0	114	81,60
SPC0103-0824 VHM/TIALN	10,30	12,00	162,0	114	82,40
SPC0104-0832 VHM/TIALN	10,40	12,00	162,0	114	83,20
SPC0105-0840 VHM/TIALN	10,50	12,00	162,0	114	84,00
SPC0106-0848 VHM/TIALN	10,60	12,00	162,0	114	84,80
SPC0107-0856 VHM/TIALN	10,70	12,00	162,0	114	85,60
SPC0108-0864 VHM/TIALN	10,80	12,00	162,0	114	86,40
SPC0109-0872 VHM/TIALN	10,90	12,00	162,0	114	87,20
SPC0110-0880 VHM/TIALN	11,00	12,00	162,0	114	88,00
SPC0111-0888 VHM/TIALN	11,10	12,00	162,0	114	88,80
SPC0112-0896 VHM/TIALN	11,20	12,00	162,0	114	89,60
SPC0113-0904 VHM/TIALN	11,30	12,00	162,0	114	90,40
SPC0114-0912 VHM/TIALN	11,40	12,00	162,0	114	91,20
SPC0115-0920 VHM/TIALN	11,50	12,00	162,0	114	92,00
SPC0116-0928 VHM/TIALN	11,60	12,00	162,0	114	92,80
SPC0117-0936 VHM/TIALN	11,70	12,00	162,0	114	93,60
SPC0118-0944 VHM/TIALN	11,80	12,00	162,0	114	94,40
SPC0119-0952 VHM/TIALN	11,90	12,00	162,0	114	95,20
SPC0120-0960 VHM/TIALN	12,00	12,00	162,0	114	96,00

Vollhartmetall-Spiralbohrer

Lange Ausführung, mit Innenkühlung, Diamant beschichtet



Solid carbide drills

Long design, with through tool coolant, diamond coated

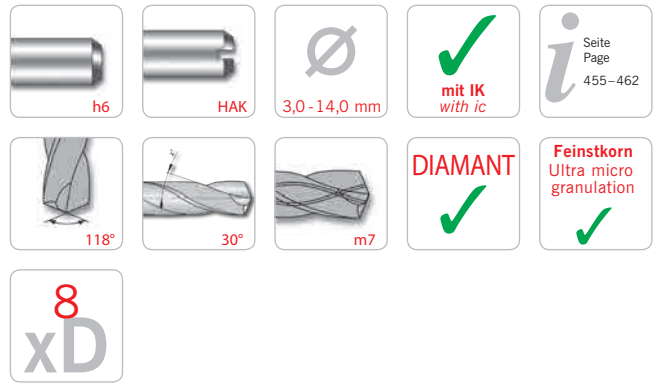

Ausführung 8 x D für Aluminium / Execution 8 x D for aluminium

Bezeichnung Designation	D m7	d _A h6	l	l ₂	l ₄
SPC0030-0240-ALU VHM/DLC	3,00	6,00	72,0	34	24,00
SPC0031-0248-ALU VHM/DLC	3,10	6,00	72,0	34	24,80
SPC0032-0256-ALU VHM/DLC	3,20	6,00	72,0	34	25,60
SPC0033-0264-ALU VHM/DLC	3,30	6,00	72,0	34	26,40
SPC0034-0272-ALU VHM/DLC	3,40	6,00	72,0	34	27,20
SPC0035-0280-ALU VHM/DLC	3,50	6,00	72,0	34	28,00
SPC0036-0288-ALU VHM/DLC	3,60	6,00	72,0	34	28,80
SPC0037-0296-ALU VHM/DLC	3,70	6,00	72,0	34	29,60
SPC0038-0304-ALU VHM/DLC	3,80	6,00	81,0	43	30,40
SPC0039-0312-ALU VHM/DLC	3,90	6,00	81,0	43	31,20
SPC0040-0320-ALU VHM/DLC	4,00	6,00	81,0	43	32,00
SPC0041-0328-ALU VHM/DLC	4,10	6,00	81,0	43	32,80
SPC0042-0336-ALU VHM/DLC	4,20	6,00	81,0	43	33,60
SPC0043-0344-ALU VHM/DLC	4,30	6,00	81,0	43	34,40
SPC0044-0352-ALU VHM/DLC	4,40	6,00	81,0	43	35,20
SPC0045-0360-ALU VHM/DLC	4,50	6,00	81,0	43	36,00
SPC0046-0368-ALU VHM/DLC	4,60	6,00	81,0	43	36,80
SPC0047-0376-ALU VHM/DLC	4,70	6,00	81,0	43	37,60
SPC0048-0384-ALU VHM/DLC	4,80	6,00	95,0	57	38,40
SPC0049-0392-ALU VHM/DLC	4,90	6,00	95,0	57	39,20
SPC0050-0400-ALU VHM/DLC	5,00	6,00	95,0	57	40,00
SPC0051-0408-ALU VHM/DLC	5,10	6,00	95,0	57	40,80
SPC0052-0416-ALU VHM/DLC	5,20	6,00	95,0	57	41,60
SPC0053-0424-ALU VHM/DLC	5,30	6,00	95,0	57	42,40
SPC0054-0432-ALU VHM/DLC	5,40	6,00	95,0	57	43,20
SPC0055-0440-ALU VHM/DLC	5,50	6,00	95,0	57	44,00
SPC0056-0448-ALU VHM/DLC	5,60	6,00	95,0	57	44,80
SPC0057-0456-ALU VHM/DLC	5,70	6,00	95,0	57	45,60
SPC0058-0464-ALU VHM/DLC	5,80	6,00	95,0	57	46,40
SPC0059-0472-ALU VHM/DLC	5,90	6,00	95,0	57	47,20
SPC0060-0480-ALU VHM/DLC	6,00	6,00	95,0	57	48,00
SPC0061-0488-ALU VHM/DLC	6,10	8,00	114,0	76	48,80
SPC0062-0496-ALU VHM/DLC	6,20	8,00	114,0	76	49,60
SPC0063-0504-ALU VHM/DLC	6,30	8,00	114,0	76	50,40
SPC0064-0512-ALU VHM/DLC	6,40	8,00	114,0	76	51,20
SPC0065-0520-ALU VHM/DLC	6,50	8,00	114,0	76	52,00
SPC0066-0528-ALU VHM/DLC	6,60	8,00	114,0	76	52,80
SPC0067-0536-ALU VHM/DLC	6,70	8,00	114,0	76	53,60
SPC0068-0544-ALU VHM/DLC	6,80	8,00	114,0	76	54,40
SPC0069-0552-ALU VHM/DLC	6,90	8,00	114,0	76	55,20
SPC0070-0560-ALU VHM/DLC	7,00	8,00	114,0	76	56,00
SPC0071-0568-ALU VHM/DLC	7,10	8,00	114,0	76	56,80

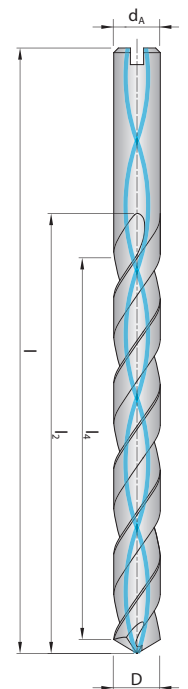

Vollhartmetall-Spiralbohrer

Lange Ausführung, mit Innenkühlung, Diamant beschichtet

Solid carbide drills

Long design, with through tool coolant, diamond coated

Ausführung 8 x D für Aluminium / Execution 8 x D for aluminium

Bezeichnung Designation	D m7	d _A h6	l	l ₂	l ₄
SPC0072-0576-ALU VHM/DLC	7,20	8,00	114,0	76	57,60
SPC0073-0584-ALU VHM/DLC	7,30	8,00	114,0	76	58,40
SPC0074-0592-ALU VHM/DLC	7,40	8,00	114,0	76	59,20
SPC0075-0600-ALU VHM/DLC	7,50	8,00	114,0	76	60,00
SPC0076-0608-ALU VHM/DLC	7,60	8,00	114,0	76	60,80
SPC0077-0616-ALU VHM/DLC	7,70	8,00	114,0	76	61,60
SPC0078-0624-ALU VHM/DLC	7,80	8,00	114,0	76	62,40
SPC0079-0632-ALU VHM/DLC	7,90	8,00	114,0	76	63,20
SPC0080-0640-ALU VHM/DLC	8,00	8,00	114,0	76	64,00
SPC0081-0648-ALU VHM/DLC	8,10	10,00	142,0	95	64,80
SPC0082-0656-ALU VHM/DLC	8,20	10,00	142,0	95	65,60
SPC0083-0664-ALU VHM/DLC	8,30	10,00	142,0	95	66,40
SPC0084-0672-ALU VHM/DLC	8,40	10,00	142,0	95	67,20
SPC0085-0680-ALU VHM/DLC	8,50	10,00	142,0	95	68,00
SPC0086-0688-ALU VHM/DLC	8,60	10,00	142,0	95	68,80
SPC0087-0696-ALU VHM/DLC	8,70	10,00	142,0	95	69,60
SPC0088-0704-ALU VHM/DLC	8,80	10,00	142,0	95	70,40
SPC0089-0712-ALU VHM/DLC	8,90	10,00	142,0	95	71,20
SPC0090-0720-ALU VHM/DLC	9,00	10,00	142,0	95	72,00
SPC0091-0728-ALU VHM/DLC	9,10	10,00	142,0	95	72,80
SPC0092-0736-ALU VHM/DLC	9,20	10,00	142,0	95	73,60
SPC0093-0744-ALU VHM/DLC	9,30	10,00	142,0	95	74,40
SPC0094-0752-ALU VHM/DLC	9,40	10,00	142,0	95	75,20
SPC0095-0760-ALU VHM/DLC	9,50	10,00	142,0	95	76,00
SPC0096-0768-ALU VHM/DLC	9,60	10,00	142,0	95	76,80
SPC0097-0776-ALU VHM/DLC	9,70	10,00	142,0	95	77,60
SPC0098-0784-ALU VHM/DLC	9,80	10,00	142,0	95	78,40
SPC0099-0792-ALU VHM/DLC	9,90	10,00	142,0	95	79,20
SPC0100-0800-ALU VHM/DLC	10,00	10,00	142,0	95	80,00
SPC0101-0808-ALU VHM/DLC	10,10	12,00	162,0	114	80,80
SPC0102-0816-ALU VHM/DLC	10,20	12,00	162,0	114	81,60
SPC0103-0824-ALU VHM/DLC	10,30	12,00	162,0	114	82,40
SPC0104-0832-ALU VHM/DLC	10,40	12,00	162,0	114	83,20
SPC0105-0840-ALU VHM/DLC	10,50	12,00	162,0	114	84,00
SPC0106-0848-ALU VHM/DLC	10,60	12,00	162,0	114	84,80
SPC0107-0856-ALU VHM/DLC	10,70	12,00	162,0	114	85,60
SPC0108-0864-ALU VHM/DLC	10,80	12,00	162,0	114	86,40
SPC0109-0872-ALU VHM/DLC	10,90	12,00	162,0	114	87,20
SPC0110-0880-ALU VHM/DLC	11,00	12,00	162,0	114	88,00
SPC0111-0888-ALU VHM/DLC	11,10	12,00	162,0	114	88,80
SPC0112-0896-ALU VHM/DLC	11,20	12,00	162,0	114	89,60
SPC0113-0904-ALU VHM/DLC	11,30	12,00	162,0	114	90,40
SPC0114-0912-ALU VHM/DLC	11,40	12,00	162,0	114	91,20
SPC0115-0920-ALU VHM/DLC	11,50	12,00	162,0	114	92,00
SPC0116-0928-ALU VHM/DLC	11,60	12,00	162,0	114	92,80
SPC0117-0936-ALU VHM/DLC	11,70	12,00	162,0	114	93,60
SPC0118-0944-ALU VHM/DLC	11,80	12,00	162,0	114	94,40
SPC0119-0952-ALU VHM/DLC	11,90	12,00	162,0	114	95,20
SPC0120-0960-ALU VHM/DLC	12,00	12,00	162,0	114	96,00
SPC0125-1000-ALU VHM/DLC	12,50	14,00	178,0	133	100,00
SPC0130-1040-ALU VHM/DLC	13,00	14,00	178,0	133	104,00
SPC0135-1080-ALU VHM/DLC	13,50	14,00	178,0	133	108,00
SPC0140-1120-ALU VHM/DLC	14,00	14,00	178,0	133	112,00

Vollhartmetall-Spiralbohrer

Lange Ausführung, mit Innenkühlung



Solid carbide drills

Long design, with through tool coolant

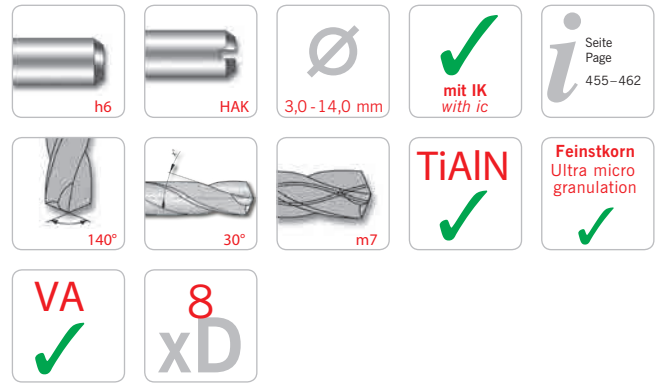

Ausführung 8 x D für rostfreie Stähle / Execution 8 x D for stainless steel

Bezeichnung Designation	D m7	d _A h6	l	l ₂	l ₄
SPC0030-0240-VA VHM/TIALN	3,00	6,00	72,0	34	24,00
SPC0031-0248-VA VHM/TIALN	3,10	6,00	72,0	34	24,80
SPC0032-0256-VA VHM/TIALN	3,20	6,00	72,0	34	25,60
SPC0033-0264-VA VHM/TIALN	3,30	6,00	72,0	34	26,40
SPC0034-0272-VA VHM/TIALN	3,40	6,00	72,0	34	27,20
SPC0035-0280-VA VHM/TIALN	3,50	6,00	72,0	34	28,00
SPC0036-0288-VA VHM/TIALN	3,60	6,00	72,0	34	28,80
SPC0037-0296-VA VHM/TIALN	3,70	6,00	72,0	34	29,60
SPC0038-0304-VA VHM/TIALN	3,80	6,00	81,0	43	30,40
SPC0039-0312-VA VHM/TIALN	3,90	6,00	81,0	43	31,20
SPC0040-0320-VA VHM/TIALN	4,00	6,00	81,0	43	32,00
SPC0041-0328-VA VHM/TIALN	4,10	6,00	81,0	43	32,80
SPC0042-0336-VA VHM/TIALN	4,20	6,00	81,0	43	33,60
SPC0043-0344-VA VHM/TIALN	4,30	6,00	81,0	43	34,40
SPC0044-0352-VA VHM/TIALN	4,40	6,00	81,0	43	35,20
SPC0045-0360-VA VHM/TIALN	4,50	6,00	81,0	43	36,00
SPC0046-0368-VA VHM/TIALN	4,60	6,00	81,0	43	36,80
SPC0047-0376-VA VHM/TIALN	4,70	6,00	81,0	43	37,60
SPC0048-0384-VA VHM/TIALN	4,80	6,00	95,0	57	38,40
SPC0049-0392-VA VHM/TIALN	4,90	6,00	95,0	57	39,20
SPC0050-0400-VA VHM/TIALN	5,00	6,00	95,0	57	40,00
SPC0051-0408-VA VHM/TIALN	5,10	6,00	95,0	57	40,80
SPC0052-0416-VA VHM/TIALN	5,20	6,00	95,0	57	41,60
SPC0053-0424-VA VHM/TIALN	5,30	6,00	95,0	57	42,40
SPC0054-0432-VA VHM/TIALN	5,40	6,00	95,0	57	43,20
SPC0055-0440-VA VHM/TIALN	5,50	6,00	95,0	57	44,00
SPC0056-0448-VA VHM/TIALN	5,60	6,00	95,0	57	44,80
SPC0057-0456-VA VHM/TIALN	5,70	6,00	95,0	57	45,60
SPC0058-0464-VA VHM/TIALN	5,80	6,00	95,0	57	46,40
SPC0059-0472-VA VHM/TIALN	5,90	6,00	95,0	57	47,20
SPC0060-0480-VA VHM/TIALN	6,00	6,00	95,0	57	48,00
SPC0061-0488-VA VHM/TIALN	6,10	8,00	114,0	76	48,80
SPC0062-0496-VA VHM/TIALN	6,20	8,00	114,0	76	49,60
SPC0063-0504-VA VHM/TIALN	6,30	8,00	114,0	76	50,40
SPC0064-0512-VA VHM/TIALN	6,40	8,00	114,0	76	51,20
SPC0065-0520-VA VHM/TIALN	6,50	8,00	114,0	76	52,00
SPC0066-0528-VA VHM/TIALN	6,60	8,00	114,0	76	52,80
SPC0067-0536-VA VHM/TIALN	6,70	8,00	114,0	76	53,60
SPC0068-0544-VA VHM/TIALN	6,80	8,00	114,0	76	54,40
SPC0069-0552-VA VHM/TIALN	6,90	8,00	114,0	76	55,20
SPC0070-0560-VA VHM/TIALN	7,00	8,00	114,0	76	56,00
SPC0071-0568-VA VHM/TIALN	7,10	8,00	114,0	76	56,80

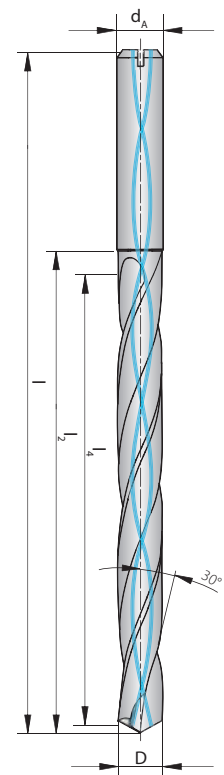

Vollhartmetall-Spiralbohrer

Lange Ausführung, mit Innenkühlung

Solid carbide drills

Long design, with through tool coolant

Ausführung 8 x D für rostfreie Stähle / Execution 8 x D for stainless steel

Bezeichnung Designation	D m7	d _A h6	l	l ₂	l ₄
SPC0072-0576-VA VHM/TIALN	7,20	8,00	114,0	76	57,60
SPC0073-0584-VA VHM/TIALN	7,30	8,00	114,0	76	58,40
SPC0074-0592-VA VHM/TIALN	7,40	8,00	114,0	76	59,20
SPC0075-0600-VA VHM/TIALN	7,50	8,00	114,0	76	60,00
SPC0076-0608-VA VHM/TIALN	7,60	8,00	114,0	76	60,80
SPC0077-0616-VA VHM/TIALN	7,70	8,00	114,0	76	61,60
SPC0078-0624-VA VHM/TIALN	7,80	8,00	114,0	76	62,40
SPC0079-0632-VA VHM/TIALN	7,90	8,00	114,0	76	63,20
SPC0080-0640-VA VHM/TIALN	8,00	8,00	114,0	76	64,00
SPC0081-0648-VA VHM/TIALN	8,10	10,00	142,0	95	64,80
SPC0082-0656-VA VHM/TIALN	8,20	10,00	142,0	95	65,60
SPC0083-0664-VA VHM/TIALN	8,30	10,00	142,0	95	66,40
SPC0084-0672-VA VHM/TIALN	8,40	10,00	142,0	95	67,20
SPC0085-0680-VA VHM/TIALN	8,50	10,00	142,0	95	68,00
SPC0086-0688-VA VHM/TIALN	8,60	10,00	142,0	95	68,80
SPC0087-0696-VA VHM/TIALN	8,70	10,00	142,0	95	69,60
SPC0088-0704-VA VHM/TIALN	8,80	10,00	142,0	95	70,40
SPC0089-0712-VA VHM/TIALN	8,90	10,00	142,0	95	71,20
SPC0090-0720-VA VHM/TIALN	9,00	10,00	142,0	95	72,00
SPC0091-0728-VA VHM/TIALN	9,10	10,00	142,0	95	72,80
SPC0092-0736-VA VHM/TIALN	9,20	10,00	142,0	95	73,60
SPC0093-0744-VA VHM/TIALN	9,30	10,00	142,0	95	74,40
SPC0094-0752-VA VHM/TIALN	9,40	10,00	142,0	95	75,20
SPC0095-0760-VA VHM/TIALN	9,50	10,00	142,0	95	76,00
SPC0096-0768-VA VHM/TIALN	9,60	10,00	142,0	95	76,80
SPC0097-0776-VA VHM/TIALN	9,70	10,00	142,0	95	77,60
SPC0098-0784-VA VHM/TIALN	9,80	10,00	142,0	95	78,40
SPC0099-0792-VA VHM/TIALN	9,90	10,00	142,0	95	79,20
SPC0100-0800-VA VHM/TIALN	10,00	10,00	142,0	95	80,00
SPC0101-0808-VA VHM/TIALN	10,10	12,00	162,0	114	80,80
SPC0102-0816-VA VHM/TIALN	10,20	12,00	162,0	114	81,60
SPC0103-0824-VA VHM/TIALN	10,30	12,00	162,0	114	82,40
SPC0104-0832-VA VHM/TIALN	10,40	12,00	162,0	114	83,20
SPC0105-0840-VA VHM/TIALN	10,50	12,00	162,0	114	84,00
SPC0106-0848-VA VHM/TIALN	10,60	12,00	162,0	114	84,80
SPC0107-0856-VA VHM/TIALN	10,70	12,00	162,0	114	85,60
SPC0108-0864-VA VHM/TIALN	10,80	12,00	162,0	114	86,40
SPC0109-0872-VA VHM/TIALN	10,90	12,00	162,0	114	87,20
SPC0110-0880-VA VHM/TIALN	11,00	12,00	162,0	114	88,00
SPC0111-0888-VA VHM/TIALN	11,10	12,00	162,0	114	88,80
SPC0112-0896-VA VHM/TIALN	11,20	12,00	162,0	114	89,60
SPC0113-0904-VA VHM/TIALN	11,30	12,00	162,0	114	90,40
SPC0114-0912-VA VHM/TIALN	11,40	12,00	162,0	114	91,20
SPC0115-0920-VA VHM/TIALN	11,50	12,00	162,0	114	92,00
SPC0116-0928-VA VHM/TIALN	11,60	12,00	162,0	114	92,80
SPC0117-0936-VA VHM/TIALN	11,70	12,00	162,0	114	93,60
SPC0118-0944-VA VHM/TIALN	11,80	12,00	162,0	114	94,40
SPC0119-0952-VA VHM/TIALN	11,90	12,00	162,0	114	95,20
SPC0120-0960-VA VHM/TIALN	12,00	12,00	162,0	114	96,00
SPC0125-1000-VA VHM/TIALN	12,50	14,00	178,0	133	100,00
SPC0130-1040-VA VHM/TIALN	13,00	14,00	178,0	133	104,00
SPC0135-1080-VA VHM/TIALN	13,50	14,00	178,0	133	108,00
SPC0140-1120-VA VHM/TIALN	14,00	14,00	178,0	133	112,00

Vollhartmetall-Spiralbohrer

Extra lange Ausführung, mit Innenkühlung



Solid carbide drills

Extra long design, with through tool coolant

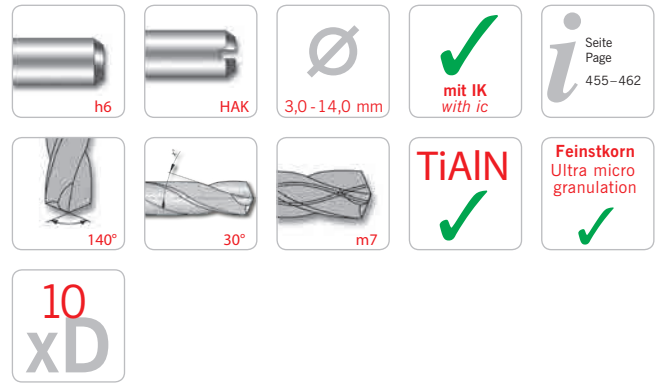

Ausführung 10 x D / Execution 10 x D

Bezeichnung Designation	D m7	d _A h6	l	l ₂	l ₄
SPC0030-0300-XL VHM/TIALN N	3,00	6,00	80,0	40	30,00
SPC0033-0330-XL VHM/TIALN N	3,30	6,00	87,0	47	33,00
SPC0035-0350-XL VHM/TIALN N	3,50	6,00	87,0	47	35,00
SPC0040-0400-XL VHM/TIALN N	4,00	6,00	93,0	53	40,00
SPC0042-0420-XL VHM/TIALN N	4,20	6,00	100,0	60	42,00
SPC0045-0450-XL VHM/TIALN N	4,50	6,00	100,0	60	45,00
SPC0050-0500-XL VHM/TIALN N	5,00	6,00	106,0	66	50,00
SPC0055-0550-XL VHM/TIALN N	5,50	6,00	113,0	73	55,00
SPC0060-0600-XL VHM/TIALN N	6,00	6,00	119,0	79	60,00
SPC0065-0650-XL VHM/TIALN N	6,50	8,00	126,0	86	65,00
SPC0068-0680-XL VHM/TIALN N	6,80	8,00	132,0	92	68,00
SPC0070-0700-XL VHM/TIALN N	7,00	8,00	132,0	92	70,00
SPC0075-0750-XL VHM/TIALN N	7,50	8,00	139,0	99	75,00
SPC0080-0800-XL VHM/TIALN N	8,00	8,00	145,0	105	80,00
SPC0085-0850-XL VHM/TIALN N	8,50	10,00	156,0	112	85,00
SPC0090-0900-XL VHM/TIALN N	9,00	10,00	162,0	118	90,00
SPC0095-0950-XL VHM/TIALN N	9,50	10,00	170,0	126	95,00
SPC0100-1000-XL VHM/TIALN N	10,00	10,00	176,0	132	100,00
SPC0105-1050-XL VHM/TIALN N	10,50	12,00	188,0	139	105,00
SPC0110-1100-XL VHM/TIALN N	11,00	12,00	195,0	145	110,00
SPC0115-1150-XL VHM/TIALN N	11,50	12,00	201,0	152	115,00
SPC0120-1200-XL VHM/TIALN N	12,00	12,00	207,0	158	120,00
SPC0125-1250-XL VHM/TIALN N	12,50	14,00	214,0	165	125,00
SPC0130-1300-XL VHM/TIALN N	13,00	14,00	220,0	171	130,00
SPC0135-1350-XL VHM/TIALN N	13,50	14,00	227,0	178	135,00
SPC0140-1400-XL VHM/TIALN N	14,00	14,00	233,0	184	140,00

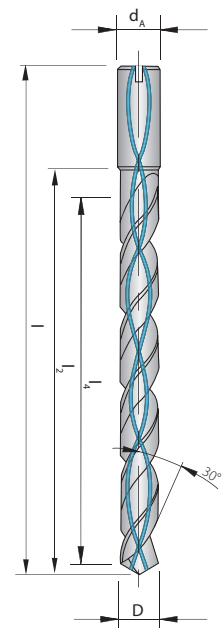

Vollhartmetall-Spiralbohrer

Extra lange Ausführung, mit Innenkühlung



N NEU/NEW

Solid carbide drills

Extra long design, with through tool coolant

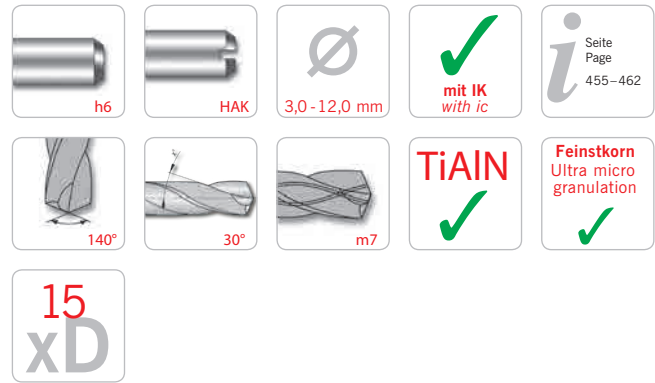

Ausführung 15 x D / Execution 15 x D

Bezeichnung Designation	D m7	d _A h6	l	l ₂	l ₄
SPC0030-0450-XL VHM/TIALN N	3,00	6,00	95,0	55	45,00
SPC0032-0480-XL VHM/TIALN N	3,20	6,00	104,0	64	48,00
SPC0035-0525-XL VHM/TIALN N	3,50	6,00	104,0	64	52,50
SPC0040-0600-XL VHM/TIALN N	4,00	6,00	113,0	73	60,00
SPC0045-0675-XL VHM/TIALN N	4,50	6,00	122,0	82	67,50
SPC0050-0750-XL VHM/TIALN N	5,00	6,00	131,0	91	75,00
SPC0055-0825-XL VHM/TIALN N	5,50	6,00	140,0	100	82,50
SPC0060-0900-XL VHM/TIALN N	6,00	6,00	149,0	109	90,00
SPC0070-1050-XL VHM/TIALN N	7,00	8,00	167,0	127	105,00
SPC0080-1200-XL VHM/TIALN N	8,00	8,00	185,0	145	120,00
SPC0085-1275-XL VHM/TIALN N	8,50	10,00	198,0	154	127,50
SPC0090-1350-XL VHM/TIALN N	9,00	10,00	207,0	163	135,00
SPC0100-1500-XL VHM/TIALN N	10,00	10,00	226,0	182	150,00
SPC0105-1575-XL VHM/TIALN N	10,50	12,00	240,0	191	157,50
SPC0110-1650-XL VHM/TIALN N	11,00	12,00	249,0	200	165,00
SPC0115-1725-XL VHM/TIALN N	11,50	12,00	258,0	209	172,50
SPC0120-1800-XL VHM/TIALN N	12,00	12,00	267,0	218	180,00

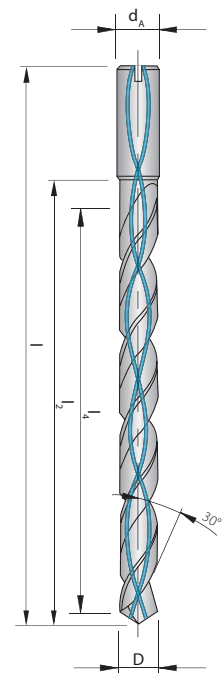

Vollhartmetall-Spiralbohrer

Extra lange Ausführung, mit Innenkühlung



N NEU/NEW

Solid carbide drills

Extra long design, with through tool coolant

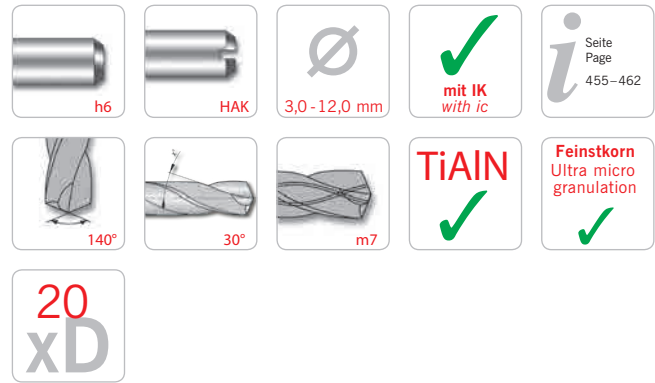

Ausführung 20 x D / Execution 20 x D

Bezeichnung Designation	D m7	d _A h6	l	l ₂	l ₄
SPC0030-0600-XL VHM/TIALN N	3,00	6,00	110,0	70	60,00
SPC0032-0640-XL VHM/TIALN N	3,20	6,00	122,0	82	64,00
SPC0035-0700-XL VHM/TIALN N	3,50	6,00	122,0	82	70,00
SPC0040-0800-XL VHM/TIALN N	4,00	6,00	133,0	93	80,00
SPC0045-0900-XL VHM/TIALN N	4,50	6,00	145,0	105	90,00
SPC0048-0960-XL VHM/TIALN N	4,80	6,00	156,0	116	96,00
SPC0050-1000-XL VHM/TIALN N	5,00	6,00	156,0	116	100,00
SPC0055-1100-XL VHM/TIALN N	5,50	6,00	168,0	128	110,00
SPC0060-1200-XL VHM/TIALN N	6,00	6,00	179,0	139	120,00
SPC0070-1400-XL VHM/TIALN N	7,00	8,00	202,0	162	140,00
SPC0080-1600-XL VHM/TIALN N	8,00	8,00	225,0	185	160,00
SPC0085-1700-XL VHM/TIALN N	8,50	10,00	241,0	197	170,00
SPC0090-1800-XL VHM/TIALN N	9,00	10,00	252,0	208	180,00
SPC0100-2000-XL VHM/TIALN N	10,00	10,00	276,0	232	200,00
SPC0105-2100-XL VHM/TIALN N	10,50	12,00	293,0	244	210,00
SPC0120-2400-XL VHM/TIALN N	12,00	12,00	327,0	278	240,00

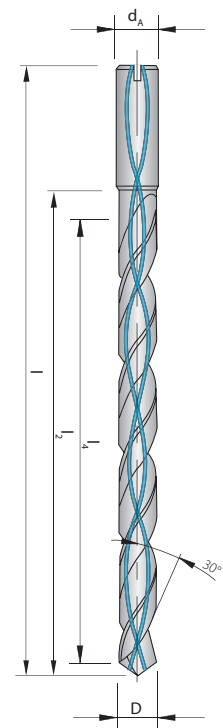

Vollhartmetall-Spiralbohrer

Extra lange Ausführung, mit Innenkühlung



Solid carbide drills

Extra long design, with through tool coolant

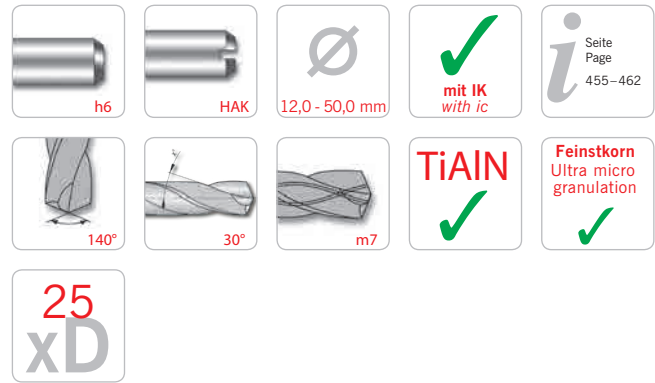

Ausführung 25 x D / Execution 25 x D

Bezeichnung Designation	D m7	d _A h6	l	l ₂	l ₄
SPC0030-0750-XL VHM/TIALN N	3,00	6,00	125,0	85	75,00
SPC0035-0875-XL VHM/TIALN N	3,50	6,00	139,0	99	87,50
SPC0040-1000-XL VHM/TIALN N	4,00	6,00	153,0	113	100,00
SPC0045-1125-XL VHM/TIALN N	4,50	6,00	167,0	127	112,50
SPC0050-1250-XL VHM/TIALN N	5,00	6,00	181,0	141	125,00
SPC0055-1375-XL VHM/TIALN N	5,50	6,00	195,0	155	137,50
SPC0060-1500-XL VHM/TIALN N	6,00	6,00	209,0	169	150,00
SPC0070-1750-XL VHM/TIALN N	7,00	8,00	237,0	197	175,00
SPC0080-2000-XL VHM/TIALN N	8,00	8,00	265,0	225	200,00
SPC0085-2125-XL VHM/TIALN N	8,50	10,00	283,0	239	212,50
SPC0090-2250-XL VHM/TIALN N	9,00	10,00	297,0	253	225,00
SPC0100-2500-XL VHM/TIALN N	10,00	10,00	326,0	282	250,00

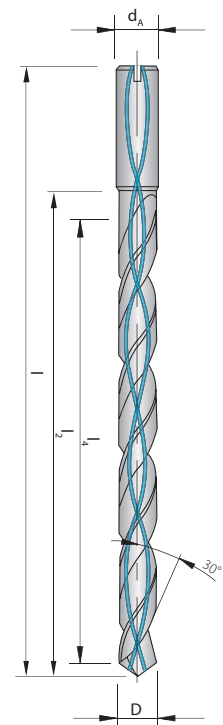

Vollhartmetall-Spiralbohrer

Extra lange Ausführung, mit Innenkühlung



Solid carbide drills

Extra long design, with through tool coolant

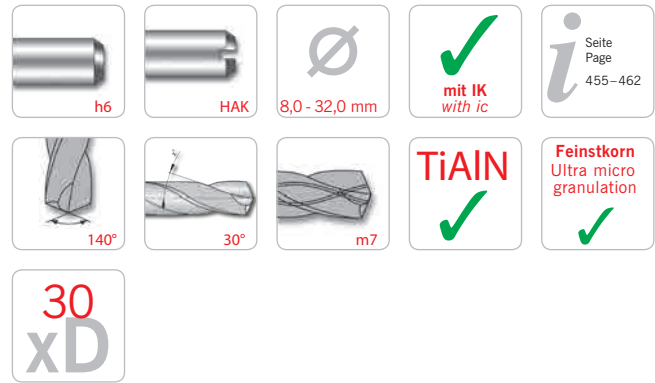

Ausführung 30 x D / Execution 30 x D

Bezeichnung Designation	D m7	d _A h6	l	l ₂	l ₄
SPC0030-0900-XL VHM/TIALN N	3,00	6,00	140,0	100	90,00
SPC0035-1050-XL VHM/TIALN N	3,50	6,00	157,0	117	105,00
SPC0040-1200-XL VHM/TIALN N	4,00	6,00	173,0	133	120,00
SPC0045-1350-XL VHM/TIALN N	4,50	6,00	190,0	150	135,00
SPC0050-1500-XL VHM/TIALN N	5,00	6,00	206,0	166	150,00
SPC0055-1650-XL VHM/TIALN N	5,50	6,00	223,0	183	165,00
SPC0060-1800-XL VHM/TIALN N	6,00	6,00	239,0	199	180,00
SPC0070-2100-XL VHM/TIALN N	7,00	8,00	272,0	232	210,00
SPC0080-2400-XL VHM/TIALN N	8,00	8,00	305,0	265	240,00

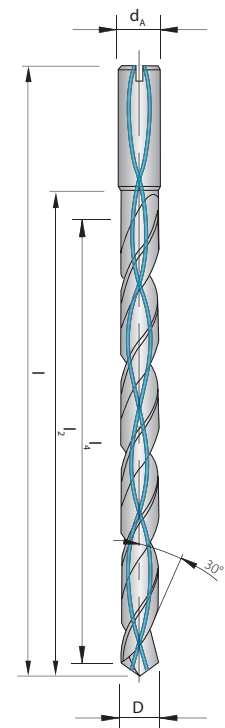

Vollhartmetall NC-Anbohrer

2 Schneiden, 90°



Solid carbide NC spot drills

2 flutes, 90°

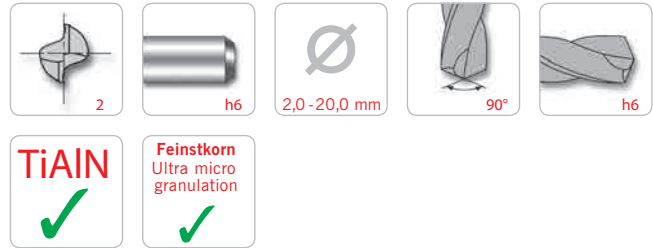

NC – Anbohrer 90° / NC spot drill 90°

Bezeichnung Designation	D m7	d _A h6	l	l ₂
SPA0020-090 VHM/TIALN	2,00	2,00	40,0	8
SPA0030-090 VHM/TIALN	3,00	3,00	40,0	10
SPA0040-090 VHM/TIALN	4,00	4,00	40,0	12
SPA0050-090 VHM/TIALN	5,00	5,00	50,0	15
SPA0060-090 VHM/TIALN	6,00	6,00	50,0	20
SPA0080-090 VHM/TIALN	8,00	8,00	63,0	22
SPA0100-090 VHM/TIALN	10,00	10,00	74,0	23
SPA0120-090 VHM/TIALN	12,00	12,00	83,0	25
SPA0140-090 VHM/TIALN	14,00	14,00	83,0	26
SPA0160-090 VHM/TIALN	16,00	16,00	92,0	28
SPA0180-090 VHM/TIALN	18,00	18,00	92,0	30
SPA0200-090 VHM/TIALN	20,00	20,00	104,0	30

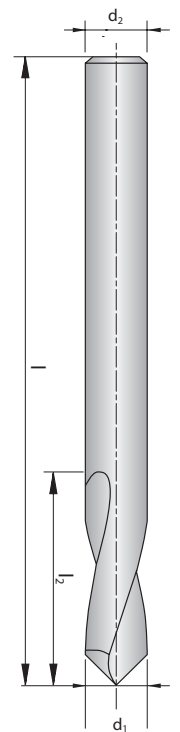

Vollhartmetall NC-Anbohrer

2 Schneiden, 120°



Solid carbide NC spot drills

2 flutes, 120°



NC - Anbohrer 120° / NC spot drill 120°

Bezeichnung Designation	D m7	d _A h6	l	l ₂
SPA0020-120 VHM/TIALN	2,00	2,00	40,0	8
SPA0030-120 VHM/TIALN	3,00	3,00	40,0	10
SPA0040-120 VHM/TIALN	4,00	4,00	40,0	12
SPA0050-120 VHM/TIALN	5,00	5,00	50,0	15
SPA0060-120 VHM/TIALN	6,00	6,00	50,0	20
SPA0080-120 VHM/TIALN	8,00	8,00	63,0	22
SPA0100-120 VHM/TIALN	10,00	10,00	74,0	23
SPA0120-120 VHM/TIALN	12,00	12,00	83,0	25
SPA0140-120 VHM/TIALN	14,00	14,00	83,0	26
SPA0160-120 VHM/TIALN	16,00	16,00	92,0	28
SPA0180-120 VHM/TIALN	18,00	18,00	92,0	30
SPA0200-120 VHM/TIALN	20,00	20,00	104,0	30

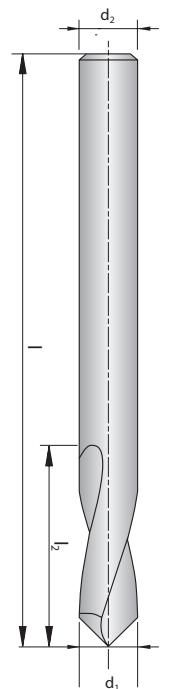

Vollhartmetall NC-Anbohrer

2 Schneiden, 135°



Solid carbide NC spot drills

2 flutes, 135°

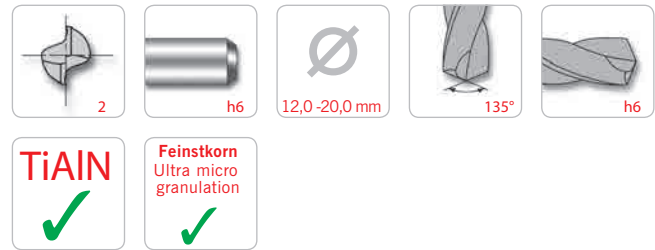

NC - Anbohrer 135° / NC spot drill 135°

Bezeichnung Designation	D m7	d _A h6	l	l ₂
SPA0120-135 VHM/TIALN N	12,00	12,00	83,0	25
SPA0160-135 VHM/TIALN N	16,00	16,00	92,0	28
SPA0200-135 VHM/TIALN N	20,00	20,00	104,0	30

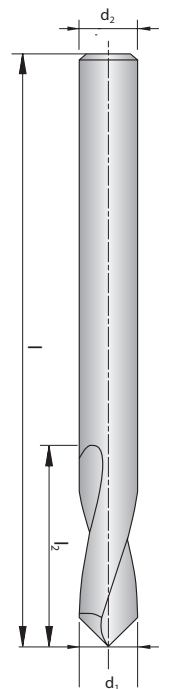

PM-HSS NC-Anbohrer

2 Schneiden, 90°



Powder metal NC spot drills

2 flutes, 90°

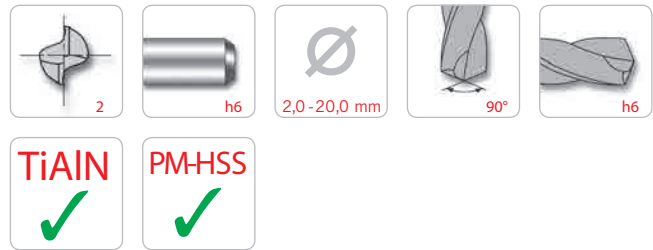

NC - Anbohrer 90° / NC spot drill 90°

Bezeichnung Designation	D m7	d _A h6	l	l ₂
SPA0020-090-PM TIALN	2,00	2,00	40,0	8
SPA0030-090-PM TIALN	3,00	3,00	40,0	10
SPA0040-090-PM TIALN	4,00	4,00	40,0	12
SPA0050-090-PM TIALN	5,00	5,00	50,0	15
SPA0060-090-PM TIALN	6,00	6,00	50,0	20
SPA0080-090-PM TIALN	8,00	8,00	63,0	22
SPA0100-090-PM TIALN	10,00	10,00	74,0	23
SPA0120-090-PM TIALN	12,00	12,00	83,0	25
SPA0140-090-PM TIALN	14,00	14,00	83,0	26
SPA0160-090-PM TIALN	16,00	16,00	92,0	28
SPA0180-090-PM TIALN	18,00	18,00	92,0	30
SPA0200-090-PM TIALN	20,00	20,00	104,0	30

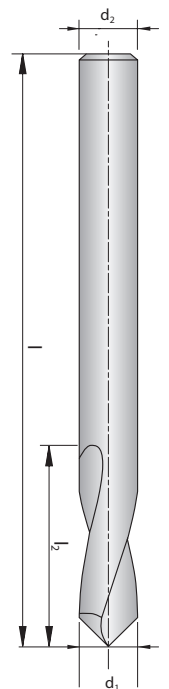

PM-HSS NC-Anbohrer

2 Schneiden, 120°



Powder metal NC spot drills

2 flutes, 120°

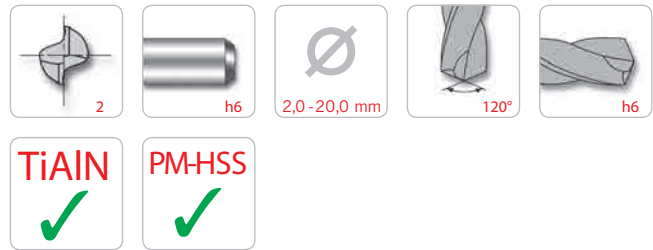

NC - Anbohrer 120° / NC spot drill 120°

Bezeichnung Designation	D m7	d _A h6	l	l ₂
SPA0020-120-PM TIALN	2,00	2,00	40,0	8
SPA0030-120-PM TIALN	3,00	3,00	40,0	10
SPA0040-120-PM TIALN	4,00	4,00	40,0	12
SPA0050-120-PM TIALN	5,00	5,00	50,0	15
SPA0060-120-PM TIALN	6,00	6,00	50,0	20
SPA0080-120-PM TIALN	8,00	8,00	63,0	22
SPA0100-120-PM TIALN	10,00	10,00	74,0	23
SPA0120-120-PM TIALN	12,00	12,00	83,0	25
SPA0140-120-PM TIALN	14,00	14,00	83,0	26
SPA0160-120-PM TIALN	16,00	16,00	92,0	28
SPA0180-120-PM TIALN	18,00	18,00	92,0	30
SPA0200-120-PM TIALN	20,00	20,00	104,0	30

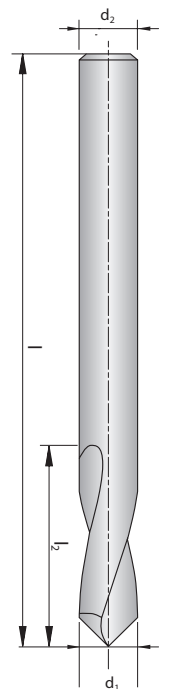

PM-HSS NC-Anbohrer

2 Schneiden, 135°



Powder metal NC spot drills

2 flutes, 135°



NC - Anbohrer 135° / NC spot drill 135°

Bezeichnung Designation	D m7	d _A h6	l	l ₂
SPA0120-135-PM TiAlN	12,00	12,00	83,0	25
SPA0160-135-PM TiAlN	16,00	16,00	92,0	28
SPA0200-135-PM TiAlN	20,00	20,00	104,0	30

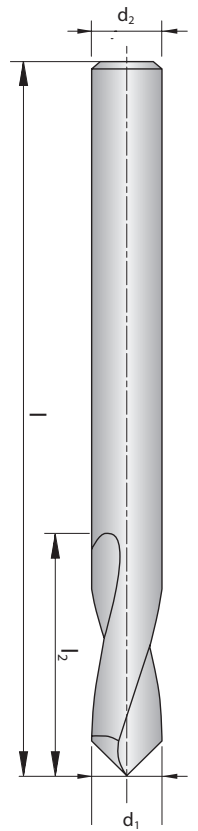

Vollhartmetall Zentrierer

Solid carbide centre drills

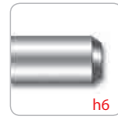
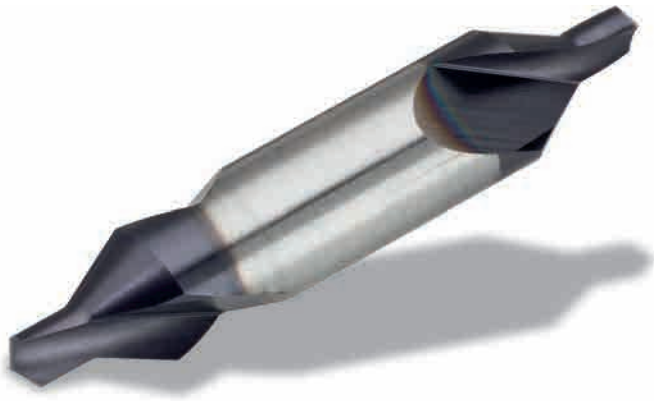

Zentrierbohrer DIN 333, Form A / Centre drills DIN 333, Form A

Bezeichnung Designation	D m7	d _A h6	l	l ₂
SPZ0100-0016 VHM/TIALN	1,00	3,15	31,5	1,6
SPZ0125-0019 VHM/TIALN	1,25	3,15	31,5	1,9
SPZ0160-0024 VHM/TIALN	1,60	4,00	35,5	2,4
SPZ0200-0029 VHM/TIALN	2,00	5,00	40,0	2,9
SPZ0250-0036 VHM/TIALN	2,50	6,30	45,0	3,6
SPZ0315-0044 VHM/TIALN	3,15	8,00	50,0	4,4
SPZ0400-0056 VHM/TIALN	4,00	10,00	56,0	5,6
SPZ0500-0069 VHM/TIALN	5,00	12,50	63,0	6,9
SPZ0630-0086 VHM/TIALN	6,30	16,00	71,0	8,6

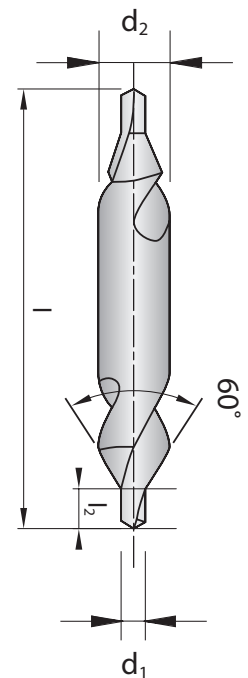

PM-HSS Zentrierer

Powder metal centre drills

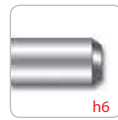

Zentrierbohrer DIN 333, Form A / Centre drills DIN 333, Form A

Bezeichnung Designation	D m7	d _A h6	l	l ₂
SPZ0100-0016-PM TIALN	1,00	3,15	31,5	1,6
SPZ0125-0019-PM TIALN	1,25	3,15	31,5	1,9
SPZ0160-0024-PM TIALN	1,60	4,00	35,5	2,4
SPZ0200-0029-PM TIALN	2,00	5,00	40,0	2,9
SPZ0250-0036-PM TIALN	2,50	6,30	45,0	3,6
SPZ0315-0044-PM TIALN	3,15	8,00	50,0	4,4
SPZ0400-0056-PM TIALN	4,00	10,00	56,0	5,6
SPZ0500-0069-PM TIALN	5,00	12,50	63,0	6,9
SPZ0630-0086-PM TIALN	6,30	16,00	71,0	8,6

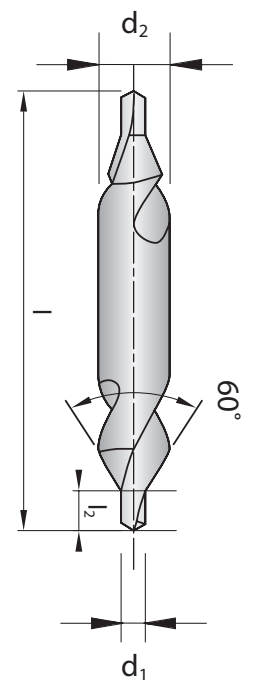

Vollhartmetall-Spiralbohrer

Empfohlene Schnittwerte

Solid carbide drills

Application reference



Vollhartmetall-Bohrer TiAlN-beschichtet (ohne Innenkühlung)

Solid carbide drills TiAlN coated (without internal coolant)

Werkstoff / Material	Zugfestigkeit Tensile strength [N/mm ²]	V _c [m/min] V _c [m/rev]	Durchmesser / Diameter [mm]							
			1 ~ 3 f [mm/U]	3 ~ 5 f [mm/U]	5 ~ 8 f [mm/U]	8 ~ 10 f [mm/U]	10 ~ 12 f [mm/U]	12 ~ 14 f [mm/U]	14 ~ 20 f [mm/U]	
Kupfer und Kupferlegierungen (Bronze / Messing) Copper and copper alloys (brass / bronze)	–	60–170	0,02–0,16	0,06–0,18	0,10–0,20	0,18–0,30	0,25–0,35	0,30–0,38	0,30–0,50	
Aluminium hoher Si-Gehalt Aluminium - high Si-content	–	60–179	0,05–0,10	0,10–0,20	0,15–0,30	0,20–0,30	0,25–0,35	0,25–0,35	0,30–0,50	
Aluminium niedriger Si-Gehalt Aluminium - low Si-content	–	70–260	0,05–0,10	0,10–0,20	0,15–0,30	0,20–0,30	0,25–0,35	0,25–0,35	0,30–0,50	
Titanlegierungen Titanium alloys	–	13–32	0,01–0,04	0,03–0,07	0,06–0,12	0,06–0,12	0,08–0,15	0,08–0,15	0,10–0,16	
Hochtemperaturlegierungen High Temperature alloys	> 1000	13–27	0,02–0,06	0,03–0,07	0,04–0,08	0,06–0,10	0,08–0,14	0,08–0,14	0,08–0,16	
Nickellegierungen Nickel alloys	> 1000	13–27	–	–	–	–	–	–	–	
„Superlegierungen“ z.B. Inconel Hasteloy Nimonic Super Alloys e.g. Inconel, Hasteloy, Nimonic	> 1000	13–27	–	–	–	–	–	–	–	
Unlegierter Stahl und Stahlguss Unalloyed steel and cast steel	bis / up to 600	80–102	0,05–0,10	0,10–0,18	0,15–0,25	0,20–0,30	0,20–0,30	0,20–0,35	0,25–0,40	
Unlegierter Stahl und Stahlguss Unalloyed steel and cast steel	600–900	68–85	0,01–0,10	0,08–0,18	0,15–0,25	0,20–0,30	0,20–0,30	0,20–0,35	0,25–0,40	
	450–900	55–77	0,05–0,15	0,10–0,20	0,15–0,25	0,18–0,35	0,18–0,35	0,20–0,35	0,25–0,42	
Nieder- und hochlegierte Stähle und Stahlguss Low and high alloyed steels and cast steel	900–1000	43–60	0,06–0,12	0,08–0,15	0,10–0,18	0,15–0,25	0,15–0,25	0,16–0,30	0,20–0,32	
	über / over 1000	37–50	0,06–0,12	0,08–0,15	0,10–0,18	0,15–0,25	0,15–0,25	0,16–0,30	0,20–0,32	
Rostfreie Stähle Stainless steels	500–700	38–50	0,02–0,08	0,04–0,10	0,06–0,12	0,10–0,20	0,10–0,20	0,10–0,20	0,12–0,25	
Rostfreie Stähle Stainless steels	700–1000	30–43	0,02–0,08	0,04–0,10	0,06–0,12	0,10–0,20	0,10–0,20	0,10–0,20	0,12–0,25	
Gusseisen, Temperguss Cast iron, malleable cast iron	bis / up to 700	77–110	0,10–0,15	0,12–0,16	0,15–0,33	0,25–0,45	0,25–0,45	0,30–0,50	0,35–0,55	
	850–1000	60–72	0,08–0,15	0,10–0,16	0,12–0,30	0,20–0,40	0,20–0,40	0,25–0,40	0,30–0,45	
Hartguss Hard cast iron	1170 – 1500	35–55	0,06–0,10	0,08–0,12	0,08–0,12	0,10–0,14	0,10–0,14	0,12–0,16	0,14–0,18	

Achtung:

Bei unbeschichteten Spiralbohrern die Schnittgeschwindigkeiten um ca. 30% reduzieren.

Attention:

Reduce the cutting speed by approximately 30% when using the uncoated drills.

Achtung:

Die obigen Empfehlungen gelten für Bohrer bis Bohrtiefe 3 x D. Bitte reduzieren Sie den Vorschub bei 5 x D um den Faktor 0,85.

Attention:

Cutting Data refer to solid carbide drills 3 x D. For using 5 x D please reduce the feed rate by factor 0,85.

Alle Angaben in mm / Dimensions in mm

Vollhartmetall-Spiralbohrer

Empfohlene Schnittwerte

Solid carbide drills

Application reference



Vollhartmetall-Bohrer mit Kühlkanal DIN6537, TiAlN-beschichtet

Solid carbide drills with coolant DIN6537, TiAlN coated

Werkstoff / Material	Zugfestigkeit Tensile strength [N/mm ²]	V _c [m/min] V _c [m/rev]	Durchmesser / Diameter [mm]						
			1 ~ 3 f [mm/U]	3 ~ 5 f [mm/U]	5 ~ 8 f [mm/U]	8 ~ 10 f [mm/U]	10 ~ 12 f [mm/U]	12 ~ 14 f [mm/U]	14 ~ 20 f [mm/U]
Kupfer und Kupferlegierungen (Bronze / Messing) Copper and copper alloys (brass / bronze)	-	70-200	0,02-0,16	0,06-0,18	0,10-0,20	0,18-0,30	0,25-0,35	0,30-0,38	0,30-0,50
Aluminium hoher Si-Gehalt Aluminium - high Si-content	-	70-210	0,05-0,10	0,10-0,20	0,15-0,30	0,20-0,30	0,20-0,35	0,25-0,35	0,30-0,50
Aluminium niedriger Si-Gehalt Aluminium - low Si-content	-	80-305	0,05-0,10	0,10-0,20	0,15-0,30	0,20-0,30	0,20-0,35	0,25-0,35	0,30-0,50
Titanlegierungen Titanium alloys	-	15-38	0,01-0,04	0,03-0,07	0,06-0,12	0,06-0,12	0,08-0,15	0,08-0,15	0,10-0,16
Hochtemperaturlegierungen High Temperature alloys	> 1000	15-32	0,02-0,06	0,03-0,07	0,04-0,08	0,06-0,10	0,08-0,12	0,08-0,14	0,08-0,16
Nickellegierungen Nickel alloys	> 1000	15-32	-	-	-	-	-	-	-
„Superlegierungen“ z.B. Inconel Hasteloy Nimonic Super Alloys e.g. Inconel, Hasteloy, Nimonic	> 1000	15-32	-	-	-	-	-	-	-
Unlegierter Stahl und Stahlguss Unalloyed steel and cast steel	bis / up to 600	100-120	0,05-0,10	0,10-0,18	0,15-0,25	0,18-0,28	0,20-0,30	0,20-0,35	0,25-0,40
Unlegierter Stahl und Stahlguss Unalloyed steel and cast steel	600-900	80-100	0,05-0,10	0,08-0,18	0,15-0,25	0,18-0,28	0,20-0,30	0,20-0,35	0,25-0,40
	450-900	65-90	0,05-0,15	0,10-0,20	0,15-0,25	0,18-0,30	0,18-0,35	0,20-0,35	0,25-0,42
Nieder- und hochlegierte Stähle und Stahlguss Low and high alloyed steels and cast steel	900-1000	50-70	0,06-0,12	0,08-0,15	0,10-0,18	0,12-0,20	0,15-0,25	0,16-0,30	0,20-0,32
	über / over 1000	43-60	0,06-0,12	0,08-0,15	0,10-0,18	0,12-0,20	0,15-0,25	0,16-0,30	0,20-0,32
Rostfreie Stähle Stainless steels	500-700	45-60	0,02-0,08	0,04-0,10	0,06-0,12	0,10-0,18	0,10-0,20	0,10-0,20	0,12-0,25
Rostfreie Stähle Stainless steels	700-1000	35-50	0,02-0,08	0,04-0,10	0,06-0,12	0,10-0,18	0,10-0,20	0,10-0,20	0,12-0,25
Gusseisen, Temperguss Cast iron, malleable cast iron	bis / up to 700	90-130	0,08-0,10	0,12-0,16	0,15-0,33	0,20-0,40	0,25-0,45	0,30-0,50	0,35-0,55
	850-1000	70-85	0,08-0,10	0,10-0,16	0,12-0,30	0,20-0,35	0,20-0,40	0,25-0,40	0,30-0,45
Hartguss Hard cast iron	1170 - 1500	40-65	0,04-0,08	0,06-0,10	0,08-0,12	0,10-0,14	0,10-0,14	0,12-0,16	0,14-0,18

Achtung:

Die obigen Empfehlungen gelten für Bohrer bis Bohrtiefe 3 x D.
Bitte reduzieren Sie den Vorschub bei 5 x D oder 8 x D um den Faktor: 5 x D: 0,85 und 8 x D: 0,70

Attention:

Cutting Data refer to solid carbide drills 3 x D.
For using 5 x D or 8 x D please reduce the feed rate by following factor: 5 x D: 0,85 and 8 x D: 0,70.

PM-HSS-Spiralbohrer

Empfohlene Schnittwerte

Powder metal drills drills

Application reference



PM-HSS Spiralbohrer (ohne Innenkühlung) Powder metal drills (without internal coolant)

Werkstoff / Material	Vc [m/min] Vc [m/rev]	Durchmesser / Diameter [mm]									
		1 f [mm/U]	2 f [mm/U]	3 f [mm/U]	4 f [mm/U]	5 f [mm/U]	6 f [mm/U]	8 f [mm/U]	10 f [mm/U]	12 f [mm/U]	
Baustahl, Kohlenstoffstahl, Automatenstahl Structural steels, Carbon steels, Free machining steels	30-50	0,02	0,06	0,12	0,15	0,16	0,20	0,24	0,27	0,29	
Legierter Stahl, Naturharter Stahl Alloy steels, pre-hardened steels	25-32	0,02	0,05	0,09	0,13	0,16	0,18	0,20	0,24	0,26	
Werkzeugstahl, Rostfreier Stahl, gehärteter Stahl 30-45 HRC Tool steels, Stainless steel, Hardened steels HRC 30-45	10-16	0,02	0,05	0,09	0,10	0,11	0,14	0,17	0,21	0,23	
Gusseisen Cast iron	35-55	0,03	0,08	0,14	0,18	0,21	0,25	0,29	0,32	0,36	
Aluminiumlegierungen, Nichteisenlegierungen Aluminum alloys, non-ferrous alloys	50-70	0,04	0,09	0,15	0,18	0,22	0,25	0,30	0,33	0,35	
Hochtemperaturlegierungen, Superlegierungen (Nimonic, Hasteloy, Inconell ...) High temperature alloys, superalloys (Nimonic, Hasteloy, Inconell ...)	3-8	0,01	0,02	0,03	0,04	0,05	0,06	0,08	0,10	0,12	
Titan, Titanlegierungen Titanium, titanium alloys	3-8	0,01	0,02	0,03	0,04	0,05	0,06	0,08	0,10	0,12	
Hardox (Hardox 400/500) Hardox (Hardox 400/500)	4-6	-	-	-	-	-	0,06	0,07	0,08	0,10	

Empfohlenes Kühlmittel Recommended coolant

Werkstoff / Material	Empfohlenes Kühlmittel / Recommended coolant
Baustahl, Kohlenstoffstahl / Structural steel, Carbon steel	Emulsion (ca. 7 - 8%) / Emulsion (approx. 7 - 8%)
Legierter Stahl, Stahlguss / Alloy steel, Cast steel	Emulsion (ca. 7 - 8%) oder [Öl] / Emulsion (approx. 7 - 8%) or [oil]
Rostfreier Stahl, Federstahl / Stainless steel, Spring steel	Öl oder (Emulsion ca. 10 - 12%) / Oil or (Emulsion approx. 10 - 12%)

Vollhartmetall-Spiralbohrer

Solid carbide drills

Empfohlene Schnittwerte 10xD / 15xD / 20xD / 25xD / 30xD

Application reference 10xD / 15xD / 20xD / 25xD / 30xD

Vollhartmetall-Bohrer mit Kühlkanal DIN6537, TiAlN-beschichtet

Solid carbide drills with coolant DIN6537, TiAlN coated



Material		Durchmesser / Diameter [mm]				
		3 ~ 5	5 ~ 8	8 ~ 12	12 ~ 16	
		Vc [m/min]	f [mm/U]	f [mm/U]	f [mm/U]	f [mm/U]
Automatenstahl Free cutting steel	bis / up to 500 N/mm ²	90-110	0,14	0,20	0,275	0,35
	über / above 500 N/mm ²	75-100	0,10	0,15	0,200	0,26
Baustahl Construction steel	unlegiert bis / unalloyed up to 500 N/mm ²	90-110	0,14	0,20	0,275	0,35
	unlegiert über / unalloyed above 500 N/mm ²	75-100	0,10	0,15	0,200	0,26
	legiert / alloyed	70-95	0,10	0,15	0,200	0,26
Federstahl Spring steel	geglüht / annealed (up to 250 HB)	-	-	-	-	-
	naturhart / nature hard (250 - 350 HB)	-	-	-	-	-
	federhart / cold-hammered (1200 - 1600 N/mm ²)	-	-	-	-	-
Einsatzstahl Hardened steel	bis / up to 150 HB	80-105	0,14	0,20	0,275	0,35
	150-200 HB	75-100	0,14	0,15	0,275	0,35
	über / above 200 HB	70-95	0,10	0,15	0,200	0,26
Nitrierstahl Nitriding steel	bis / up to 1000 N/mm ²	70-95	0,1	0,15	0,2	0,26
	über / above 1000 N/mm ²	70-95	0,1	0,15	0,2	0,26
Vergütungsstahl Tempering steel	unlegiert bis / unalloyed up to 800 N/mm ²	75-95	0,14	0,20	0,275	0,35
	unlegiert / unalloyed - 800-1000 N/mm ²	70-95	0,10	0,15	0,200	0,26
	legiert bis / alloyed up to 800 N/mm ²	70-95	0,14	0,20	0,275	0,35
	legiert / alloyed 800-1000 N/mm ²	70-95	0,10	0,15	0,200	0,26
	legiert / alloyed 1000-1300 N/mm ²	55-75	0,10	0,15	0,200	0,26
	legiert / alloyed 1300-1600 N/mm ²	-	-	-	-	-
Werkzeugstahl unlegiert Unalloyed tool steel	allgemein / general	55-75	0,1	0,15	0,2	0,26
Werkzeugstahl für Kaltarbeit Tool steel for cold application	niedrig legiert bis / low alloy up to 1000 N/mm ²	70-95	0,1	0,15	0,2	0,26
	niedrig legiert bis / low alloy up to 1200 N/mm ²	55-75	0,1	0,15	0,2	0,26
	niedrig legiert bis / low alloy up to 1500 N/mm ²	-	-	-	-	-
	hoch legiert-geglüht bis / high alloy-annealed up to 1000 N/mm ²	-	-	-	-	-
	hoch legiert-vergütet bis / high alloy-tempered up to 1300 N/mm ²	-	-	-	-	-
Werkzeugstahl für Warmarbeit Tool steel for warm application	niedrig legiert bis / low alloy up to 1200 N/mm ²	-	-	-	-	-
	niedrig legiert bis / low alloy up to 1500 N/mm ²	-	-	-	-	-
	hoch legiert-geglüht bis / high alloy-annealed up to 1000 N/mm ²	55-75	0,1	0,15	0,2	0,26
	hoch legiert-vergütet bis / high alloy-tempered up to 1300 N/mm ²	-	-	-	-	-
	hoch legiert-vergütet bis / high alloy-tempered up to 1600 N/mm ²	-	-	-	-	-
Gehärteter Werkzeugstahl Hardened tool steel	55-70 HRC	-	-	-	-	-
Rostfreier Stahl Stainless steel	ferritisch / ferritic	70-75	0,08	0,12	0,15	0,2
	martensitisch / martensitic	45-60	0,08	0,12	0,15	0,2
	austenitisch / austenitic < 40%	50-65	0,08	0,12	0,15	0,2
	austenitisch / austenitic > 40%	50-65	0,08	0,12	0,15	0,2
	geschwefelt / sulfated	70-75	0,08	0,12	0,15	0,2
Hochwarmfeste Legierungen High-temperature alloy	Fe / Ni / Co-Legierungen / alloys	-	-	-	-	-
Konventioneller Stahlguss Conventional steel casting	unlegiert / unalloyed	75-100	0,14	0,20	0,275	0,35
	niedrig legiert / low alloy	70-95	0,10	0,15	0,200	0,26
	hoch legiert / high alloy	55-75	0,10	0,15	0,200	0,26
Rostfreier Stahlguss Stainless steel casting	ferritisch/martensitisch / ferritic/martensitic	45-65	0,08	0,12	0,15	0,2
	austenitisch / austenitic	50-60	0,08	0,12	0,15	0,2
Grauguss (mit Lamellen-Graphit) Cast iron (with lamella graphite)	unlegiert bis / unalloyed up to 180 HB	85-105	0,23	0,335	0,425	0,52
	unlegiert über / unalloyed above 180 HB	75-100	0,23	0,335	0,425	0,52
	unlegiert / unalloyed	70-95	0,23	0,335	0,425	0,52
	hoch legiert / high alloy	65-75	0,08	0,120	0,150	0,20
Grauguss (mit Kugelgraphit) Cast iron (with spheroidale graphite)	unlegiert bis / unalloyed up to 180 HB	80-105	0,20	0,250	0,35	0,400
	unlegiert über / unalloyed above 180 HB	75-100	0,20	0,250	0,35	0,400
	legiert / alloyed	55-75	0,11	0,125	0,15	0,175
GTW (weißer Temperguss) GTW (white malleable cast iron)	bis / up to 180 HB	80-105	0,2	0,25	0,35	0,4
	über / above 180 HB	75-100	0,2	0,25	0,35	0,4
GTS (schwarzer Temperguss) GTS (black malleable cast iron)	bis / up to 180 HB	80-105	0,2	0,25	0,35	0,4
	über / above 180 HB	75-100	0,2	0,25	0,35	0,4
NE-Metalle Non-ferrous metal	Aluminium	-	-	-	-	-
	Magnesium	-	-	-	-	-
	Kupfer / Copper	-	-	-	-	-
	Messing / Brass (CuZn)	-	-	-	-	-
	Bronze (CuSn)	-	-	-	-	-
Thermoplast / Duroplast		-	-	-	-	-
Faserverstärkter Kunststoff Fibre-reinforced plastic		-	-	-	-	-
Graphit / Graphite		-	-	-	-	-

Vollhartmetall-Spiralbohrer

Empfohlene Schnittwerte für Aluminium

Solid carbide drills

Recommended cutting data for aluminium



3 x D und 5 x D – VHM-Spiralbohrer – Diamant beschichtet (mit Innenkühlung)

3 x D und 5 x D – Solid carbide drills – diamond coated (with internal coolant)

Werkstoff / Material	Härte / Hardness		V _c [m/min] V _c [m/rev]	Durchmesser / Diameter [mm]								
				3 f [mm/U]	4 f [mm/U]	5 f [mm/U]	6 f [mm/U]	8 f [mm/U]	10 f [mm/U]	12 f [mm/U]	16 f [mm/U]	20 f [mm/U]
Aluminium und Al-Legierungen Aluminium and AL alloys	< 400 N/mm ²	Öl/Emulsion	260	0,160	0,200	0,250	0,315	0,315	0,400	0,500	0,630	0,630
Aluminium-Knetlegierungen Aluminium alloys – long chipping	< 450 N/mm ²	Öl/Emulsion	260	0,160	0,200	0,250	0,315	0,315	0,400	0,500	0,630	0,630
Aluminium-Gusslegierungen < 10% Si Cast aluminium alloys < 10% Si	< 600 N/mm ²	Öl/Emulsion	220	0,160	0,200	0,250	0,315	0,315	0,400	0,500	0,630	0,630
Aluminium-Gusslegierungen > 10% Si Cast aluminium alloys > 10% Si	< 600 N/mm ²	Öl/Emulsion	180	0,160	0,200	0,250	0,315	0,315	0,400	0,500	0,630	0,630
Magnesium-Legierungen Magnesium alloys	< 450 N/mm ²	Luft / Air	260	0,160	0,200	0,200	0,250	0,315	0,400	0,400	0,500	0,630
Messing – kurzspanend Brass – short chipping	< 600 N/mm ²	Öl/Emulsion	270	0,160	0,200	0,200	0,250	0,315	0,400	0,400	0,500	0,630
Messing – langspanend Brass – long chipping	< 600 N/mm ²	Öl/Emulsion	180	0,125	0,160	0,160	0,200	0,250	0,315	0,315	0,400	0,500

8 x D – VHM-Spiralbohrer – Diamant beschichtet (mit Innenkühlung)

8 x D – Solid carbide drills – diamond coated (with internal coolant)

Werkstoff / Material	Härte / Hardness	Härte / Hardness	V _c [m/min] V _c [m/rev]	Durchmesser / Diameter [mm]						
				3 f [mm/U]	4 f [mm/U]	5 f [mm/U]	6 f [mm/U]	8 f [mm/U]	10 f [mm/U]	12 f [mm/U]
Aluminium und Al-Legierungen Aluminium and AL alloys	< 400 N/mm ²	Öl/Emulsion	260	0,160	0,200	0,200	0,250	0,315	0,400	0,400
Aluminium-Knetlegierungen Aluminium alloys – long chipping	< 450 N/mm ²	Öl/Emulsion	260	0,160	0,200	0,200	0,250	0,315	0,400	0,400
Aluminium-Gusslegierungen < 10% Si Cast aluminium alloys < 10% Si	< 600 N/mm ²	Öl/Emulsion	220	0,160	0,200	0,200	0,250	0,315	0,400	0,400
Aluminium-Gusslegierungen > 10% Si Cast aluminium alloys > 10% Si	< 600 N/mm ²	Öl/Emulsion	180	0,160	0,200	0,200	0,250	0,315	0,400	0,400
Magnesium-Legierungen Magnesium alloys	< 450 N/mm ²	Luft / Air	260	0,125	0,160	0,160	0,200	0,250	0,315	0,315
Messing – kurzspanend Brass – short chipping	< 600 N/mm ²	Öl/Emulsion	270	0,125	0,160	0,160	0,200	0,250	0,315	0,315
Messing – langspanend Brass – long chipping	< 600 N/mm ²	Öl/Emulsion	180	0,100	0,125	0,125	0,160	0,200	0,250	0,250

Vollhartmetall-Spiralbohrer

Empfohlener Kühlmitteldruck und Volumen

Solid carbide drills

Recommended coolant pressure and volume

Mindestdruck [bar]

Min. coolant pressure

Werkstoff / Material	Durchmesser / Diameter [mm]			
	5 [bar]	10 [bar]	15 [bar]	20 [bar]
Stahlbearbeitung Steel drilling	22	15	9	5
Aluminiumbearbeitung Aluminium drilling	25	20	15	10
Gussbearbeitung Cast drilling	38	30	20	18

Mindestvolumen [L/min]

Min. coolant volume

Werkstoff / Material	Durchmesser / Diameter [mm]			
	5 [L/min]	10 [L/min]	15 [L/min]	20 [L/min]
Stahlbearbeitung Steel drilling	3	6	7	9
Aluminiumbearbeitung Aluminium drilling	4	6	9	10
Gussbearbeitung Cast drilling	5	9	14	16



VHM-Spiralbohrer für gehärtete Stähle (ohne Innenkühlung)

Solid carbide drills for hardened steels (without internal coolant)

Material Härte / Material hardness		Durchmesser / Diameter [mm]								
		3	4	5	6	8	10	12	14	
V_c [m/min]		f [mm/U]	f [mm/U]	f [mm/U]	f [mm/U]	f [mm/U]	f [mm/U]	f [mm/U]	f [mm/U]	
50 ~ 55 HRC	14 - 22	[U/min]	1900	1430	1150	960	720	570	480	430
		[mm/U]	0,04 ~ 0,06	0,04 ~ 0,07	0,04 ~ 0,08	0,04 ~ 0,09	0,04 ~ 0,09	0,04 ~ 0,10	0,04 ~ 0,11	0,04 ~ 0,11
55 ~ 60 HRC	10 - 16	[U/min]	1330	1000	800	670	500	400	330	280
		[mm/U]	0,04 ~ 0,06	0,04 ~ 0,07	0,04 ~ 0,08	0,04 ~ 0,09	0,04 ~ 0,09	0,04 ~ 0,10	0,04 ~ 0,11	0,04 ~ 0,11
60 ~ 70 HRC	8 - 13	[U/min]	1250	850	750	630	480	380	320	270
		[mm/U]	0,04 ~ 0,06	0,04 ~ 0,07	0,04 ~ 0,08	0,04 ~ 0,09	0,04 ~ 0,09	0,04 ~ 0,10	0,04 ~ 0,11	0,04 ~ 0,11

Anwendungshinweise

Application notes 10xD / 15xD / 20xD / 25xD / 30xD

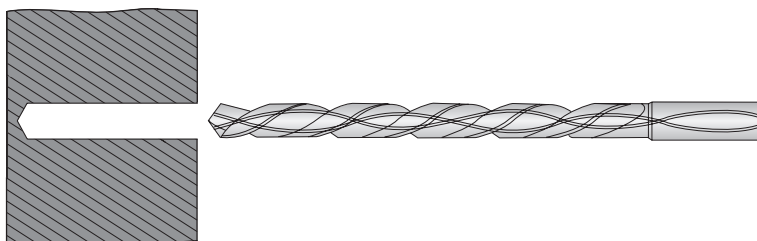
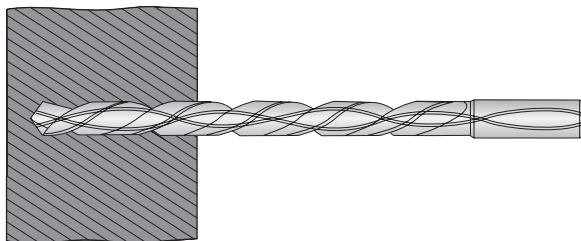
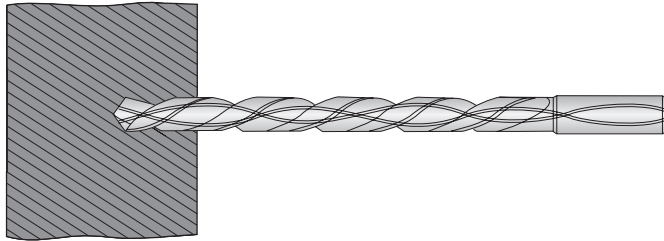
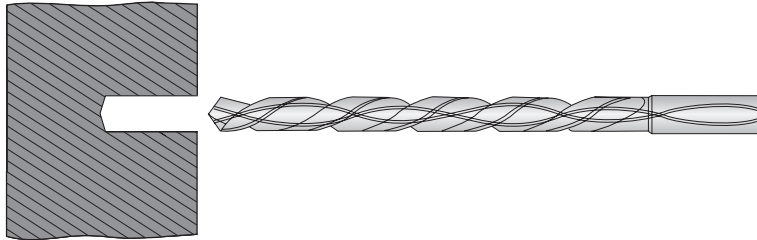

- Pilotbohrung setzen zwischen 3 und 5xD tief im Nenndurchmesser (Tol. +0,1 mm). Verwenden Sie hierzu z.B. unsere VHM Bohrer in 3 oder 5xD (Toleranzklasse m7) welche sich hierfür hervorragend eignen.**
Pre-Drilling should be done at the diameter +0.1 mm using 3 x D or 5 x D.
- Zur eigentlichen Bohrbearbeitung mit geringer Drehzahl in die Pilotbohrung einfahren (n = 300 U/min, Vf = 400 mm/min).**
For main drilling, proceed with low RPM for pre-drilled length. (RPM 300 U/min, Feed 400mm/min).
- Kurz vor dem Grund der Pilotbohrung (ca. 0,5 bis 1 mm), den Vorschub auf null reduzieren und die Drehzahl auf empfohlene Werte erhöhen (siehe Schnittwerttabelle). Ebenso sollte nun die Kühlung aktiviert werden.**
Just before the end of the pre-drilled hole, reduce feed to zero and increase the RPM according to the recommended cutting condition chart (see below).
- Nun mit der Bohrbearbeitung fortfahren, indem der Vorschub auf die empfohlenen Werte erhöht wird. Bohren möglichst in einem Zug ohne Spanbruchzyklus.**
Then continue to drill the hole by increasing the feed without step drilling.
- Nach Erreichen der Endbohrtiefe mit Drehzahl 300 U/min und Vorschubgeschwindigkeit 1000 mm/min aus der Bohrung herausfahren.**
When retracting drill from pre-drilled hole after drilling, RPM should be reduced to 300 U/Min and feed should be 1000 mm/min.
- Bei Durchgangsbohrungen, während des Austrittes den Arbeitsvorschub um ca. 50% reduzieren (f ca. 0,05 - 0,1 mm/U).**
When retracting the drill from the pre-drilled hole, when clear the feed can then be reduced by 50%. (f = ca. 0.05 - 0.1 mm/U).

ARNO®-Vollhartmetallfräser sind aus Feinstkorn-Hartmetall (Ultra-Micro-Grain) gefertigt. Die Korngrößen betragen 0–0,5 µm und je nach Ausführung sind sie mit verschiedenen Beschichtungen versehen (TiAlN, TiCN bzw. Diamant).

The ARNO® Solid carbide milling range is made of ultra micrograin carbide. The grain size is between 0–0.5 micron and coated depending on application with various coatings (TiAlN, TiCN or TIA70).



Feinstkorn-Hartmetall-Kornstruktur
Ultra-Micro-Grain, Korngrößen 0–0,5 µm

Finegrain-hardmetal structure
Ultra-micro-grain, grain size 0–0.5 micron

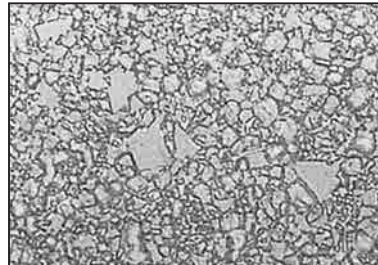

Allgemeine Hartmetall-Kornstruktur

General carbide structure

Pulvermetallurgische HSS-Fräser... die neue Pulverstahl-Generation! Extrem zäh und verschleißfest.
Powder metal HSS milling... the new powder steel generation! Very tough and wear resistant.

Ein Premium-HSS-Stahl der alle bisherigen Leistungsmerkmale in den Schatten stellt. Es ist gelungen, den Anteil eingeschlossener oxydischer Gaskomponenten und Schlackepartikel im Stahl auf ein Minimum zu reduzieren. Dieser besonders homogene Pulverstahl garantiert beste Zerspanungsergebnisse.

This PM-HSS-steel overshadows the performance of all previous results. We have succeeded to reduce the oxide components and particles in the steel to an absolute minimum. This especially pure powdersteel guarantees the best cutting performance.

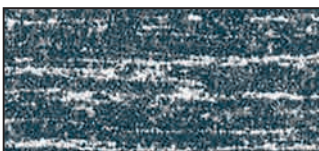

Herkömmlicher HSS-Fräser
• spröde Kornstruktur
• begrenzte Festigkeit

Original HSS-milling cutter
• brittle construction
• limited strength

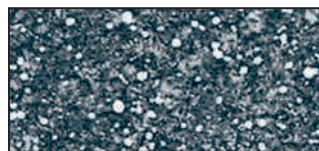

Pulvermetallurgischer HSS-Fräser
• feine Mikro-Kornstruktur
• gleichmäßige Kornverteilung
• höchste Festigkeit

Powder metallurgy HSS-milling cutter
• fine micro grain structure
• even grain formation
• highest strength

Im herkömmlich gegossenen Schnellarbeitsstahl sind die Karbidzeilen häufig so groß, dass es auf die Menge eingeschlossener ca. 10 bis 20 µm großer Schlackenpartikel meist nicht ankommt. Die oben abgebildete Darstellungen zeigen deutlich, dass im pulvermetallurgischen Stahl die Karbide wesentlich kleiner (ca. 1 bis 3 µm) sind. Dadurch wird der Einschluss von Schlackepartikeln nur in ganz geringem Maße ermöglicht.

Das Resultat: Ein sehr reiner Stahl, der das Risiko des Werkzeugversagens aufgrund metallischer Einschlüsse stark reduziert.

In traditional high speed steel the grain size is often so big, that the amount of 10–20 µm larger particles makes no difference. The above pictures shows clearly that in powder steel the grain size is much smaller (approx 1–3 µm). Therefore the contamination by particles is much reduced.

The Result: A very clean steel, which strongly reduces the risk of tool breakage due to contamination.

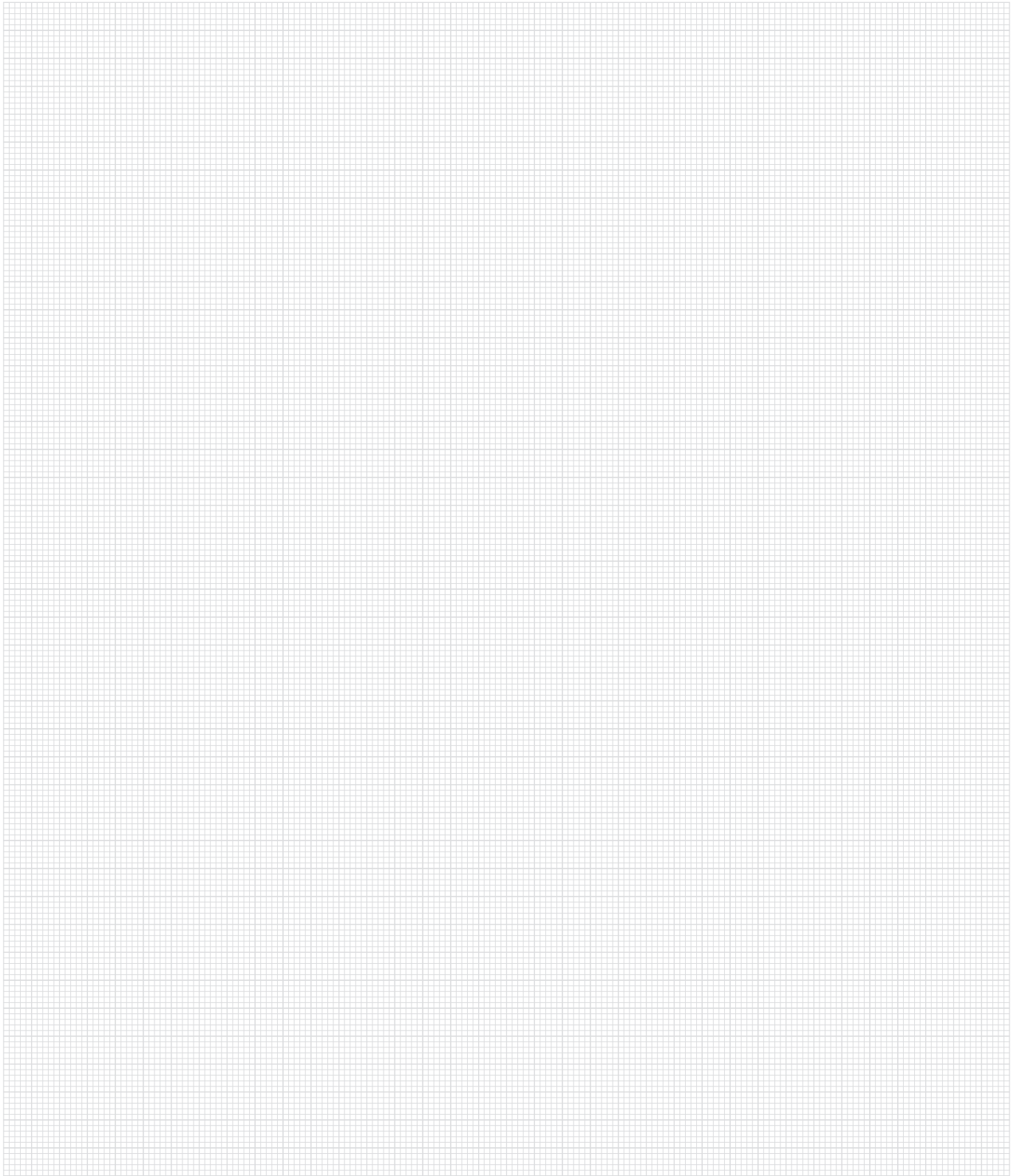

ARNO[®]
WERKZEUGE

Weitere Informationen finden Sie unter:
For more information see:

www.arno.de

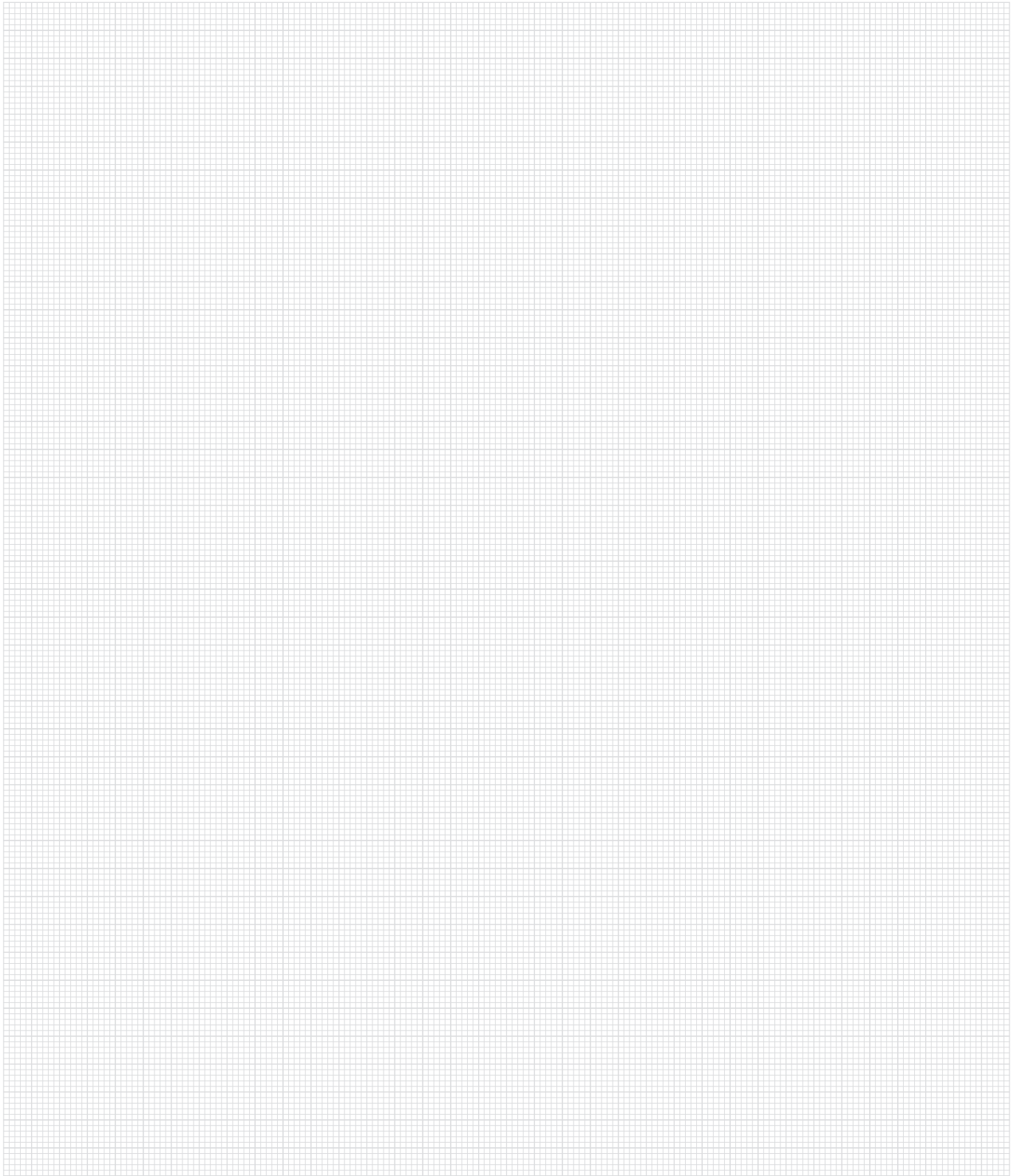

ARNO[®]
WERKZEUGE

Weitere Informationen finden Sie unter:
For more information see:

www.arno.de

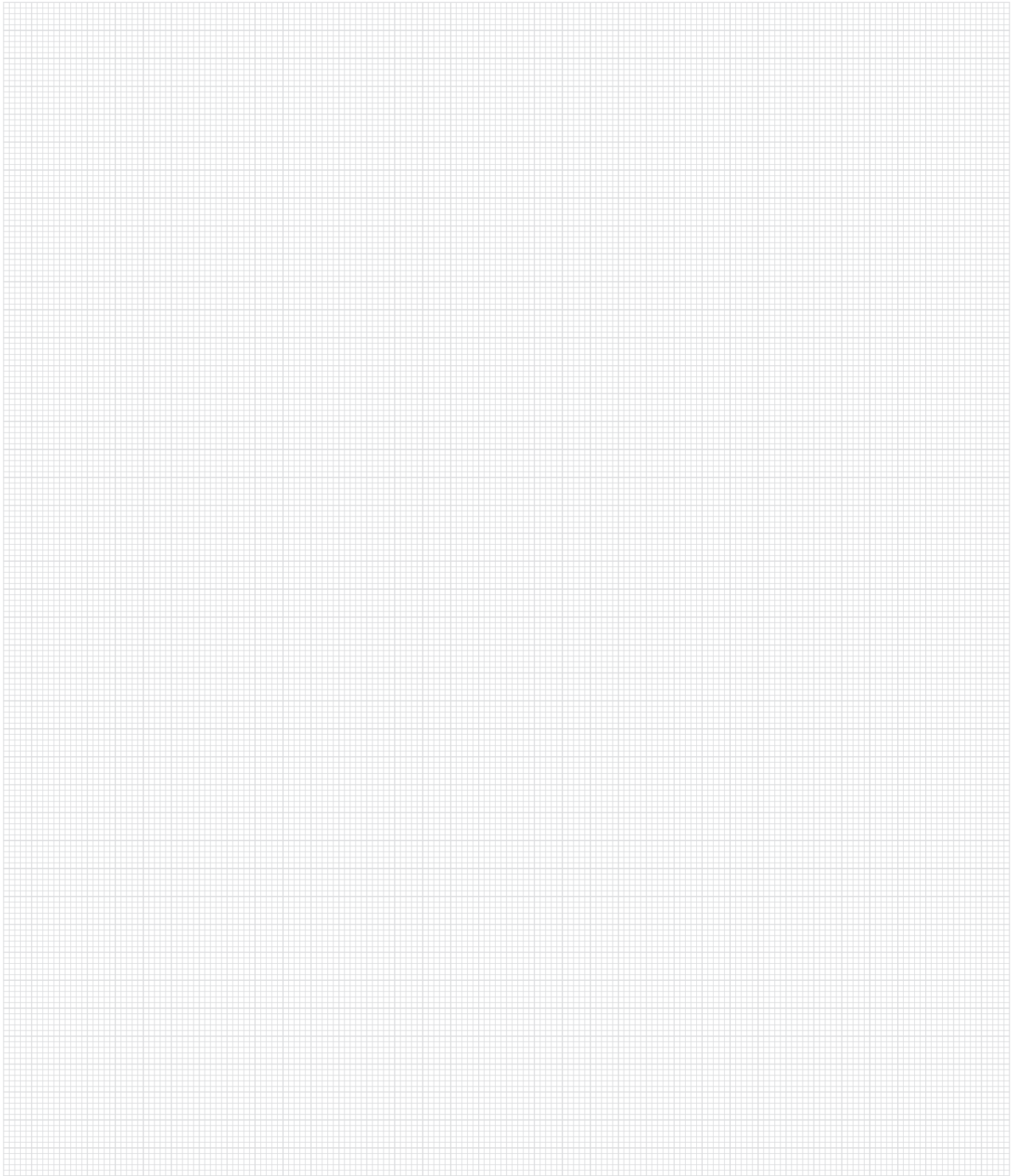

ARNO[®]
WERKZEUGE

Weitere Informationen finden Sie unter:
For more information see:

www.arno.de

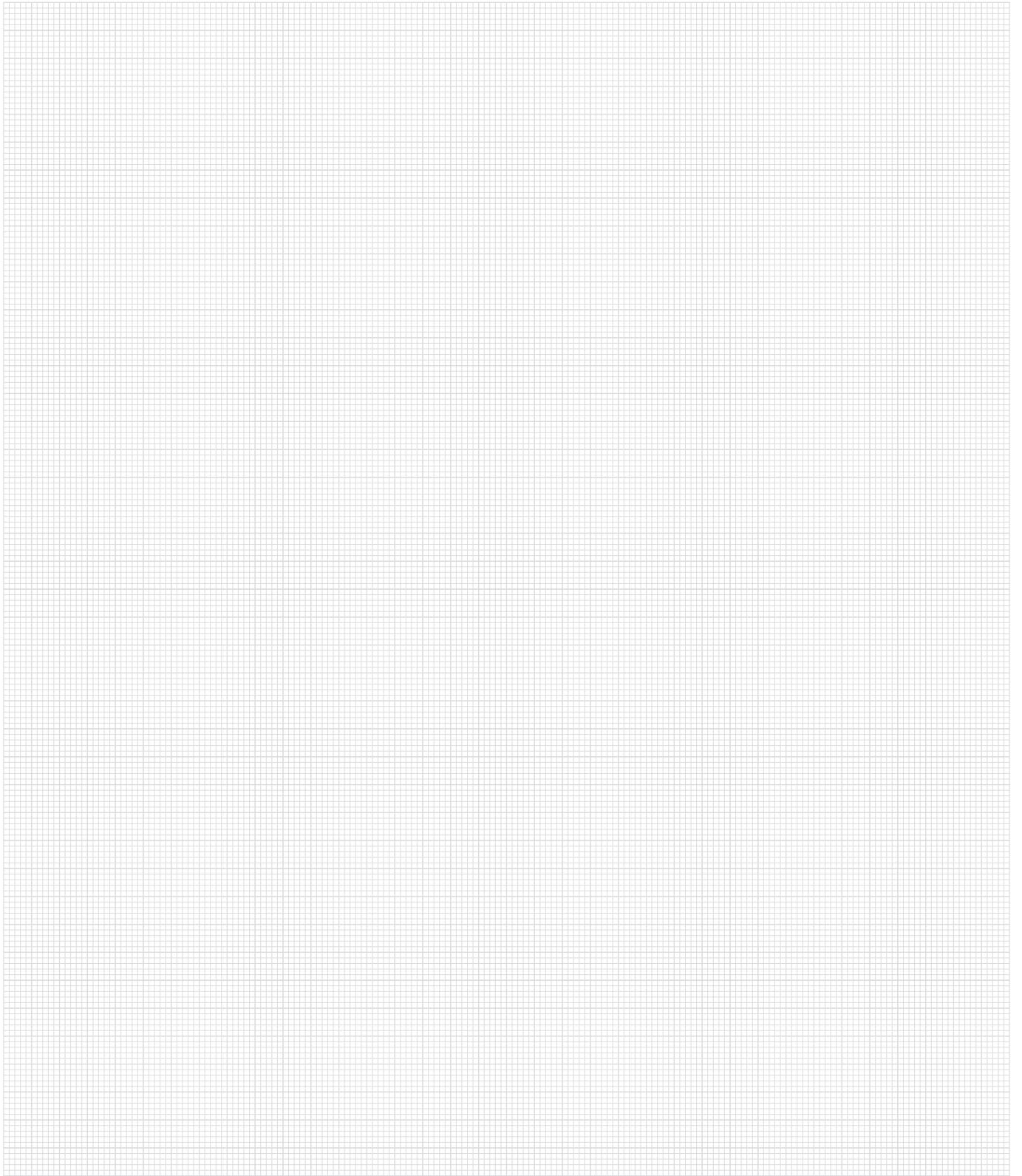

ARNO[®]
WERKZEUGE

Weitere Informationen finden Sie unter:
For more information see:

www.arno.de

We have a passion for precision.

Mit Leidenschaft und Begeisterung den Herausforderungen unserer Kunden zu begegnen, zu tüfteln, zu entwickeln und präzise zu fertigen – das macht ARNO[®]-Werkzeuge aus. Rund 70 Jahre Erfahrung fließen in jedes unserer Werkzeuge. Das ist zertifizierte Qualität und Präzision auf höchstem Niveau.

With passion and enthusiasm we face the challenges of our customers, to modify, develop and precisely manufacture – this is the way of ARNO[®]-Werkzeuge. Every single tool contains the knowledge and experience of over 70 years traditional tool manufacturing. That is proven quality and precision at the highest level.

ZERTIFIKAT ♦ CERTIFICATE ♦ 認證證書 ♦ СЕРТИФИКАТ ♦ CERTIFICADO ♦ CERTIFICAT



ZERTIFIKAT

Die Zertifizierungsstelle
der TÜV SÜD Management Service GmbH
bescheinigt, dass das Unternehmen



We have a passion for precision.

Karl-Heinz Arnold GmbH
Karlsbader Straße 4, D-73760 Ostfildern

für den Geltungsbereich

**Konstruktion, Lagerung und Vertrieb von
Zerspanungswerkzeugen und Spannzeugen**

ein Qualitätsmanagementsystem
eingeführt hat und anwendet.

Durch ein Audit, Bericht-Nr. **70013372**
wurde der Nachweis erbracht, dass die Forderungen der

ISO 9001:2008

erfüllt sind. Dieses Zertifikat ist gültig in Verbindung
mit dem Hauptzertifikat bis **2015-11-11**
Zertifikat-Registrier-Nr. **12 100 21067/01 TMS**



München, 2012-12-03



QMS-TGA-ZM-07-92

TÜV SÜD Management Service GmbH • Zertifizierungsstelle • Fidlerstraße 65 • 80339 München • Germany





Werkzeuge und Schneideinsätze zum Ein- und Abstechen

Tools and inserts for parting and grooving



Werkzeuge und Wendeschneidplatten zum Drehen und Gewindedrehen

Tooling and indexable inserts for turning and threading



Werkzeuge und Wendeschneidplatten zum Fräsen und Gewindefräsen

Milling cutters and indexable inserts for milling and thread milling



Werkzeuge und Wendeschneidplatten zum Bohren

Drilling tools and indexable inserts for drilling



Fordern Sie unsere weiteren Broschüren oder den Gesamtkatalog an.
For further information please ask for our complete catalogue.



Karl-Heinz Arnold GmbH
Karlsbader Str. 4
D-73760 Ostfildern

Tel.: +49 (0)711 34 802 0
Fax: +49 (0)711 34 802 130
bestellung@arno.de
anfrage@arno.de
www.arno.de

ARNO (UK) Limited | Unit 9, 10 & 11, Sugnall Business Centre | Sugnall, Eccleshall | Staffordshire | ST21 6NF
☎ +44 01785 850 072 | 📠 +44 01785 850 076 | sales@arno.de | www.arno-tools.co.uk

ARNO Italia S.r.l | Via J.F. Kennedy 19 | 20871 Vimercate (MB)
☎ +39 039 68 52 101 | 📠 +39 039 60 83 724 | info@arno-italia.it | www.arno-italia.it

ARNO-Werkzeuge USA LLC | 1101 W. Diggins St. | US-60033 Harvard, Illinois
☎ +1 815 943 4426 | 📠 +1 815 943 7156 | info@arnousa.com | www.arnousa.com

ARNO RU Ltd. | Krassnaja Ul. 38 | RU-600015 Vladimir
☎/📠 +7 4922 541125 | COT +7 4922 541135 | info@arnoru.ru | www.arnoru.ru

ARNO Werkzeuge S.E.A. PTE. LTD. | 25 International Business Park | #04 – 70A German Center | SG-609916 Singapore
☎ +65 65130779 | 📠 +65 68970042 | info@arno.com.sg | www.arno.com.sg